

Art-Nr.1979

WBU m.3 Schubladen

- | | | | |
|-----------|-------------------------------|------|------------------------------|
| (DE) (AT) | Montageanleitung | (IE) | Assembly instructions |
| (FR) | Notice de montage | (DK) | Monteringsvejledning |
| (PT) | Instruções de montagem | (SI) | Navodilo za montažo |
| (NL) | Montagehandleiding | | |

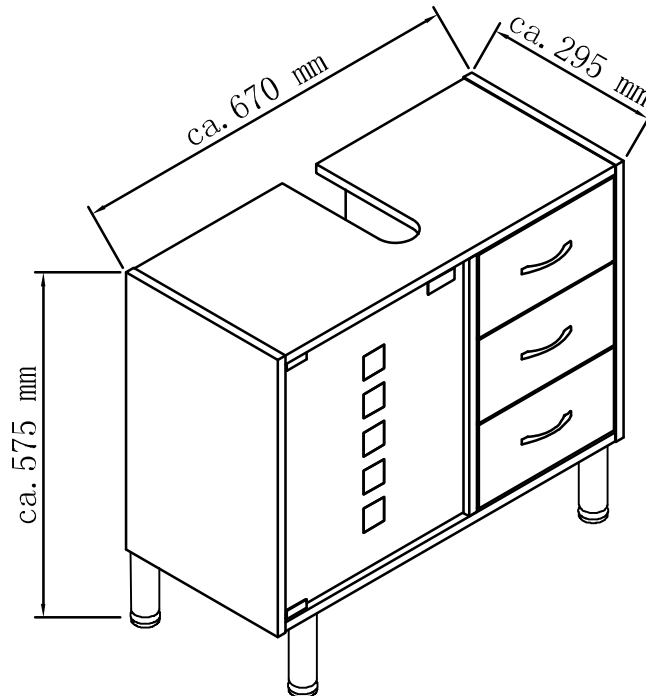

(DE) (AT) **Achtung:** Bei mangelhafter Montage besteht Gefahr für die Sicherheit. Wir empfehlen die Montage nur durch fachkundiges Personal.

(FR) **Attention:** En cas de montage incorrect, il y a risque pour la sécurité. Nous recommandons de ne faire effectuer le montage que par du personnel qualifié.

(PT) **Atenção:** Em caso de montagem incorrecta existe perigo relativamente à segurança. Recomendamos que a montagem seja efectuada apenas por pessoal técnico especializado.

(NL) **Opgelet:** bij een gebrekkige montage bestaat gevaar voor de veiligheid. Wij raden aan om de montage alleen door vakkundig personeel te laten uitvoeren.

(IE) **Warning:** Deficient assembly causes safety risks. We recommend having the assembly done only by qualified personnel.

(DK) **Vigtigt:** Mangelfuld montering indebærer en sikkerhedsrisiko. Vi anbefaler, at du lader monteringsarbejdet udføre af en fagmand.

(SI) **Pozor:** Pri pomanjkljivi montaži je ogrožena varnost. Priporočamo, da montažo opravi le strokovno osebje.

(DE) (AT) Bitte nur mit einem Staubtuch oder einem feuchten Lappen reinigen. Keine scheuenden Putzmittel verwenden!

(FR) Ne nettoyer qu'avec un chiffon à poussière ou un chiffon humide. Ne pas utiliser de produit à récurer !

(PT) Limpar apenas com um pano suave ou humedecido. Não utilizar qualquer detergente abrasivo!

(NL) A.u.b. alleen reinigen met een stofdoek of een vochtige lap. Gebruik nooit schurende poetsmiddelen!

(IE) Please do only clean with a duster or damp cloth. Do not use any scouring agents!

(DK) Rengjør venligst kun med en støvduk eller et fugtig trøkle. Ikke bruk skurende pussemidler!

(SI) Èistite, prosimo, le s krpo za prah ali z vlažno krpo. Ne uporabljajte nobenih grobih èistil!

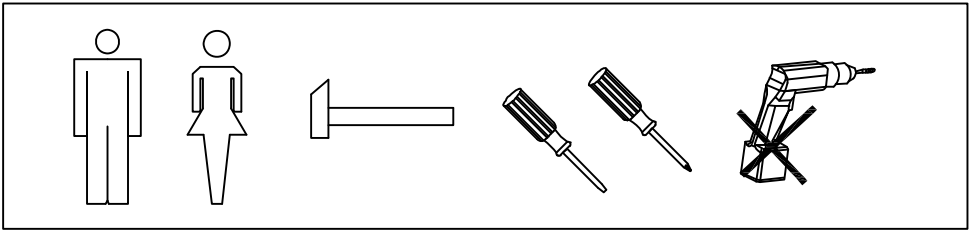

A	1	ca. 475x295x15
B	1	ca. 475x295x15
X	1	ca. 444x255x15
D	1	ca. 636x294x15
E	1	ca. 636x294x15

F	1	ca. 437x348x3
U	3	ca. 737x80x12
V	3	ca. 232x247x3
W	3	ca. 264x144x15

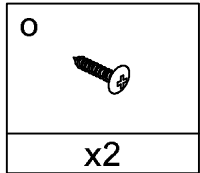
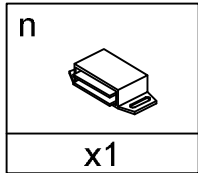
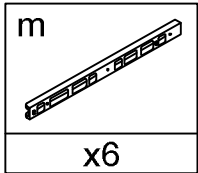
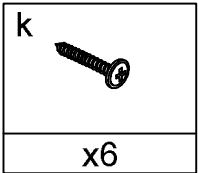
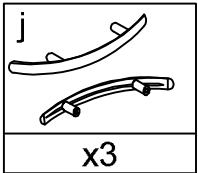
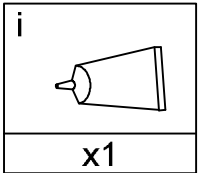
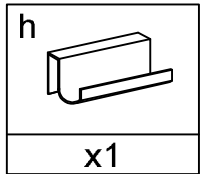
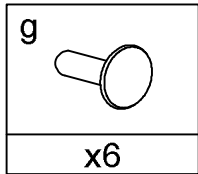
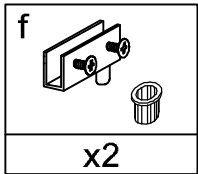
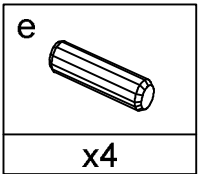
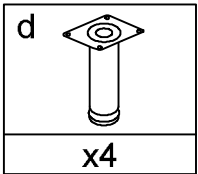
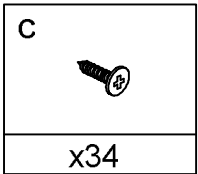
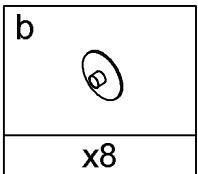
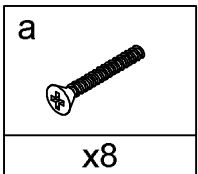
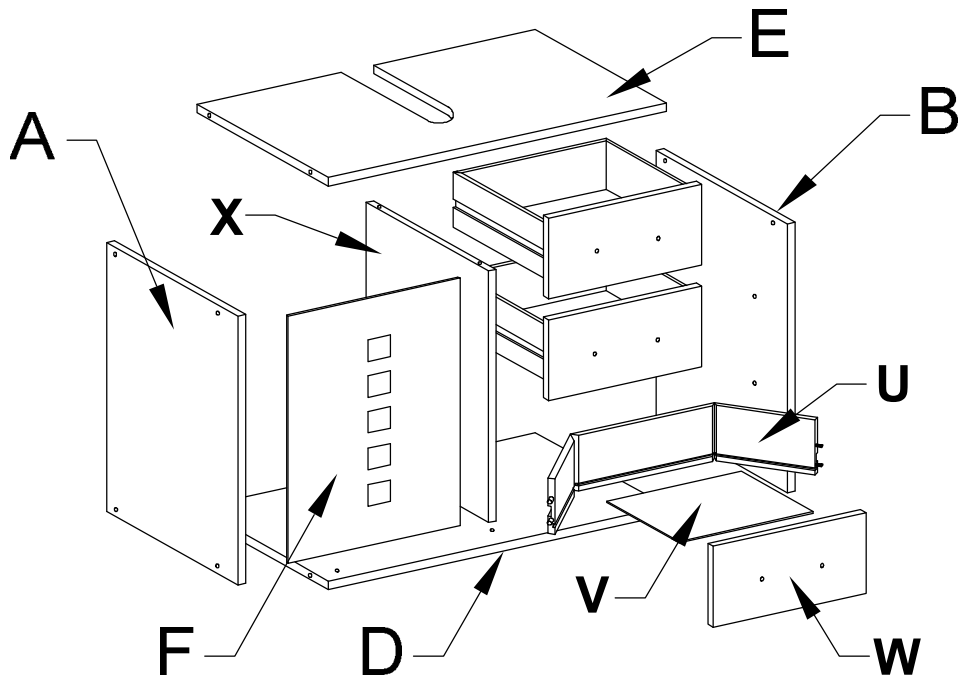

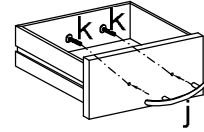
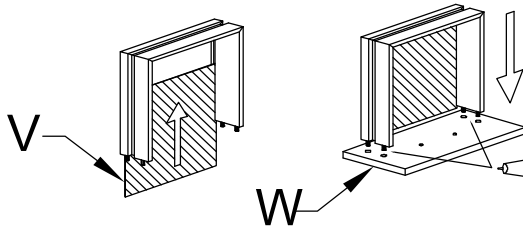
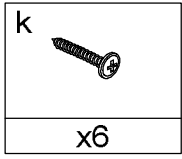
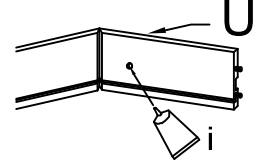
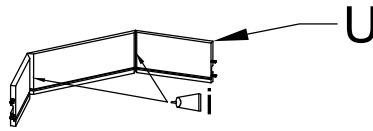
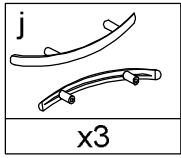
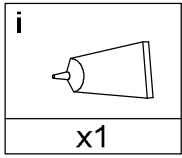

x3

1.

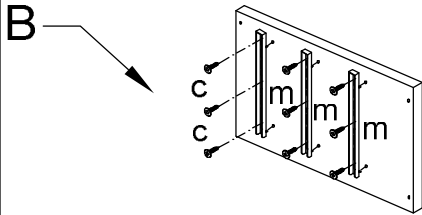
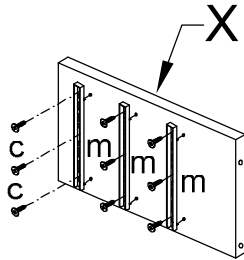
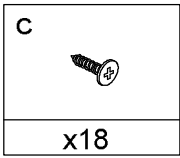
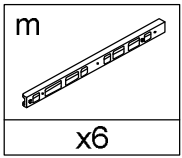

2.

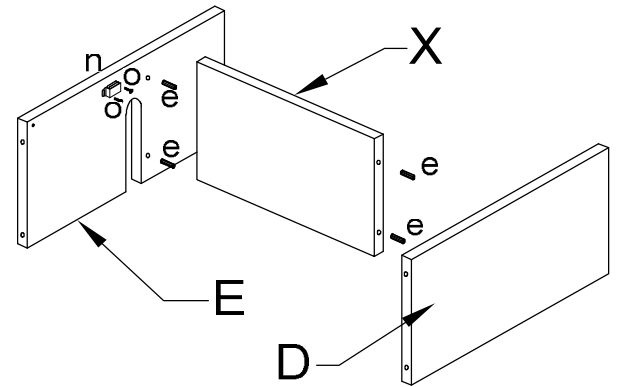
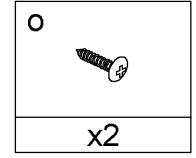
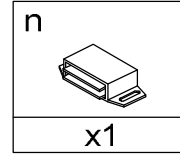
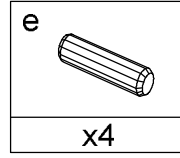

3.

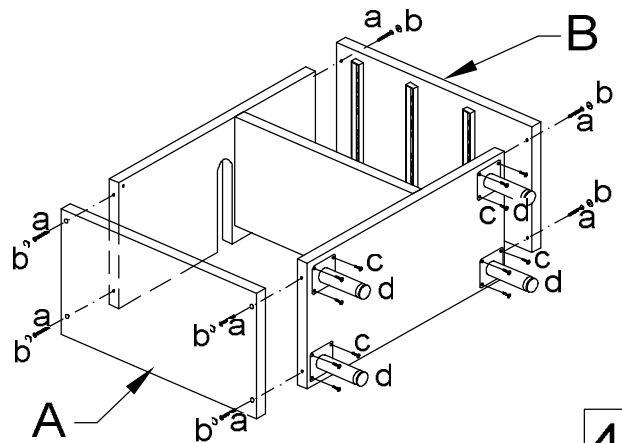
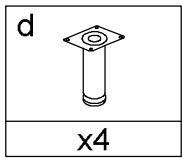
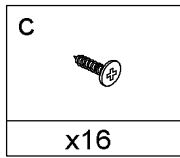
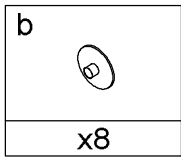
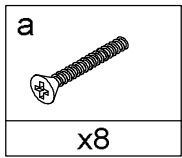

4.

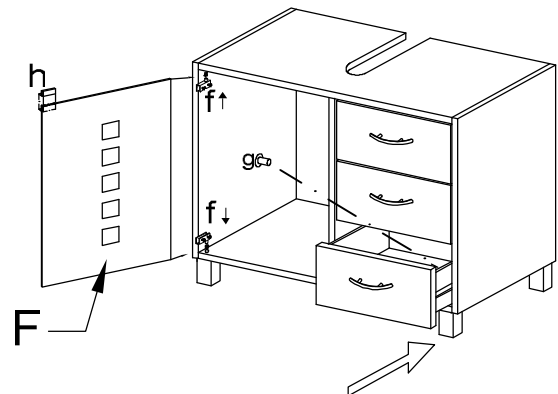
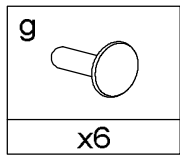
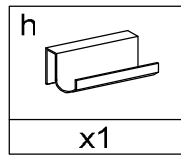
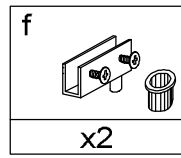

5.

Servicekarte

Art. Nr. 1979M

Sehr geehrter Kunde,

vielen Dank dass Sie sich für ein Produkt aus unserem Hause entschieden haben!

Sollte mal ein Teil fehlen oder beschädigt sein, können Sie uns dies jederzeit per Fax oder E-Mail mitteilen.
Für eine Reklamation verwenden Sie bitte dieses Formular und senden uns dies vollständig ausgefüllt zu.
Bitte fügen Sie unbedingt zu jeder Reklamation eine Kopie Ihres Kassenbeleges bei.

E-Mail: kundenservice-moebel@web.de

Fax: +49(0)7131 - 1 55 50 55

Reklamations Details

Anschrift	Name	Vorname	Strasse	Nr.	PLZ	Ort	Fax - Nr.:	Tel. Nr.:

Reklamation	Benötigte Teile *	Anzahl	Fehlerbeschreibung	Kaufdatum

***Bitte geben Sie die Ersatzteile-Nummer laut Kennzeichnung in der Aufbauanleitung an**

friboss Handelsgesellschaft mbH & Co. KG
Happelstrasse 43, 74074 Heilbronn