

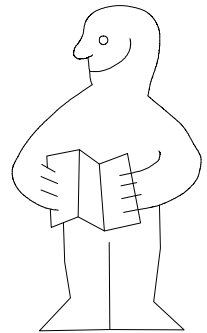

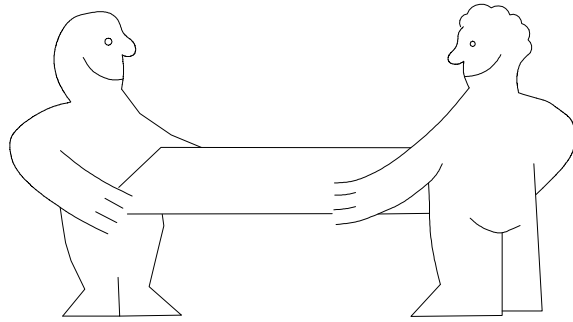

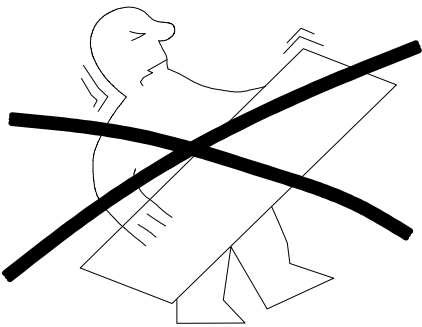

980479

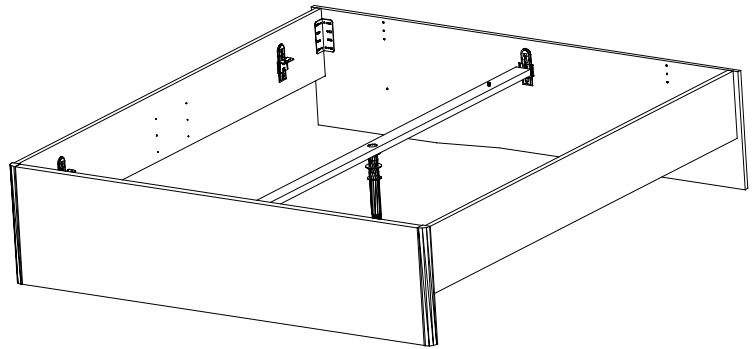
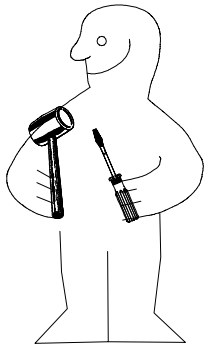
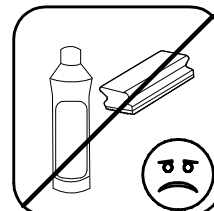
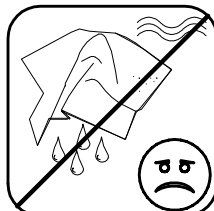
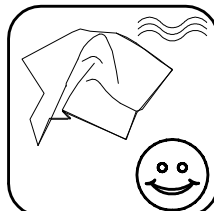
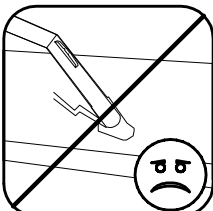
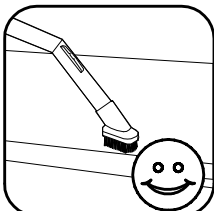
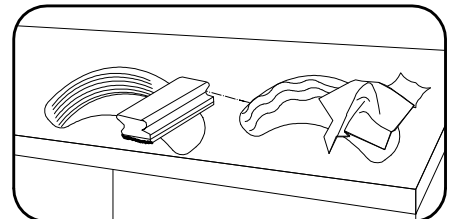
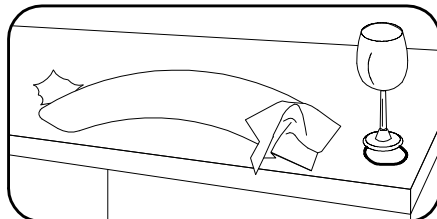
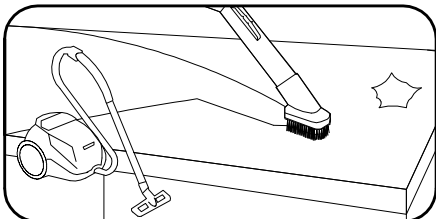
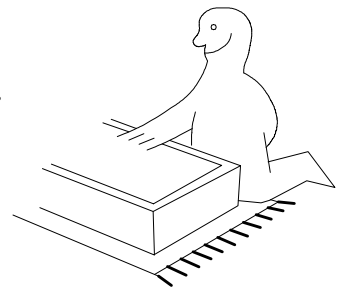
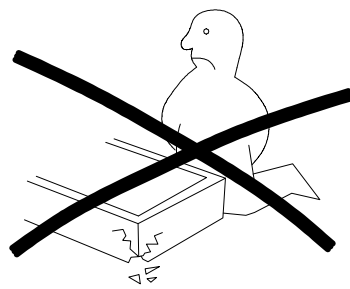
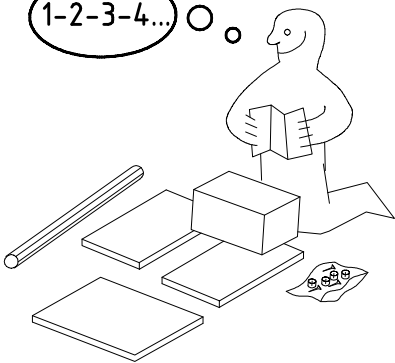
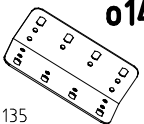

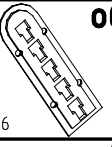
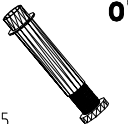

1-2-3-4...

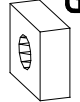
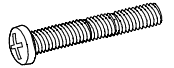
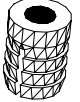

 111 135	014 4 x
 111 627	07 6 x
 111 626	06 6 x
 111625	09 1 x

 121 130	4 X 20 mm G22 16 x
 121 110	4,0 x 15 mm G23 20 x
 121 148	6,0 x 12 mm G4 6 x
 111634	09A 2 x

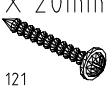
 129 407	US 4 x
 121 150	G6 4 x
 121 149	5,0 x 35 mm G51 4 x
 111 112	ϕ 10 x 13 mm H 6 x

 121 121	4 X 20mm SP20 16 x
 353 018	D ϕ 8 x 30 2 x

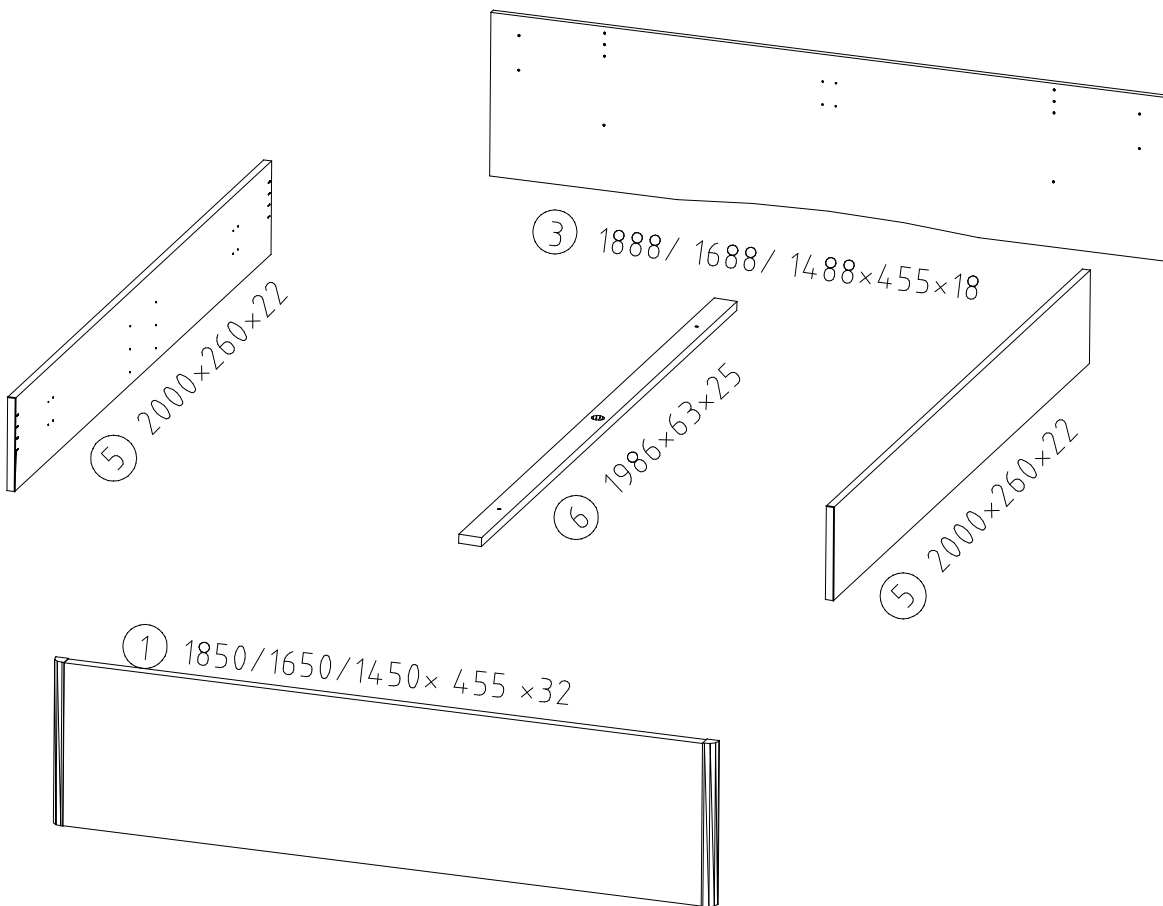
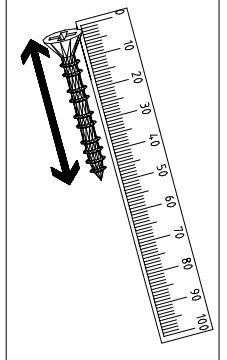
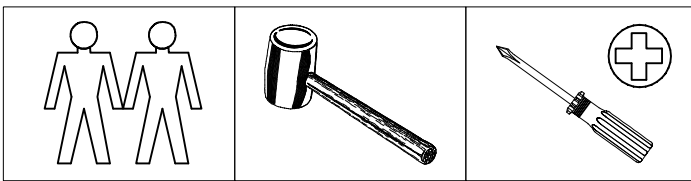
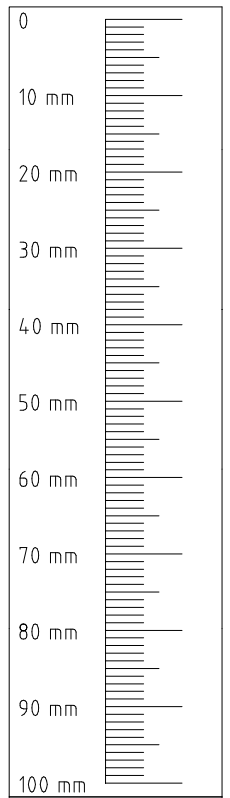

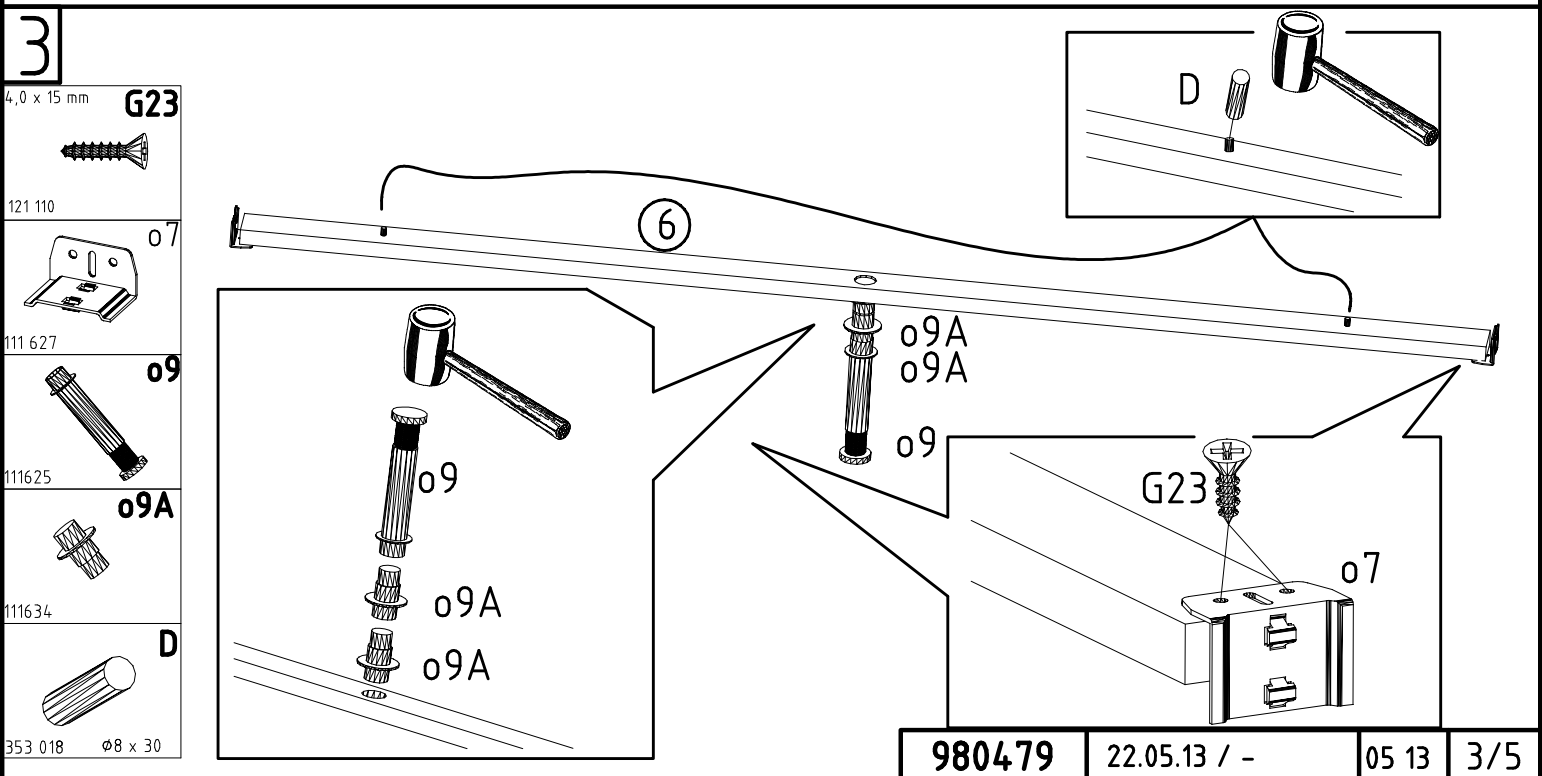
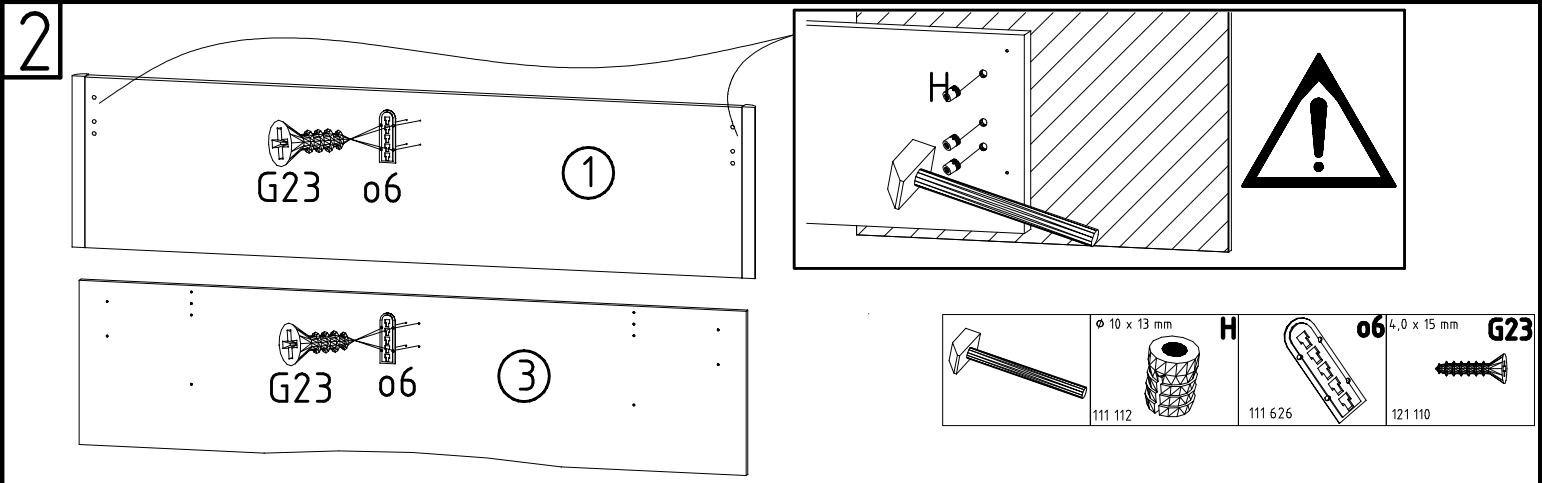
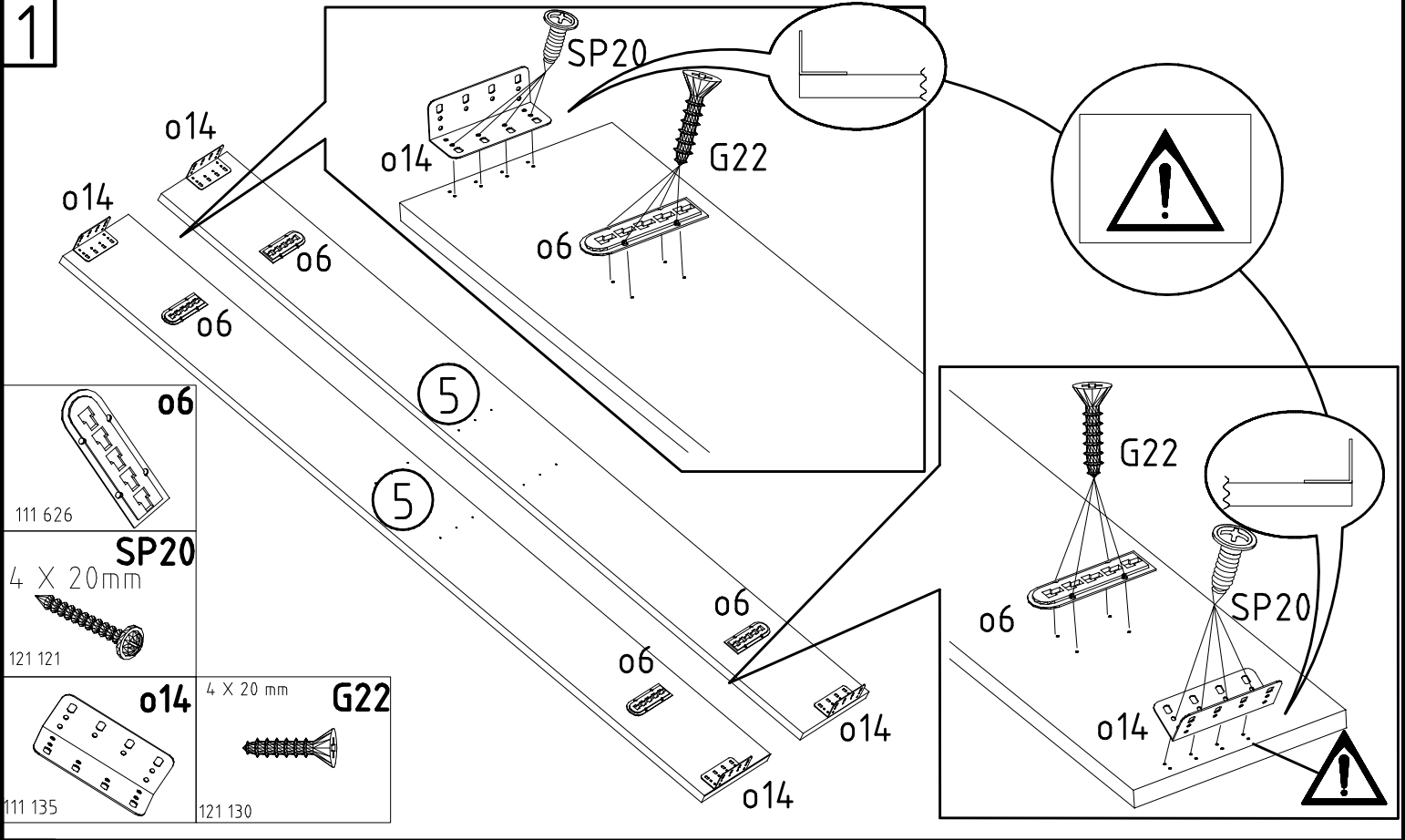

4

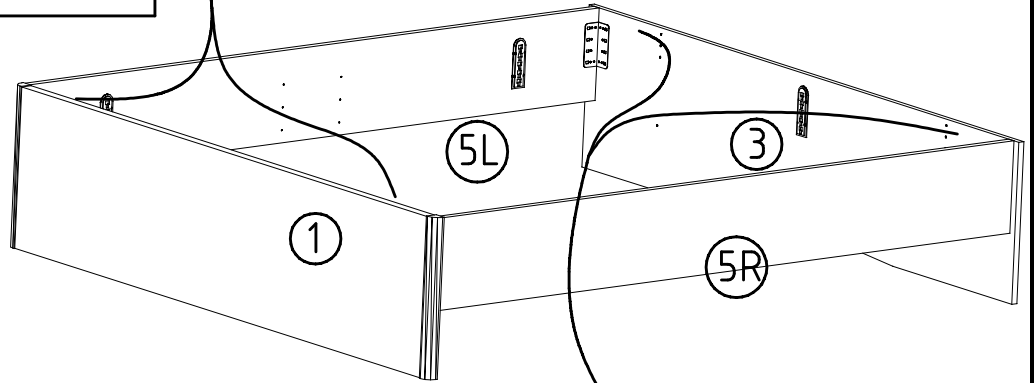
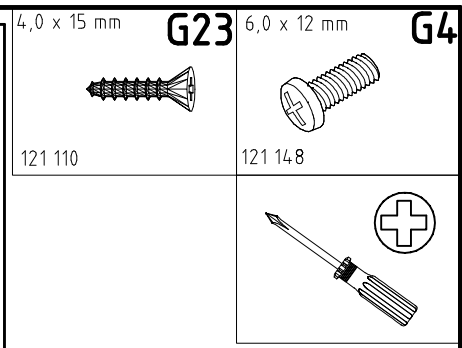
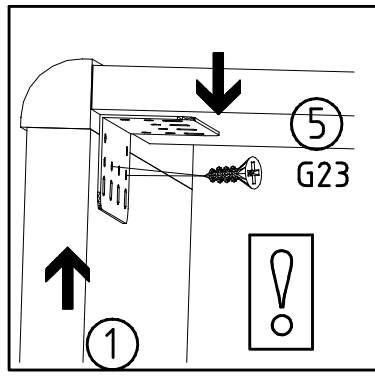
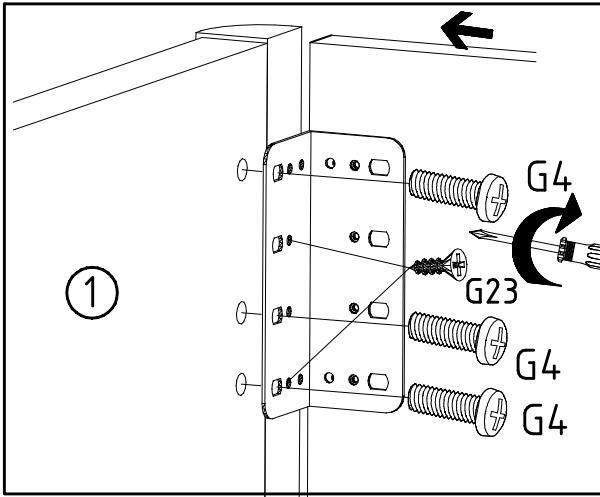

5

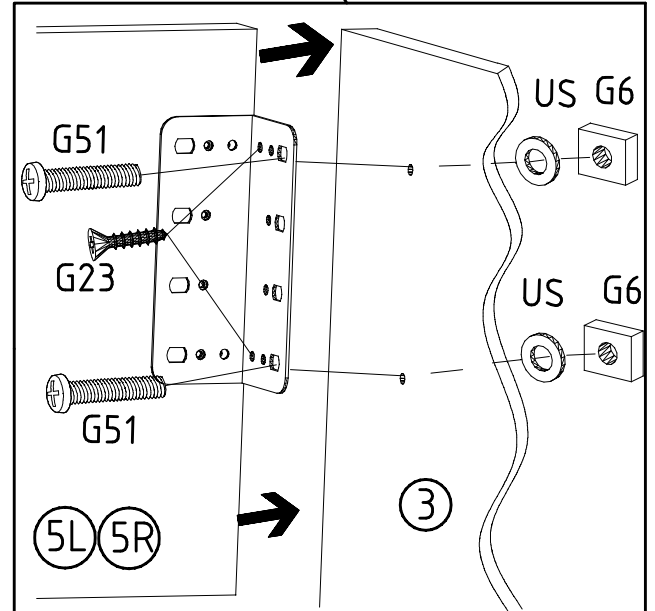
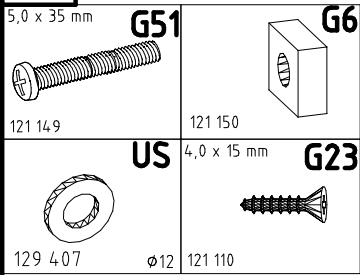

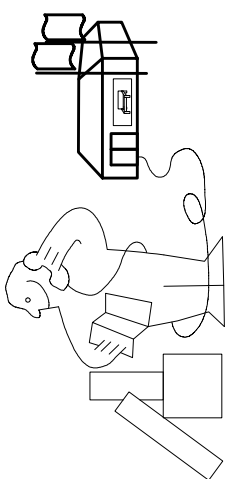
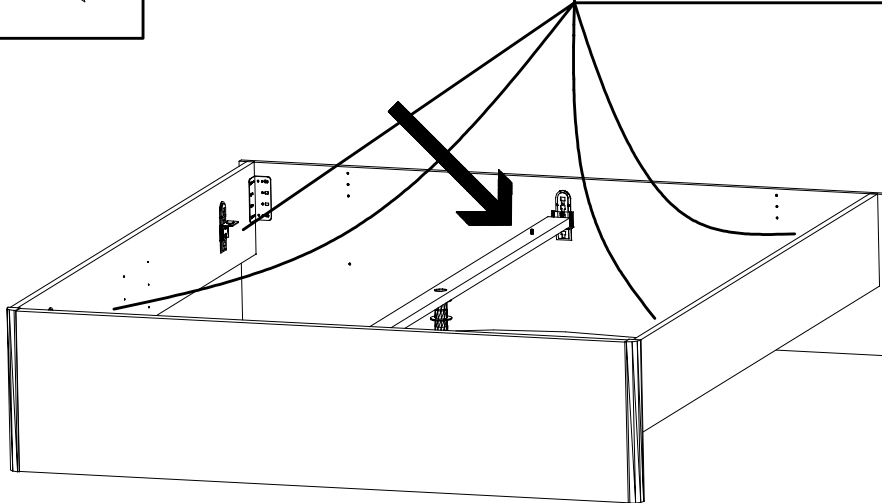
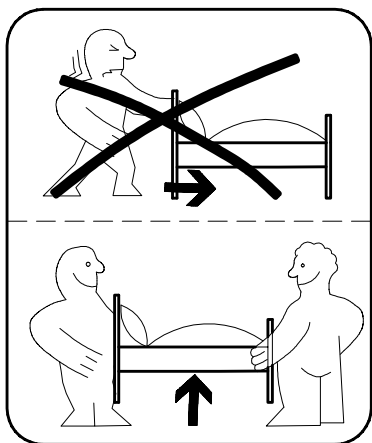
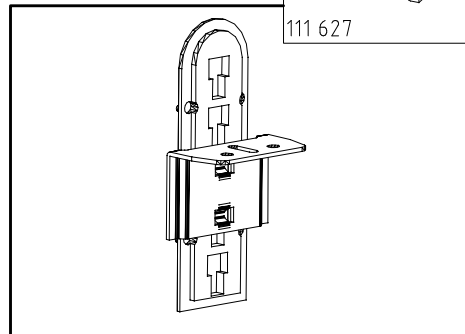
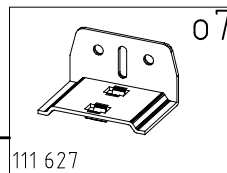
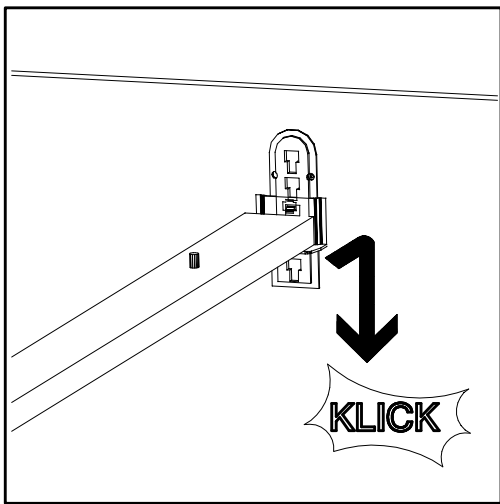

Modell/Model/Modèle

_____	_____	_____	_____	_____	_____
-------	-------	-------	-------	-------	-------

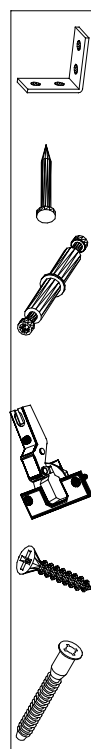
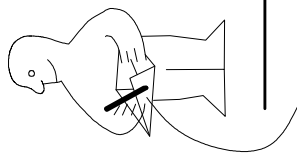
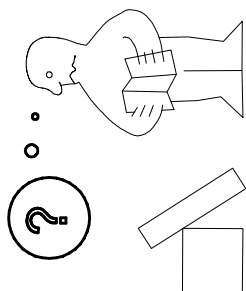
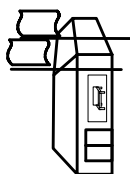
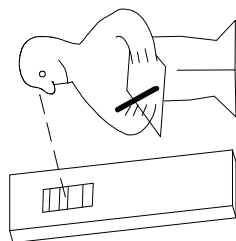

(121 370)	(G 1)	(4x)

Änderungen die dem technischen Fortschritt geschuldet sind, behalten wir uns vor!
Bei nicht vorschriftsmäßiger und/ oder nicht fachmännischer Montage wird bei Personen- und/ oder Sachschäden keinerlei Haftung übernommen.

WIMEX Wohnbedarf/ Import Export Handels GmbH/ Postfach 1407/ 49112 Georgsmarienhütte/ Germany
Tel.:(+49) 05401 8598 16/17 Fax.:(+49) 05401 8598 33 Mail: info@wimex-wohnbedarf.de