

980822

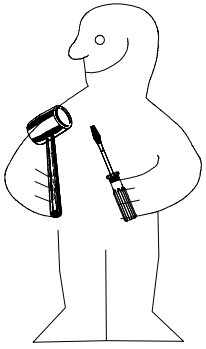

1.

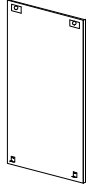

2.

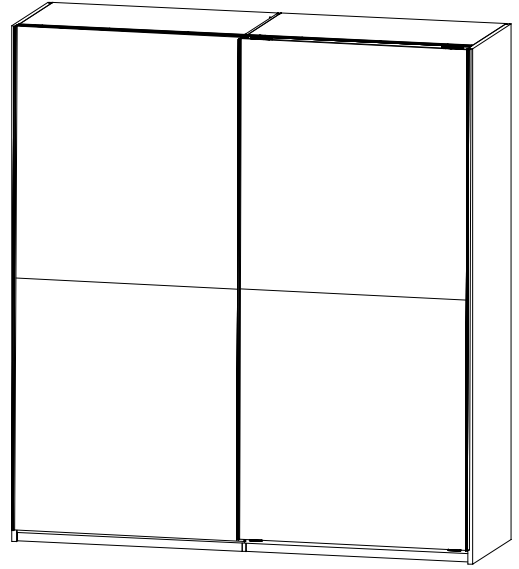
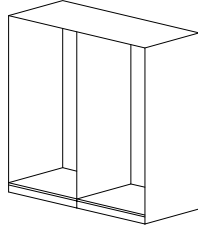

H 250

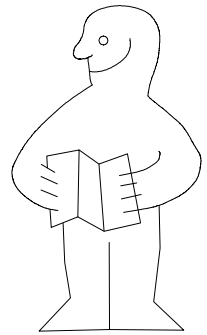
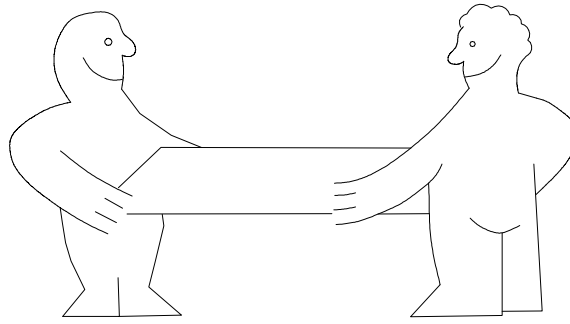
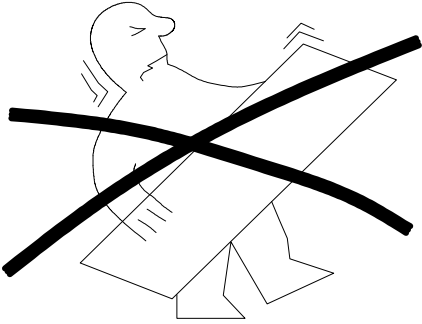

1-2-3-4... ○

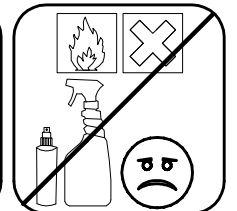
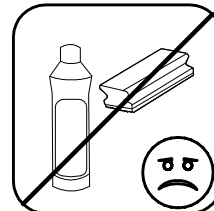
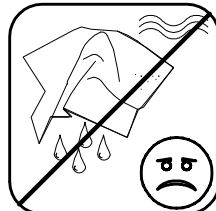
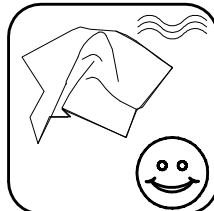
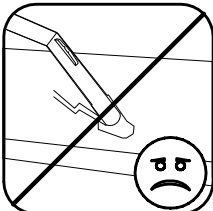
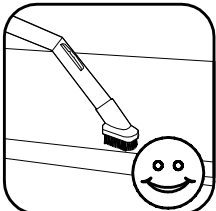
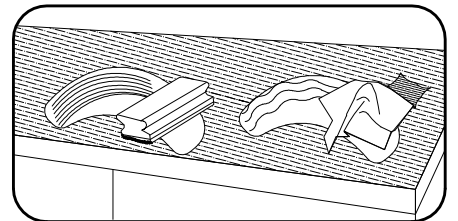
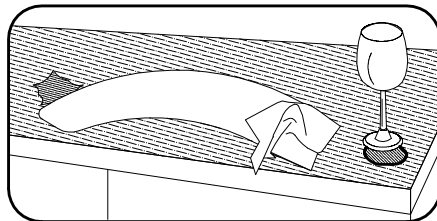
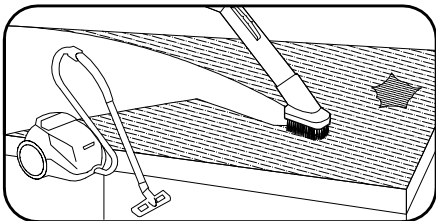
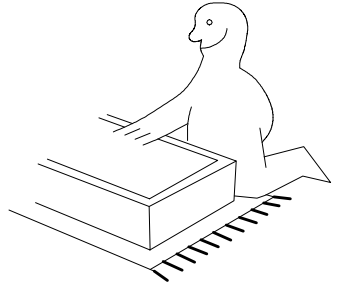
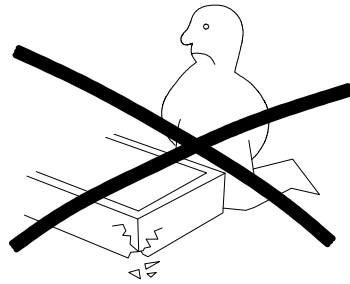
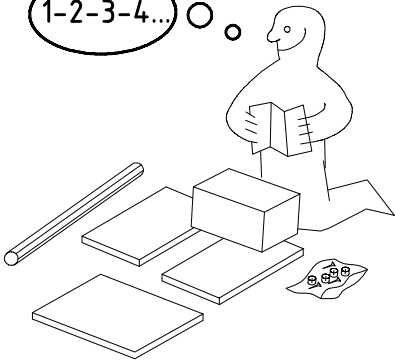







980822



26.01.10 / 01.06.12

06 12

1/8

 111 235	E 8x
 111 229 3,5 x 15 mm	F 8x
 121 370	G1 12x

 111 252	VB23 24x
 111 610 M6 x 10,5 mm	L7 12x
 112 055	T1 6x

 117 002	K2 6x
 100cm 112 400	K10 2x
 50cm 112 401	K11 1x

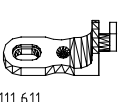
 111 611	J2 6x
--	-----------------

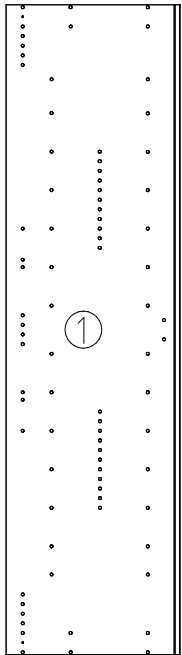
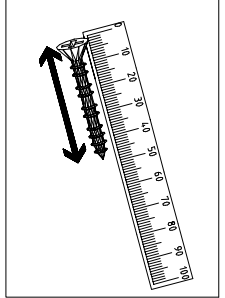
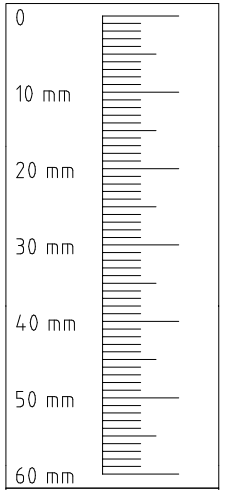

2160x577x15

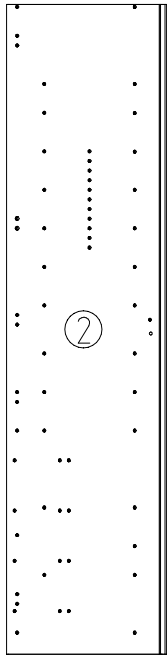

2x 2160x560x15

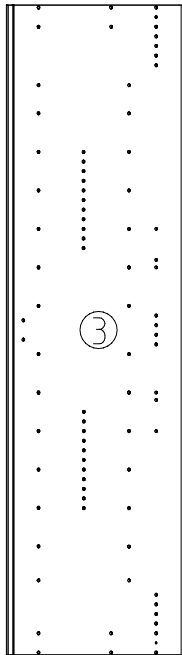

2160x607x15

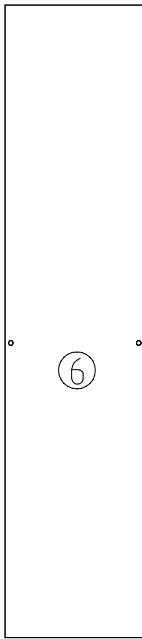

2078x484x2,5

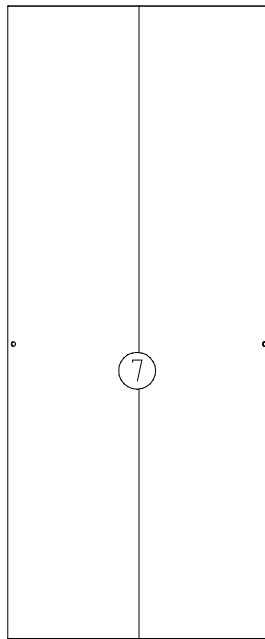

2x 2078x973x2,5



475x560x79

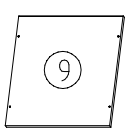

475x500x15

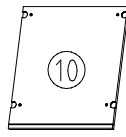

475x560x15

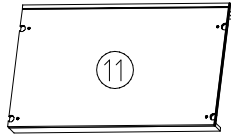

964x560x79

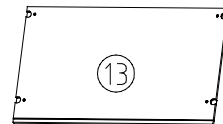

2x 964x560x15



2x 964x500x15

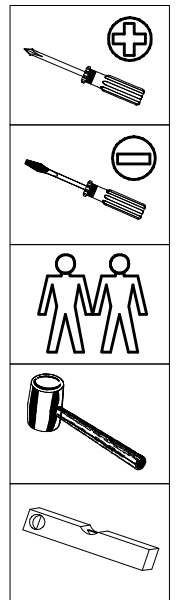

1

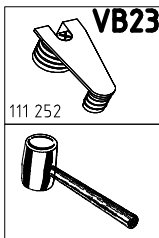
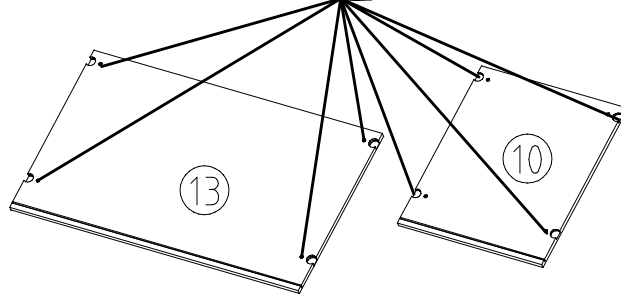
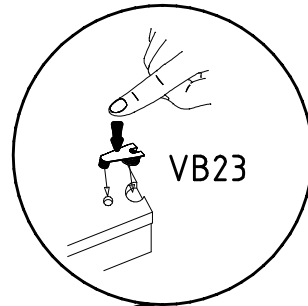
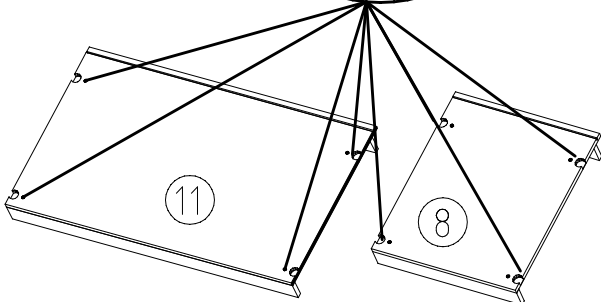
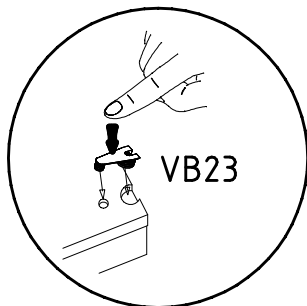

2

L7

K2

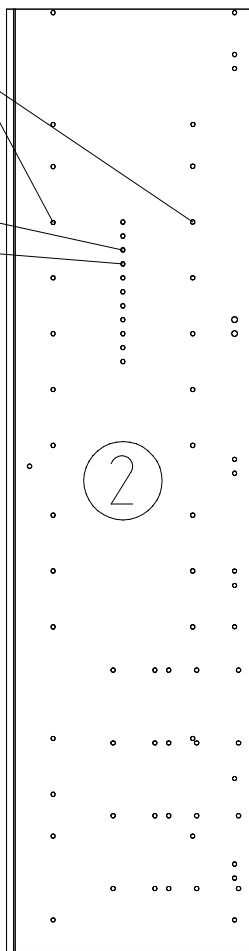

L7

K2

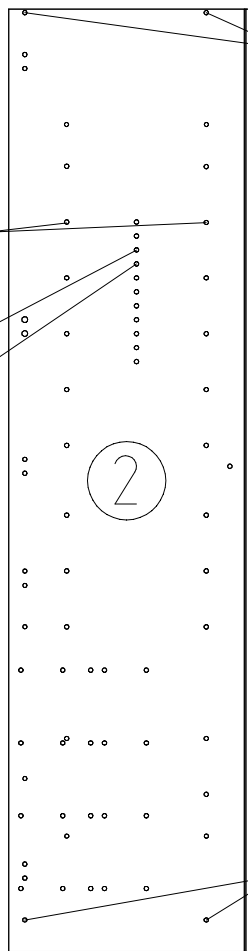

180°

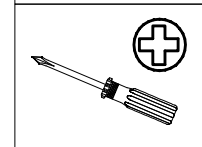
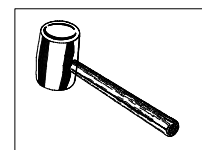
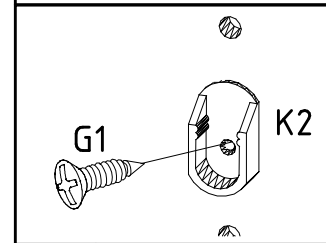
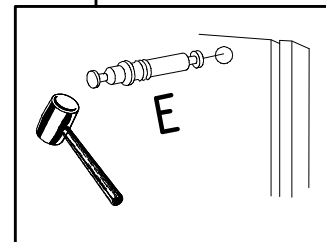

3



577

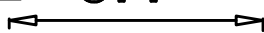

L7

K2

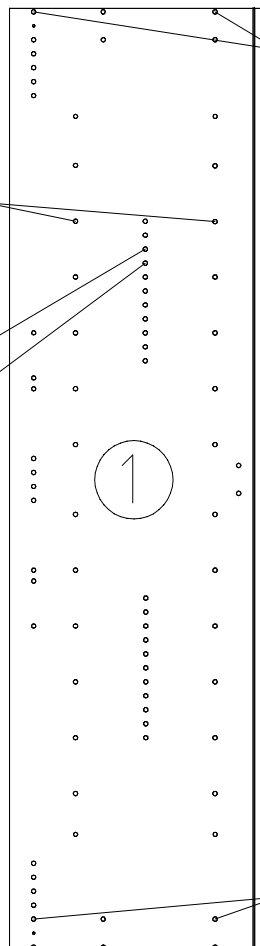

F

4



607

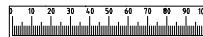

F

L7

K2

F

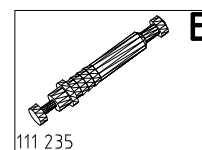
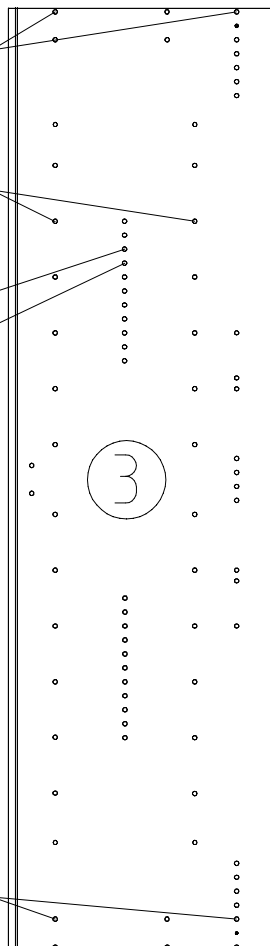

111 235

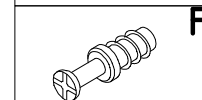

111 229

3,5 x 15 mm

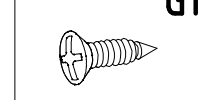

121 370

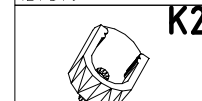

117 002

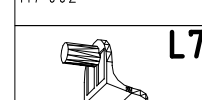

111 610

5

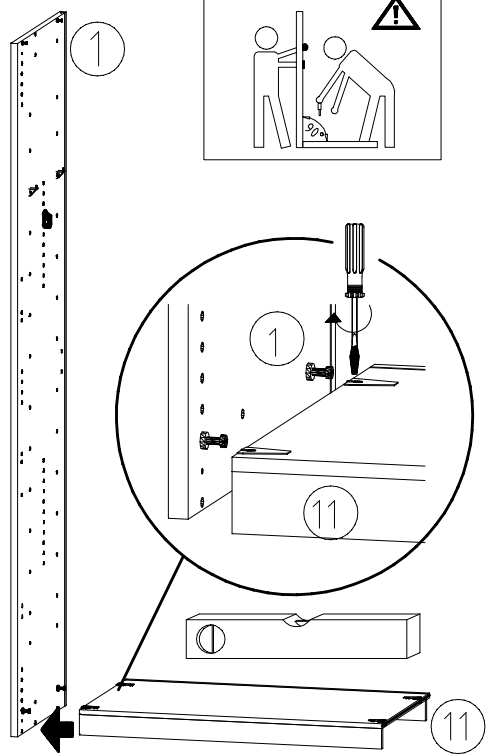
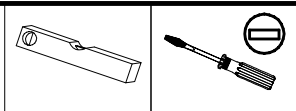

6

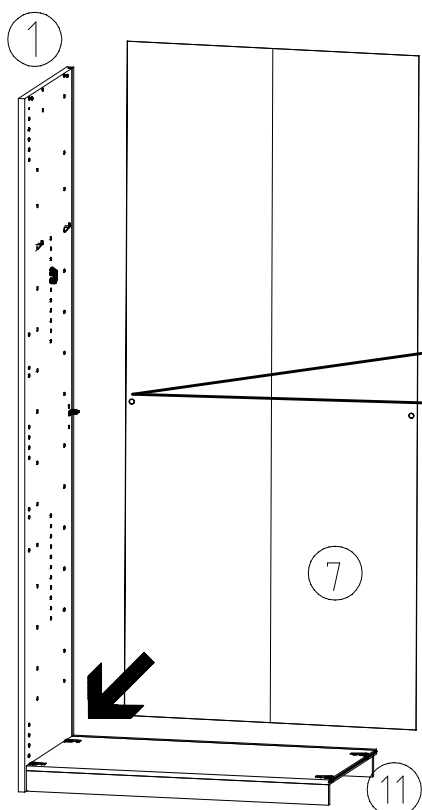
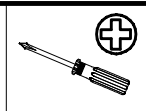

3,5 x 15 mm

G1



121 370

J2

M6 x 10,5 mm

T1

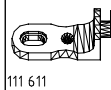

111 611



112 055

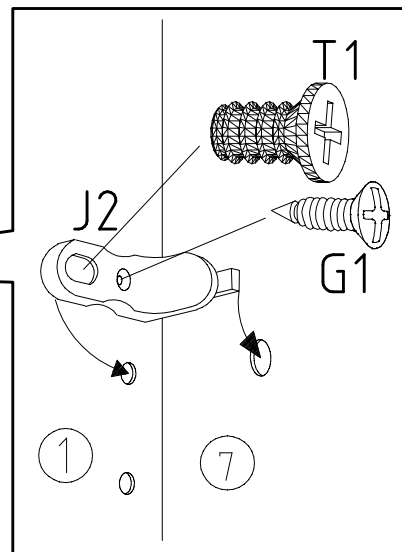

7

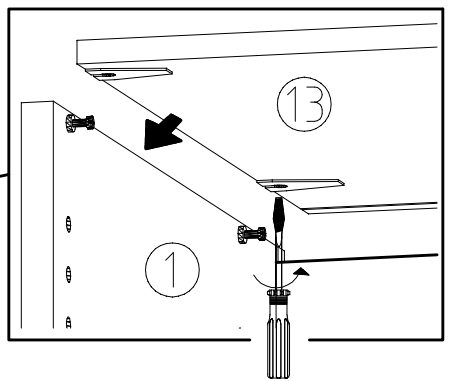
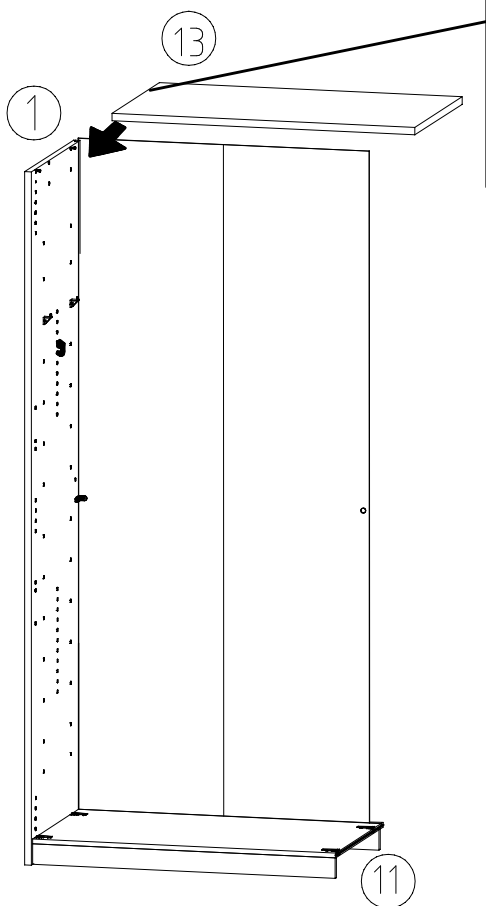
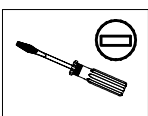

8

3,5 x 15 mm

G1



121 370

J2

M6 x 10,5 mm

T1

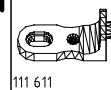

111 611



112 055

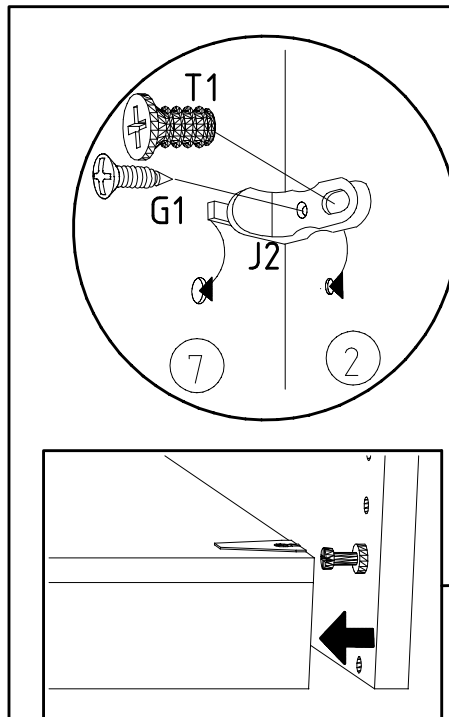
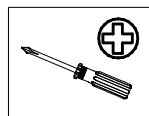

980822

26.01.10 / 01.06.12

06 12

4/8

9

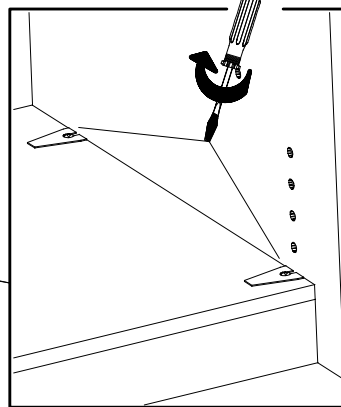
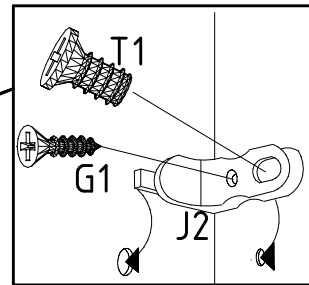
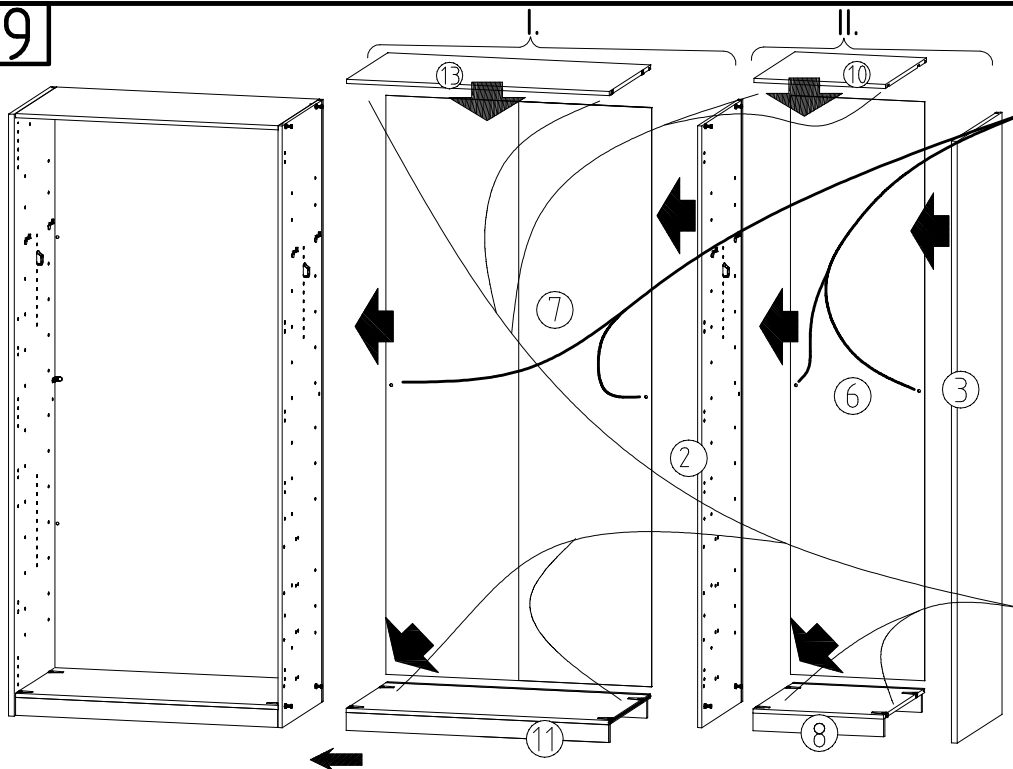

3,5 x 15 mm **G1**

121 370
M6 x 10,5 mm **T1**

112 055 **J2**

111 611

10

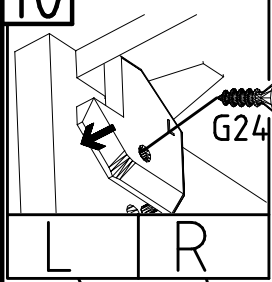

3,5 x 22 mm **G24**

121 004

SWH-SKL L

SWH-SKR R

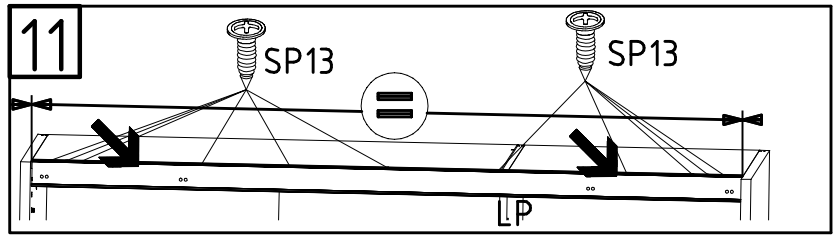
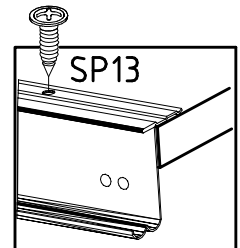

SP13

4 X 13mm

121 122

LP

1451/1940/2430/2920

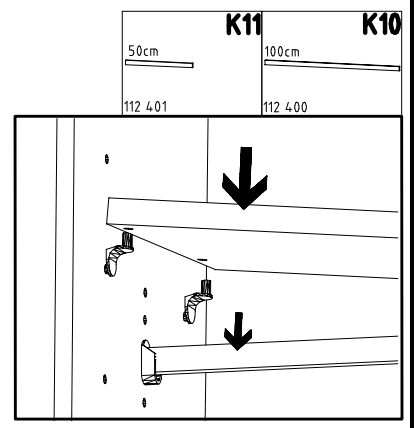
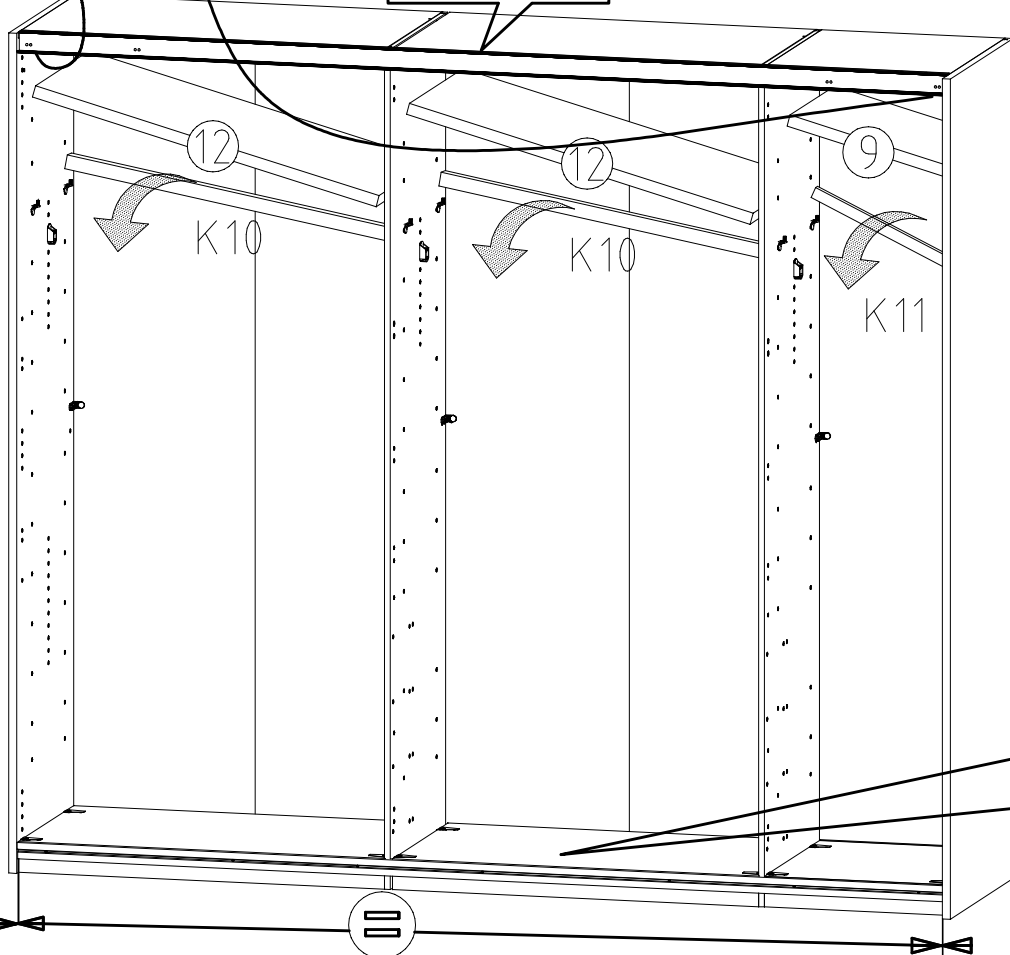

K11 50cm 112 401

K10 100cm 112 400

3,5 x 22 mm **G24**

121 004

FP

1451/1940/2430/2920

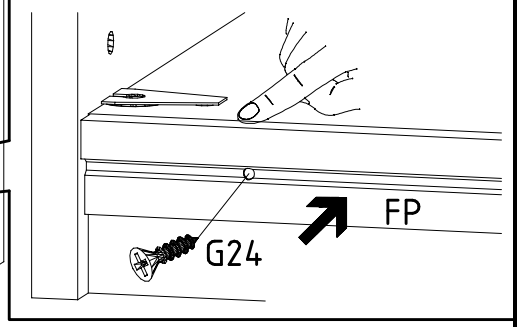

12

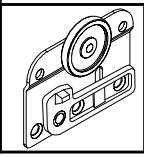
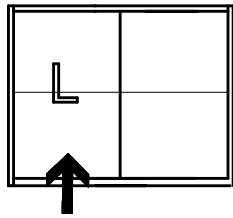
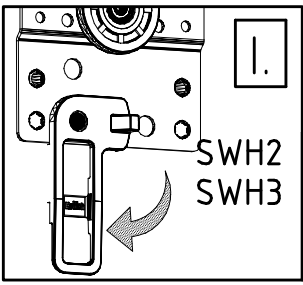

II.

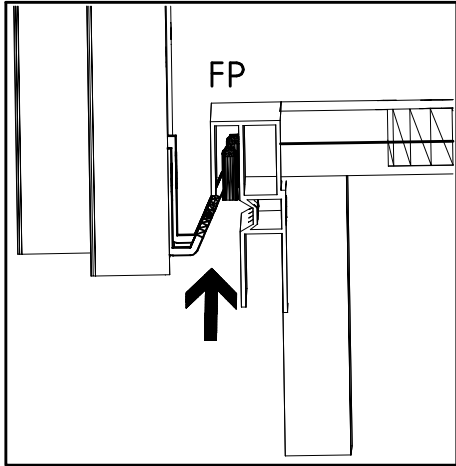

III.

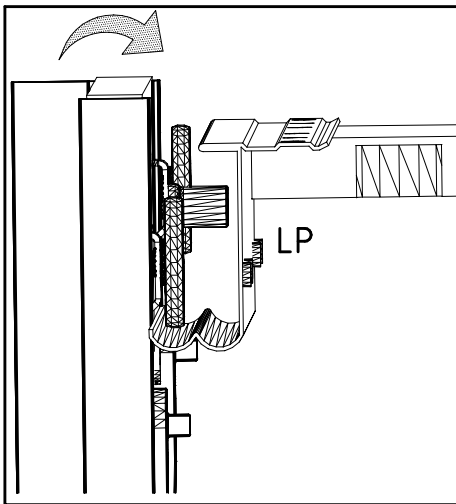

IV.

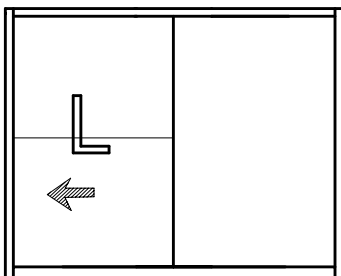
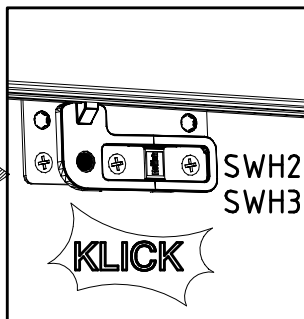
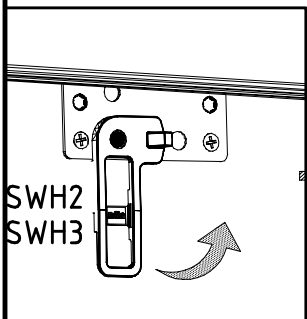

13

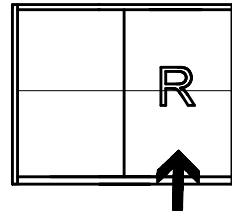

I.

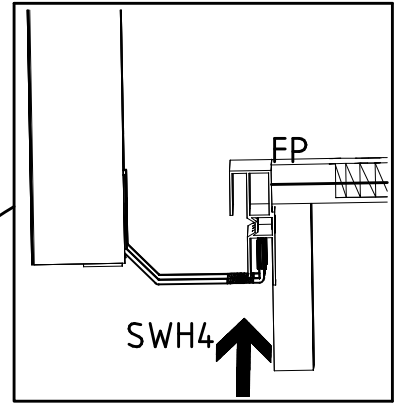
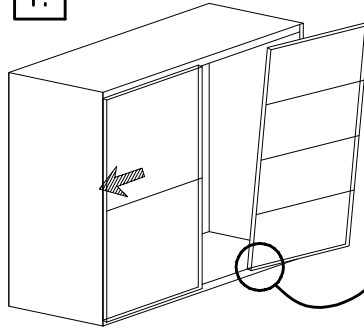

II.

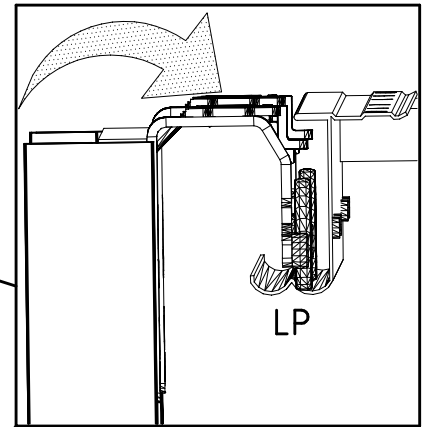
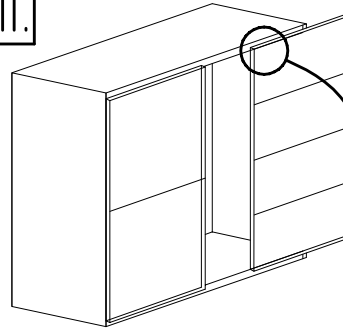

III.

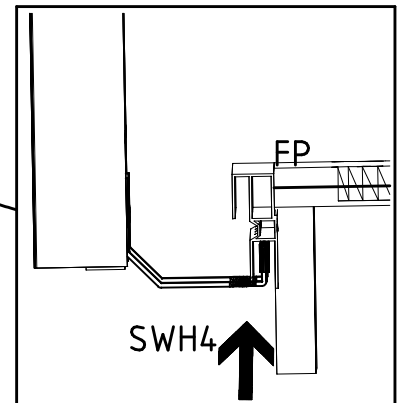
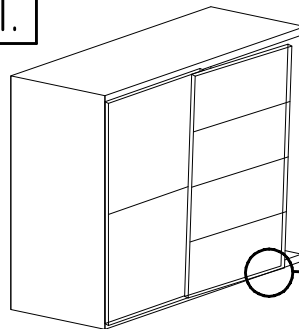

IV.

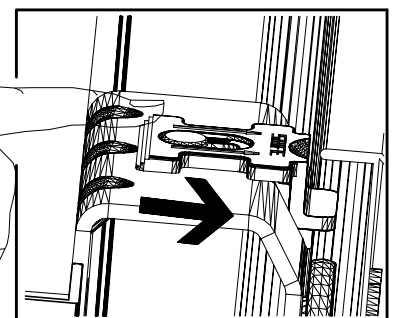
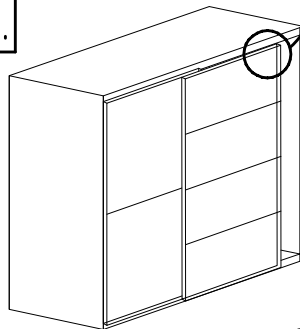

V.

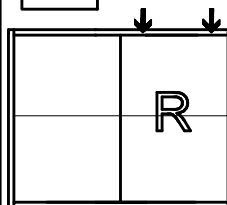

SWH-ST

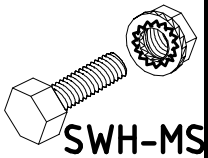
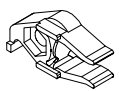

SWH-MS



A

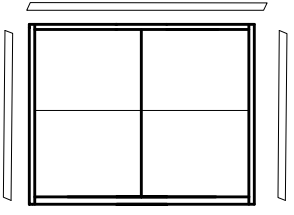

B

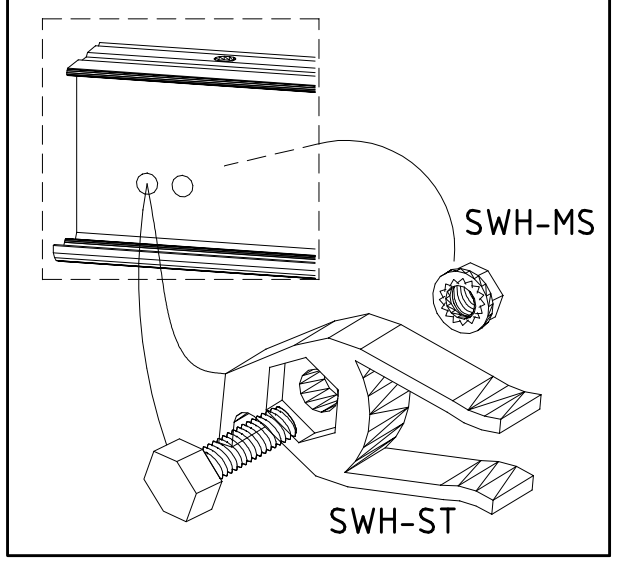
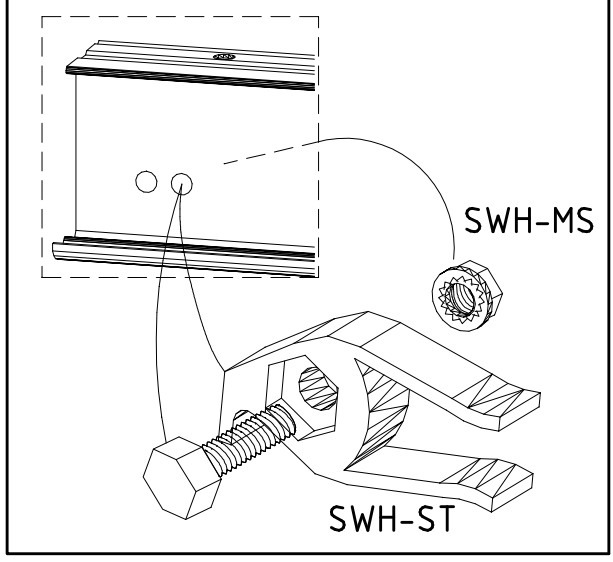
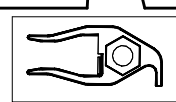
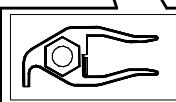
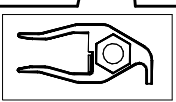
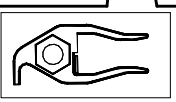
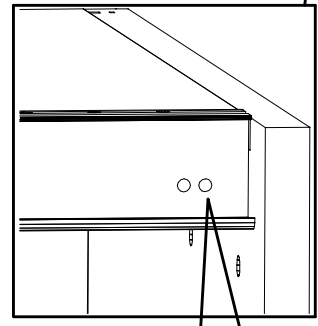
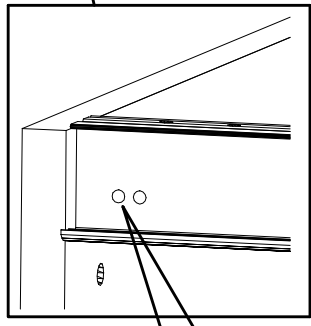
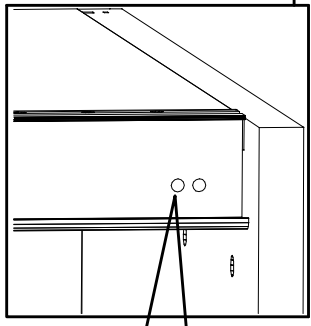
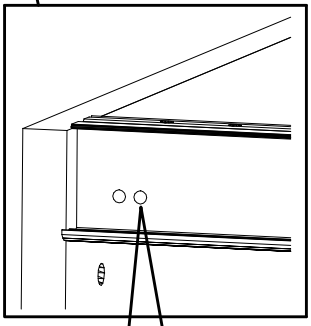
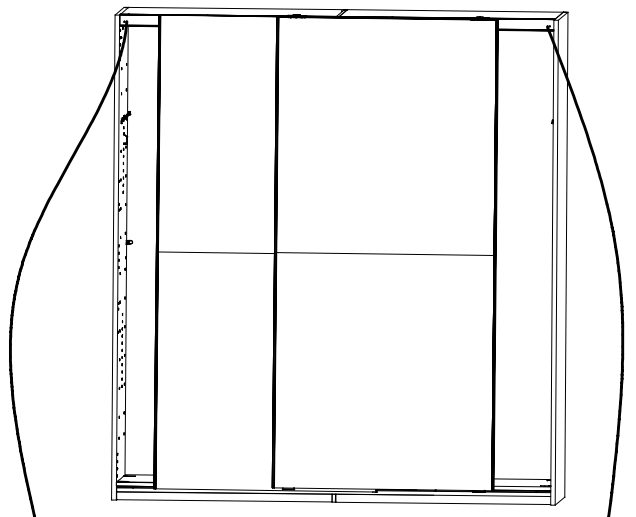
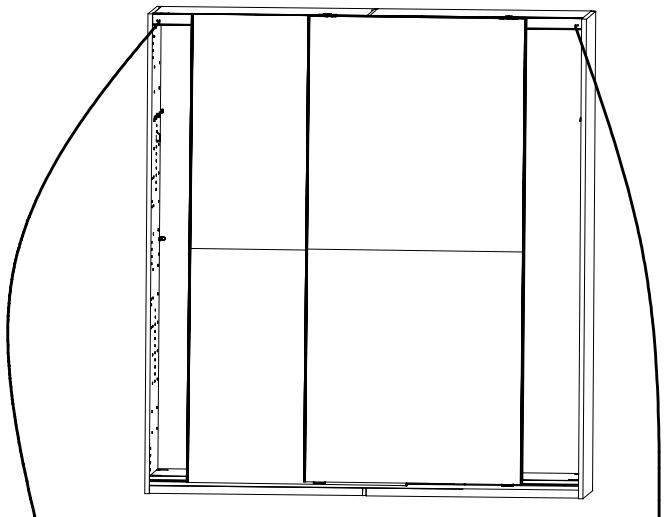
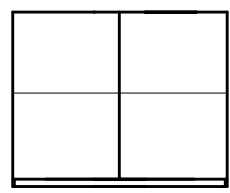

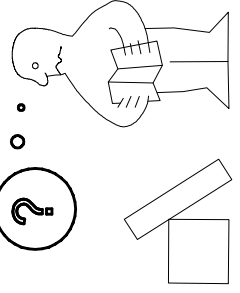
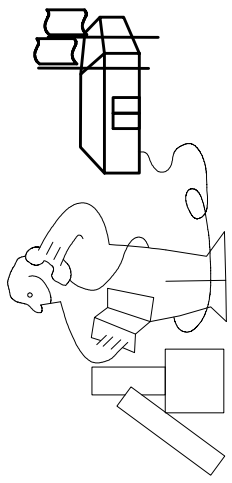
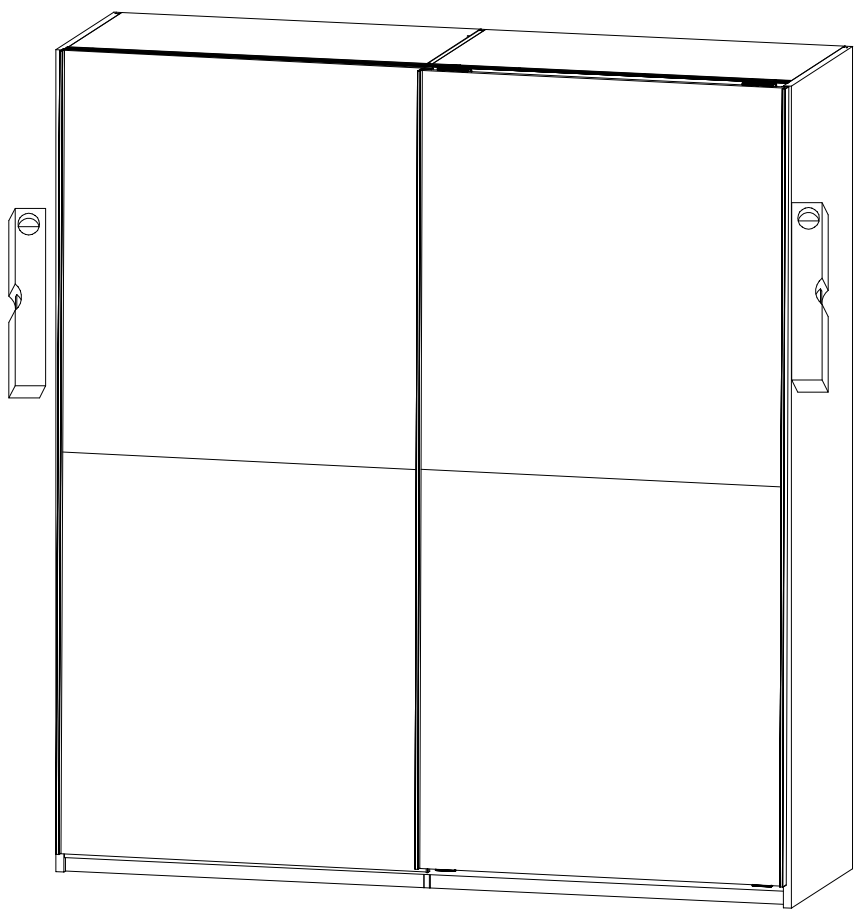
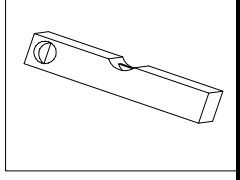

Modell/Model/Modèle

5.

Illustrations of a person using a pencil to mark a cabinet and another person using a pencil to mark a box.

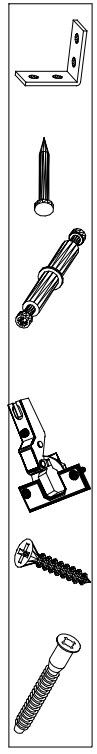

(121 370)	(G 1)	(4x)

Änderungen die dem technischen Fortschritt geschuldet sind, behalten wir uns vor!
 Bei nicht vorschriftsmäßiger und/ oder nicht fachmännischer Montage wird bei Personen- und/ oder Sachschäden keinerlei Haftung übernommen.