

SKIN

Geben Sie hier den
 Modellnamen ein

1116-127-01
 1116-127-45
 1116-127-38

Geben Sie hier die
 Modellnummer ein

127

Geben Sie hier
 den Typ ein

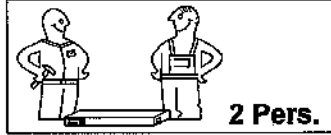

2 Pers.

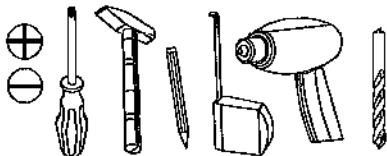
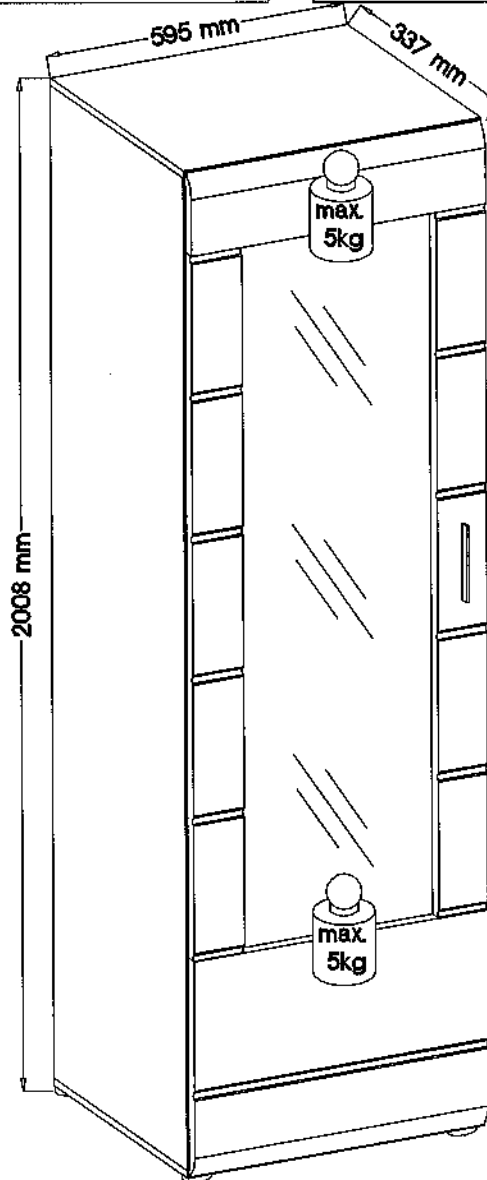
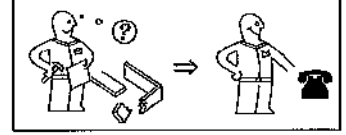
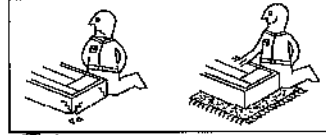

festziehen / tighten / Затягивать / szorít /
 stringere / uláhnuť / vastibreken / zalegnúť /
 strängere / zwięzać / zacięsnąć szorosan /
 meghúzni / pevne doťahnuť / tdnro prilęgniti /
 затянуть / dia át / fajar / Sikk



eindrücken / press in / enfoncer / wcięnąć
 pbeitare / zaščit / Вкараіт / Indrukken
 benyomni / sllaciť / vtlenti / tryck in
 introducere / apăsať / вдавить / tpeñ baetnin



aussenssen / measure / mesurer / mlsurare /
 ormeten / izmeriti / mlaara / kimámi / izmeriti /
 măsurare / измерить / změřit / Измерете / mēt
 upp / zmierzyc / maddir / ölçün



drücken / press / presser / stisknout / Натиснете
 / vtisniť / tashac / drukken / ptišnuť / nacisnac /
 ptišniť / нажать / (meg)nyomni / apăsať / tryck
 fast / nacisnąć / preskonar / Bastinn



einschlagen / hammer in / beverni / ele In frapper au
 marteau / Inforsare / Zabit / zarážiti / Набійте
 / zabit / wbić / Introducere prin bătaie / забить /
 zallouct / clavar / tpeñ vurun



Drahen - wenden / przekreć - odwrócić / Ketten
 - omcraaten / Girare - Ruotara / Oxkenuti - ubrtati
 / Retzumer - renverser / Turn over - turn around /
 Obocite - obratit / Завертете - обвъртете / Obvrtite
 list / Inloareşel - rotiti / Viki tunt - vänd / прокрутить -
 повернуть / otociti - obrátiti / elforgalmi - megfordítani /
 Girar / Çevirin

SKIN

Geben Sie hier den
Modellnamen ein

1116-127-01
1116-127-45
1116-127-38

Geben Sie hier die
Modellnummer ein

127

Geben Sie hier
den Typ ein

D Unser Direktservice für Beschädigte
Sollte Ihnen ein Beschädigtes fehlen, können Sie diese Servicekarte direkt an die entsprechende Adresse mailen. Wir können allerdings nur Beschädigte auf diesem Wege verechnen. Sollten Sie eine andere Beanstandung an Ihrem Möbelstück haben, so wenden Sie sich bitte direkt an Ihr Möbelhaus.

GB Our direct contact service for fitting
If a fitting part is missing, you can e-mail this service card directly to the address below. However, we can only send fitting parts in this way. If you have any other cause for complaint concerning your item of furniture, please contact your furniture store directly.

CZ Naša přímá služba pro kování
Chybí-li vám nějaký díl z kování, můžete tuto servisní kartu odeslat e-mailem přímo na níže uvedenou adresu. Tímto cestou však můžeme rozšířit jen díly kování. Pokud byste reklamovali jiné díly nábytku, obraťte se přímo na svého prodejce nábytku.

F Bien choisir la notice de montage
Si vous manquez une ferrure, veuillez envoyer directement la présente carte service à l'adresse e-mail indiquée ci-dessous. Cependant, ceid nous permet uniquement d'envoyer des ferrures. Pour tout autre type de réclamation concernant votre meuble, veuillez contacter directement votre magasin d'ameublement.

I Il nostro servizio clienti per il ordine della ferramenta
Qualora Vi dovesse mancare un pezzo di fissaggio, allora Vi preghiamo di inviare questa carta di servizio immediatamente all'indirizzo sottostante. Possiamo inviare i pezzi di fissaggio solamente per mezzo di questo procedimento. Qualora dovesse avere qualche altra reclamazione in merito al mobile, allora Vi preghiamo di rivolgerVi direttamente al Vostro Negozio di mobili.

BG Където липовата карта за обнова
Ако липовата карта за обнова липовата сервисна карта и тя я изпратете на e-mail адреса, посочен по-долу. По този начин можем да доставяме само липовите елементи от обнова. Ако установите други дефекти по мебелите, Ви съветваме да се обвържете към мебелната къща/магазин, от който сте закупили стоката.

NL Onze directservice voor beschadigden
Wanneer er een onderdeel ontbreekt, kunt u deze servicekaart direct aan ons adres e-mailen. Wij kunnen langzamerhand deze weg echter alleen besloten vaststellen. Mocht u een ander probleem aan uw meubel hebben, verzocht wij u contact op te nemen met uw meubeldealer.

PL Nasza bezpośrednia usługa dla uszkodzonych
Jeżeli brakuje części konstrukcyjnych do montażu, prosimy o przesłanie nam niniejszej karty serwisowej na niżej podany adres e-mailowy. W ten sposób możemy przesłać jedynie elementy konstrukcyjne. W przypadku innych reklamacji dotyczących mebli, prosimy zgłosić się do salonu meblowego, w którym został dokonany zakup.

HR Servis za okovje
U slučaju da nedostaje neki od dijelova molimo vas da na dole navedenu mail adresu pošaljete ovaj servisni obrazac. Na ovaj način mogu se dostaviti samo okovje. U slučaju da imate dodatne prigovore vezane uz komad namještaja molimo vas da se obratite direktno trgovini namještaja gdje je isti kupljen.

HU Direkt szolgáltatunk vevényekhez esetén
Ha hiányzik egy részlet, ezt e-ként küldve eljuttathatjuk az alább található címre. Azonban csak a vevényekhez tudunk így közeledni. Amennyiben másfajta reklamáció áll fenn birtoklásjal kapcsolatban, forduljon közvetlenül a boltiáruházhoz.

SK Naše priamy servis pre časti kování
Ak ty Vám chýba niekedy niekedy časť kování, môžete poslať túto servisnú kartu priamo e-mailom na nižšie uvedenú adresu. Týmto spôsobom môžeme poslať iba kování. Ak by ste mali inú reklamáciu týkajúcu sa nábytku, obráťte sa priamo na Vašu predajňu nábytku.

SLO Naše direktna usluga storitve za okovje
Če vam manjka kakšno okovje, lahko to servisno kartico pošljete po e-pošti direktno na spodnji naslov. Po tej poti vam lahko pošljemo samo okovje. Če želite reklamirati kakšen drug del pohištva, se obrnite neposredno na vaše trgovino pohištva.

RO Serviciu în nostru direct pentru feronerie
In cazul în care vă lipsesc o piesă de feronerie puteți să trimiteți direct acest card de service prin e-mail la adresa de mai jos. Noi nu putem expedia parte de feronerie decât pe această cale. Dacă aveți o altă reclamație referitoare la piese de mobilier, atunci vă rugăm să vă adresați direct la magazinul dvs. de mobilier.

RUS Наш прямой сервис для поставки фурнитуры
Если окажется, что Вам не хватает того или иного элемента фурнитуры, мы можем отправить сервисную карту по факсу непосредственно на некорректный адрес электронной почты. Однако, таким образом мы можем пересылать лишь фурнитуру. Если же у Вас возникнут иные претензии относительно приобретенной мебели, пожалуйста, обращайтесь непосредственно в организацию, осуществляющую продажу.

S Vår direkta tjänsten för beskadigade
Om du saknar en beslagdel kan du skicka detta servicekort direkt till e-postadressen som anges nedan. Tänk på att detta är den enda möjligheten att skicka beslagdelar till dig. Om du vill reklamera din möbel av en annan orsaking måste du kontakta ditt möbelhus direkt.

ES Nuestro servicio directo para accesorios
Si le falta algún accesorio, puede enviar esta tarjeta de servicio directamente a la siguiente dirección. No obstante, por este método solo podemos enviar accesorios. Si tiene alguna otra objeción sobre su mueble, consulte directamente con su mueblería.

TR Donatılar için doğrudan servisini
Bir donatınız eksikse bu servis kartını doğrudan aşağıda bulunan adrese doğrudan mail yazabilirsiniz. Sadece bu yolla donatılar gönderilebilir. Mobilyanızda başka şikayetleriniz varsa lütfen doğrudan mobilya satıcınıza danışın.

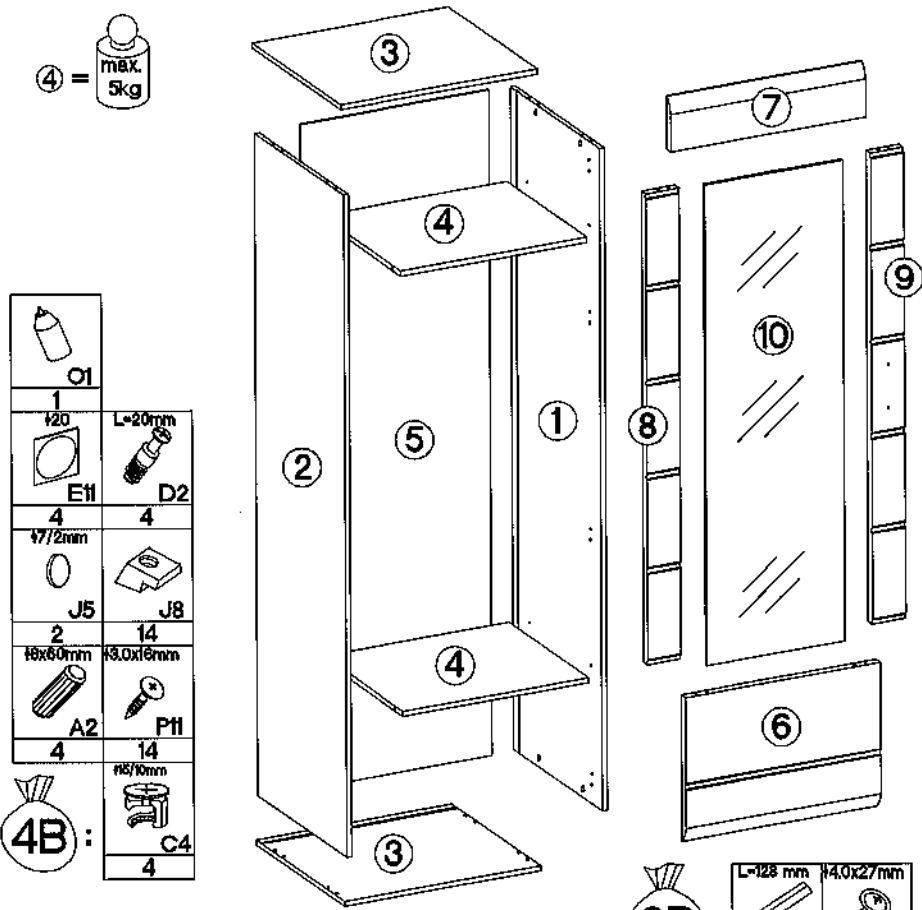

Grund der Beanstandung / Reason of the objection:

Möbelhaus / Furniture store:

Nome / Name: _____ Telefon / Telephone: _____

PLZ / postal code: _____ Ort / City: _____

Strasse / Street: _____

Haus-Nr. / House No.: _____ @E-Mail: _____

LKZ 80106

1

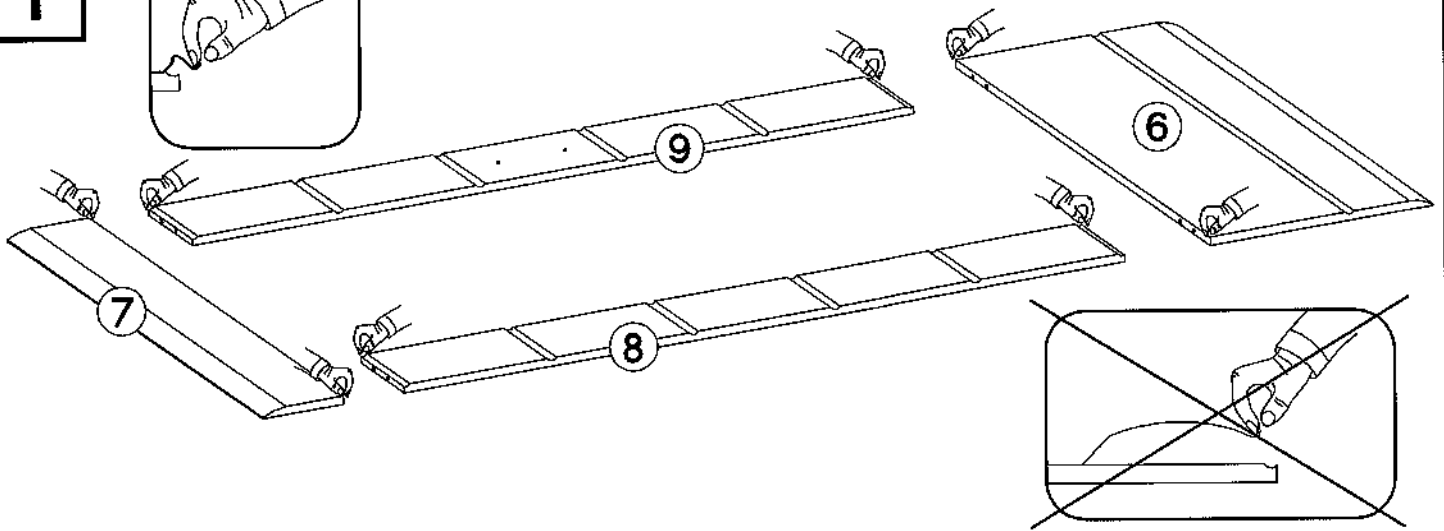
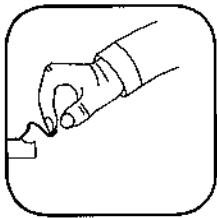

2

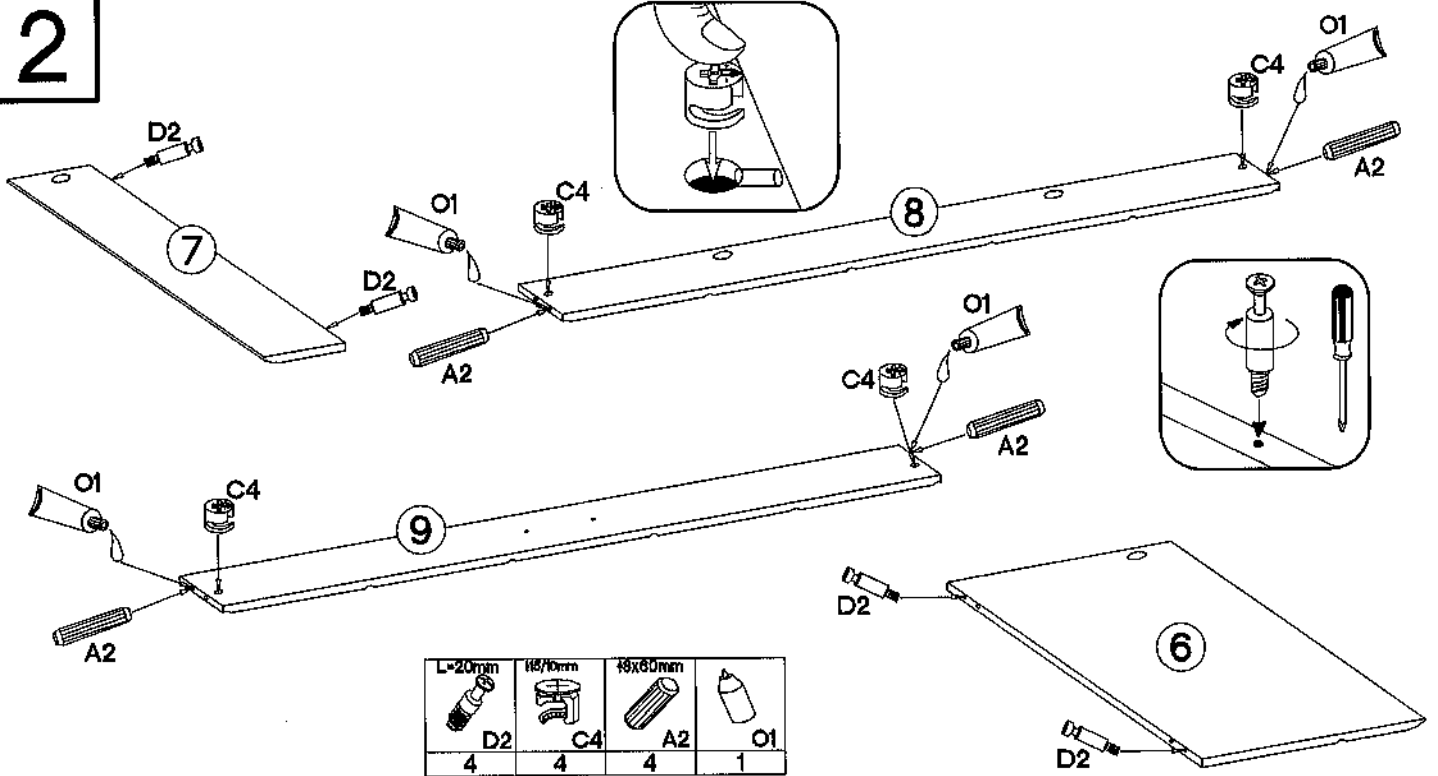
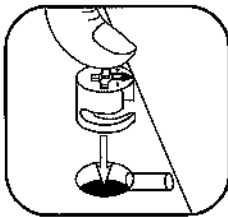



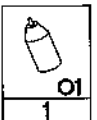
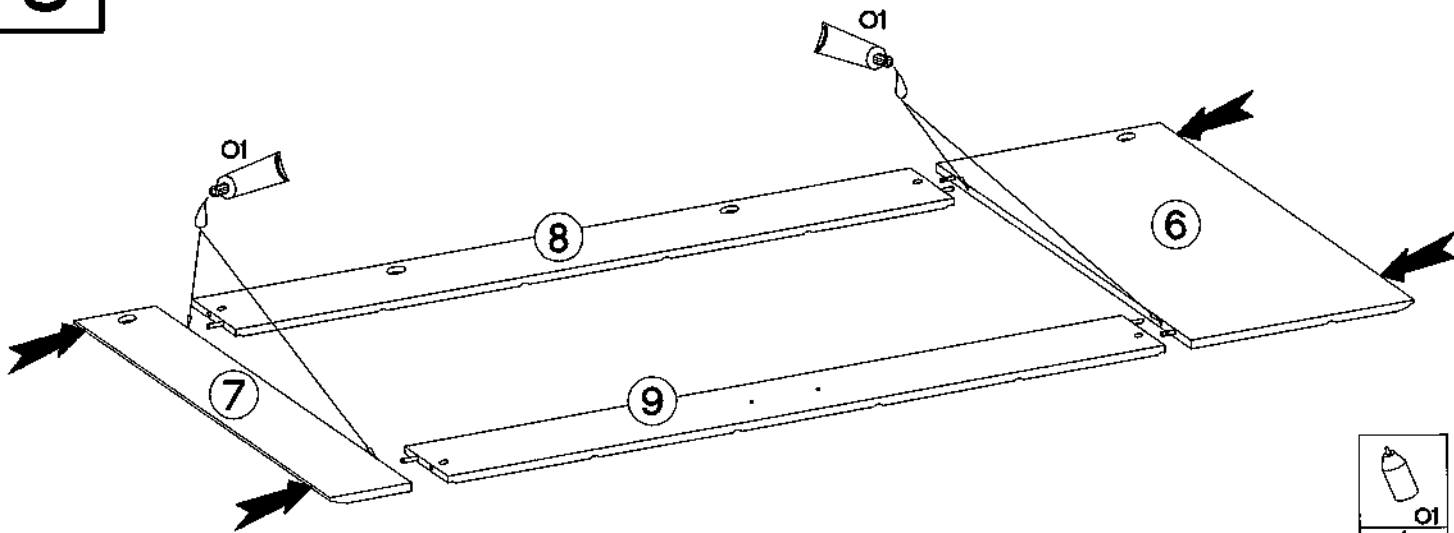

4	4	4	4	1

3



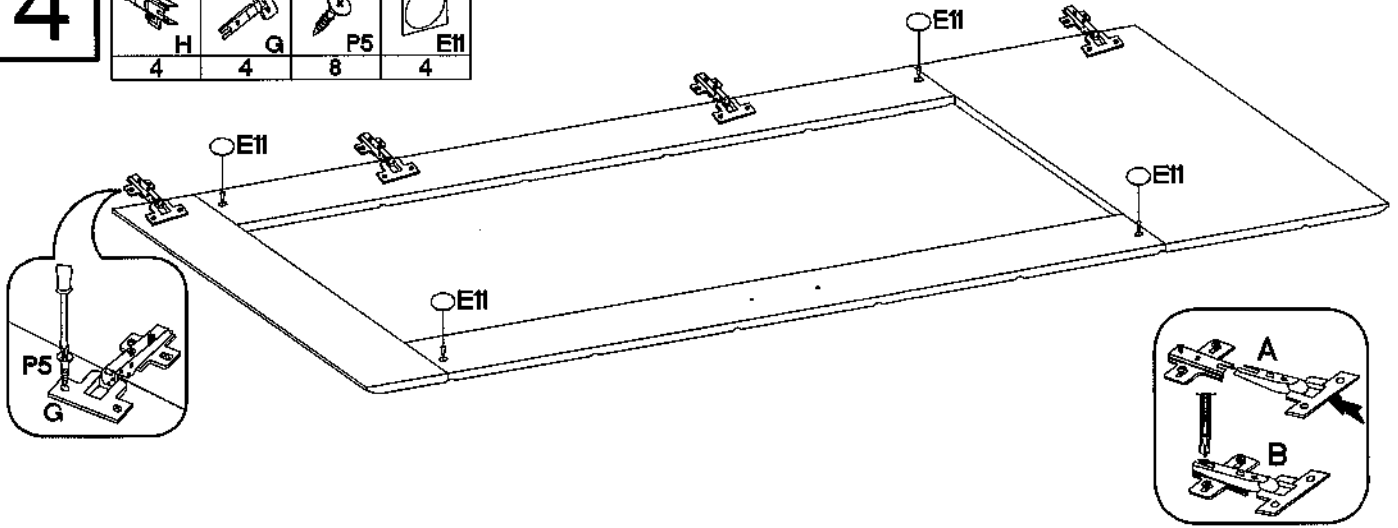

4

			
4	4	8	4







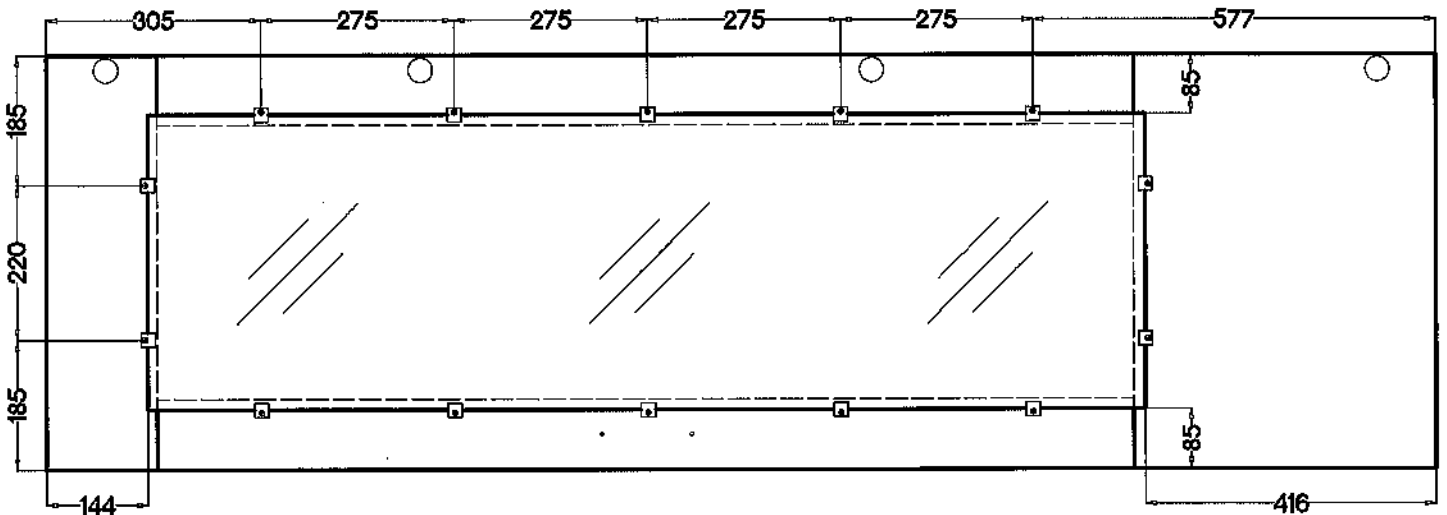
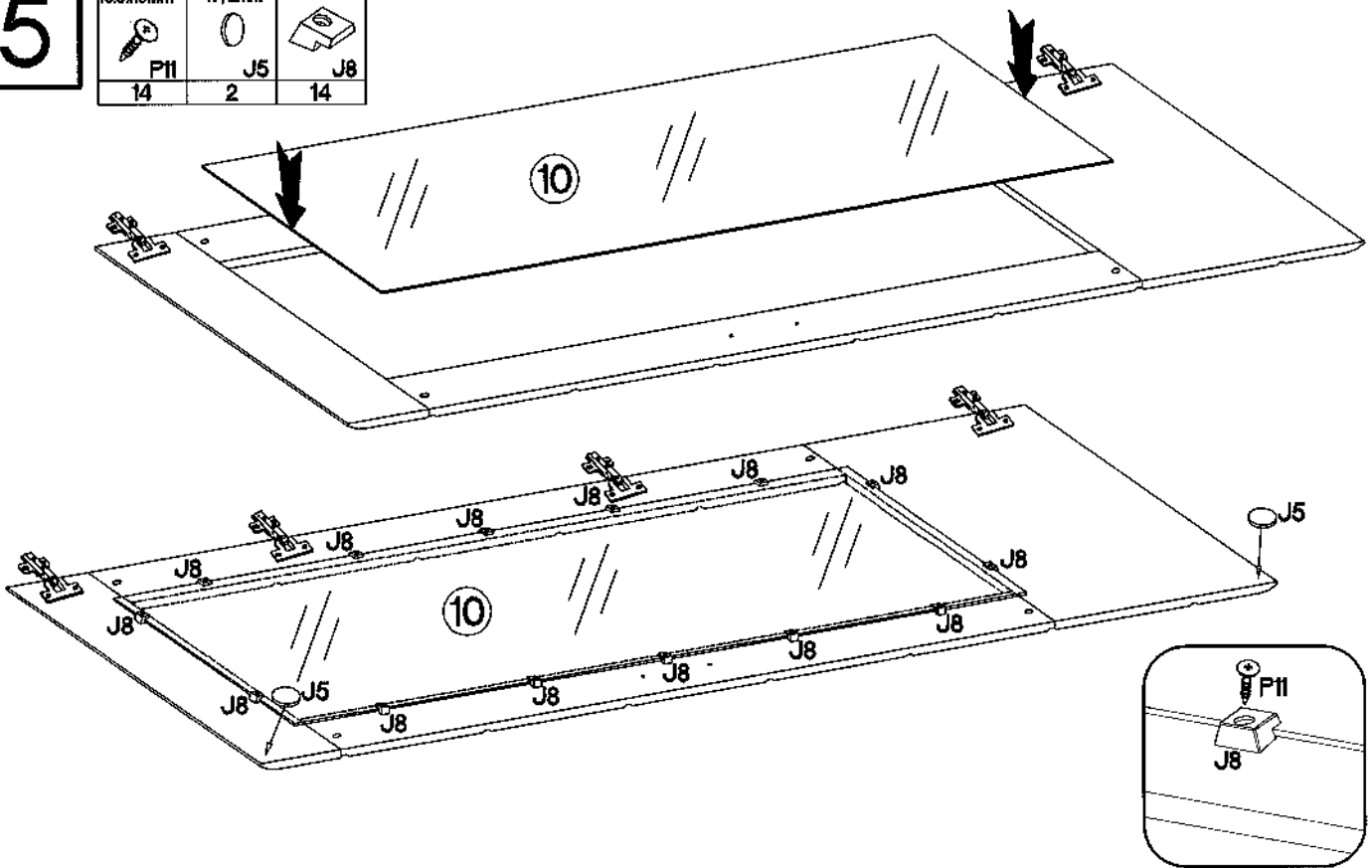

5

		
14	2	14



6

						
8 A	16 D2	16 C	4 P14	4 F10	1 K19	4 P11

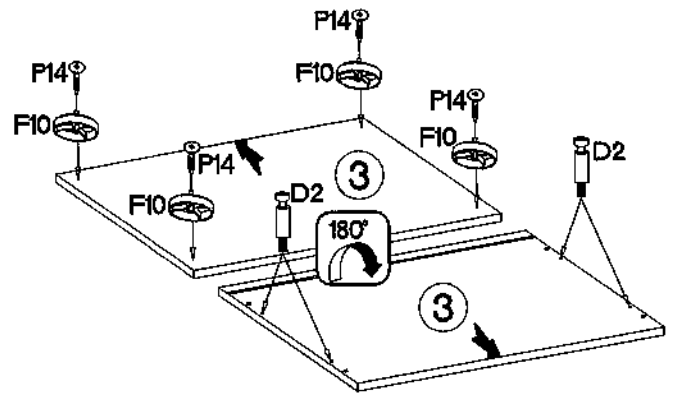
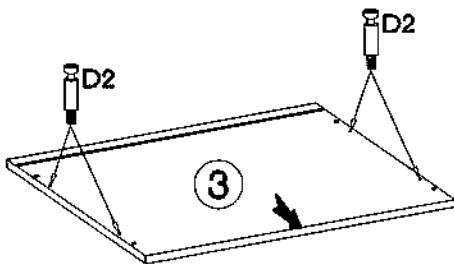
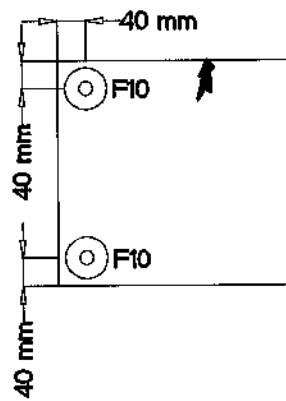
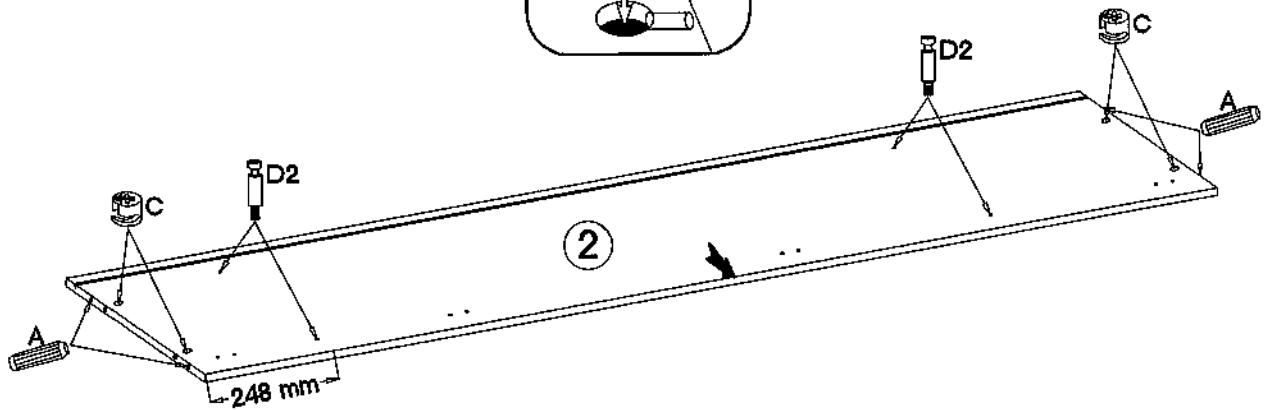
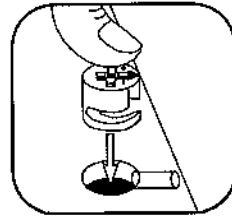
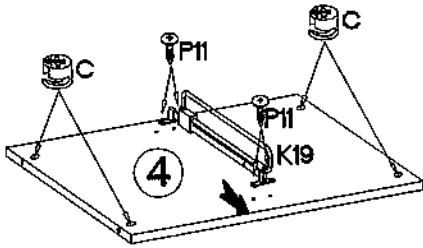
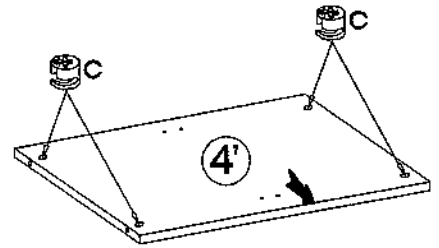
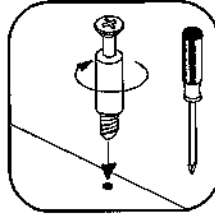
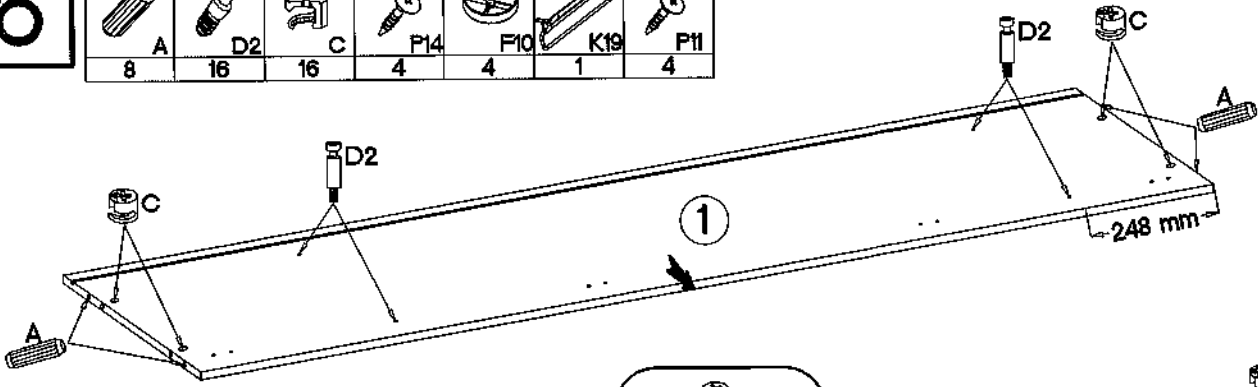

7

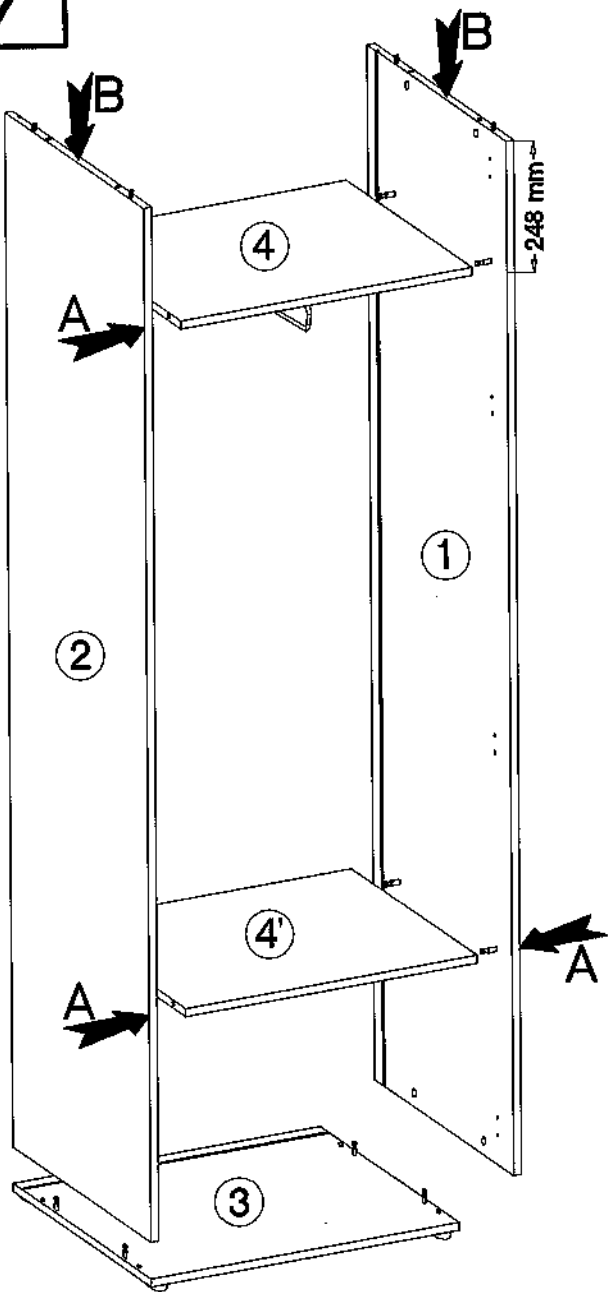

8

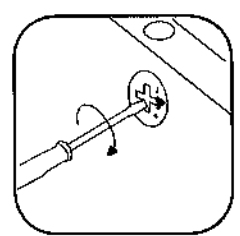
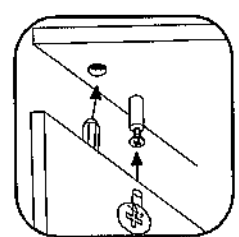
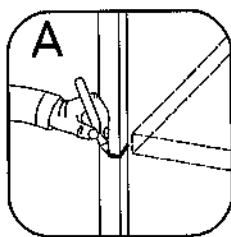
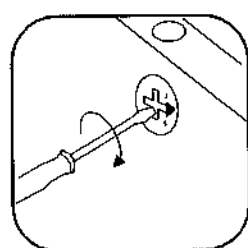
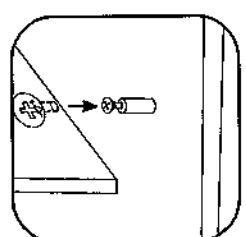
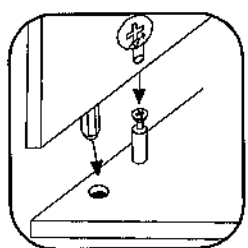
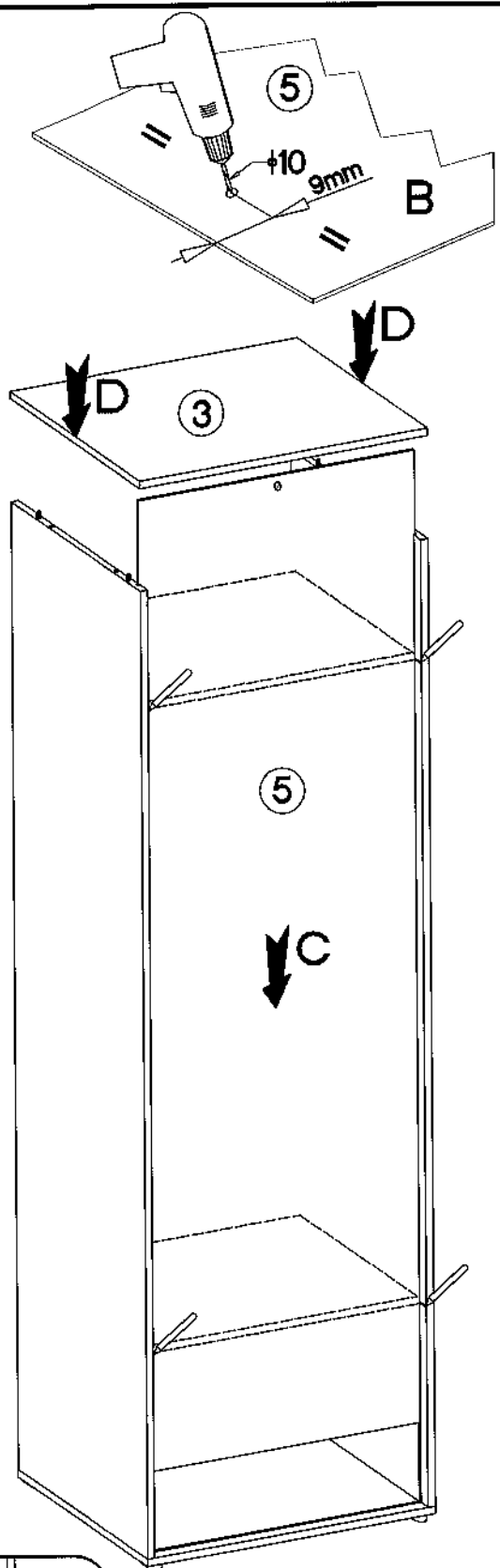

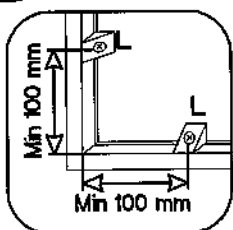
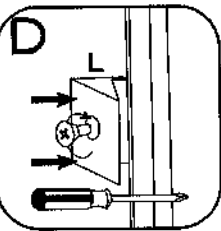
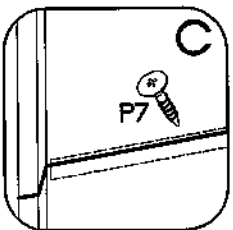
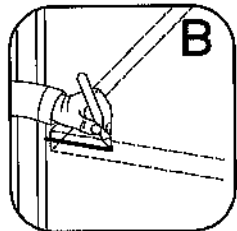
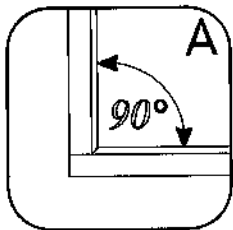
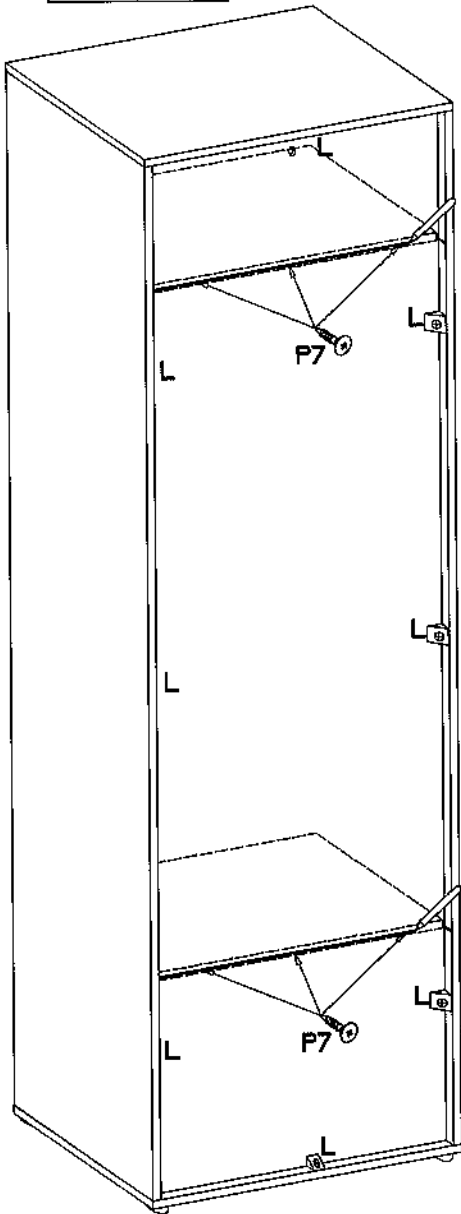

9

	13.0x20mm
L	P7
8	6



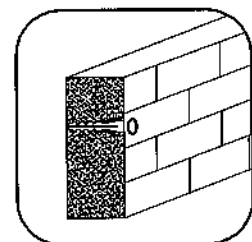
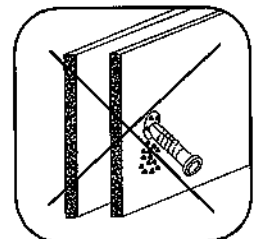
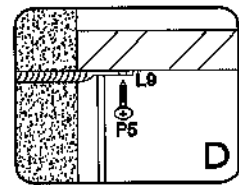
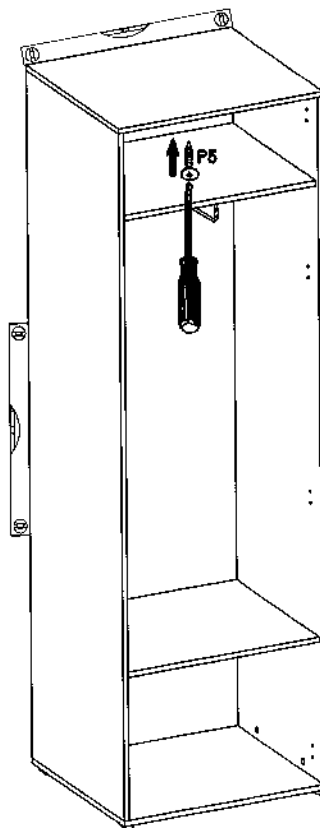
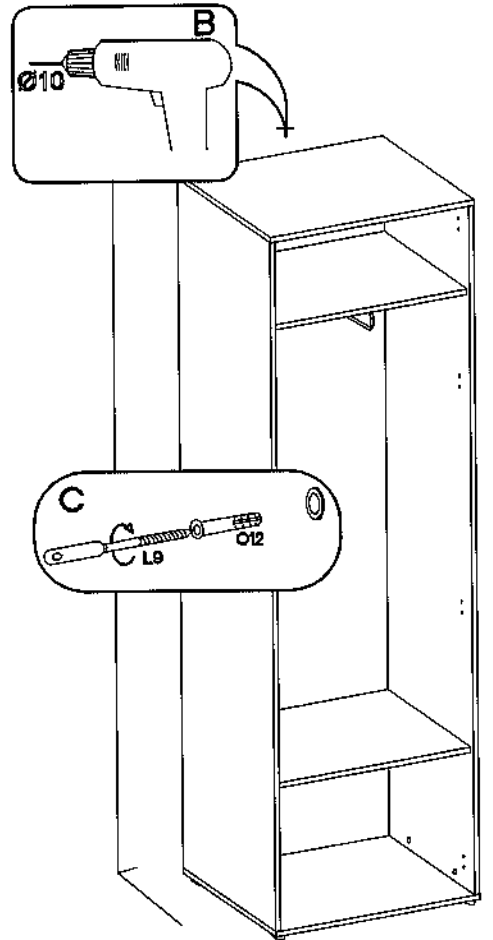
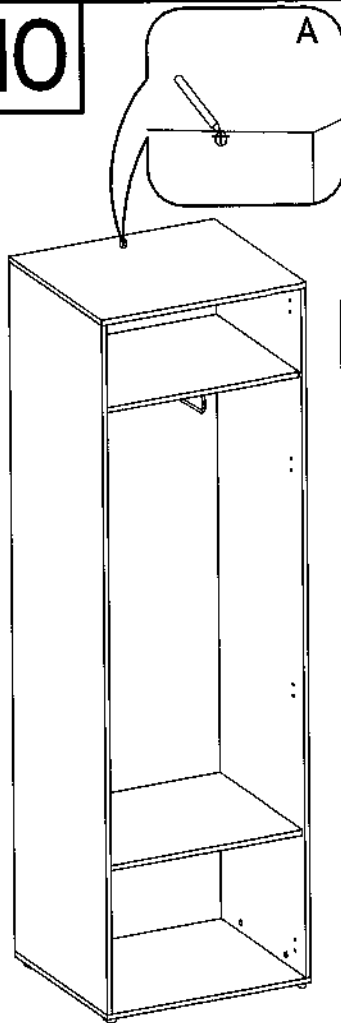

10

		
16x50mm	L9	13.5x13mm
O12	L9	P5
1	1	1



11

		
E	S2	R1
16	1	2

