

NANO

5

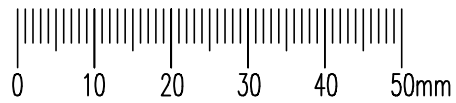

400 450

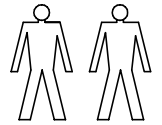
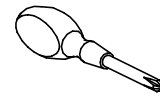
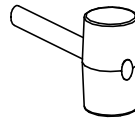
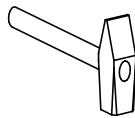
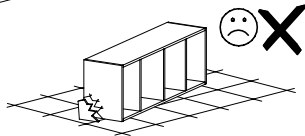
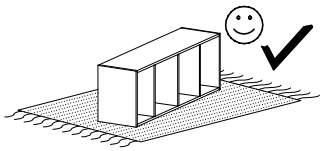
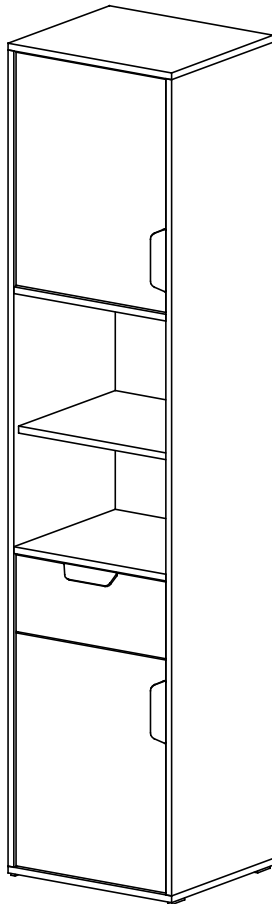

1950

450 400

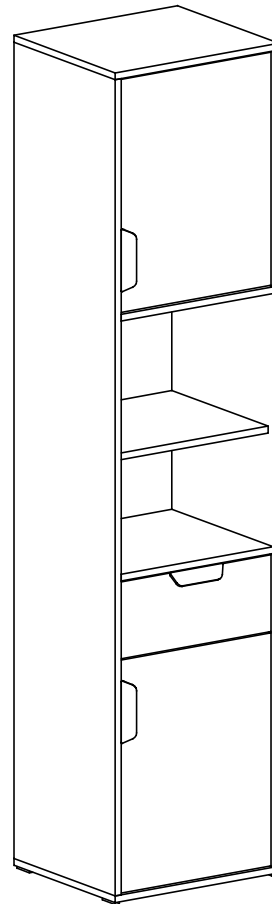

1950

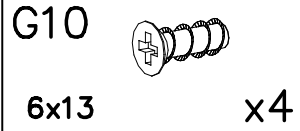
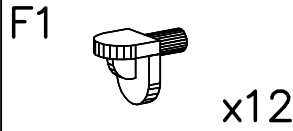
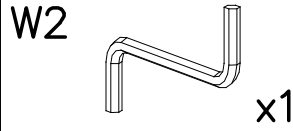
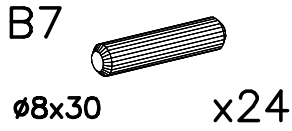
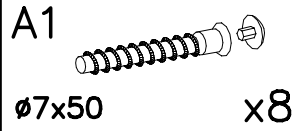
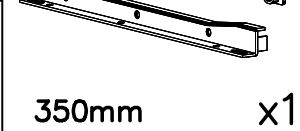
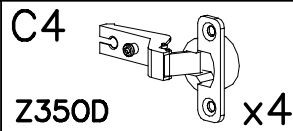
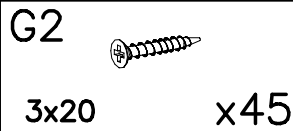
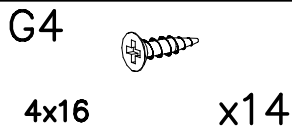
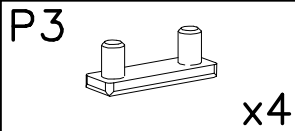
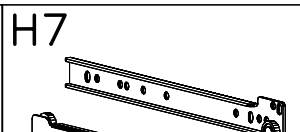
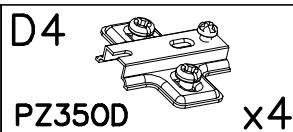
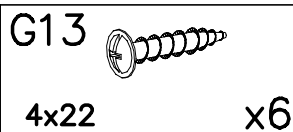
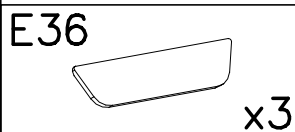

1

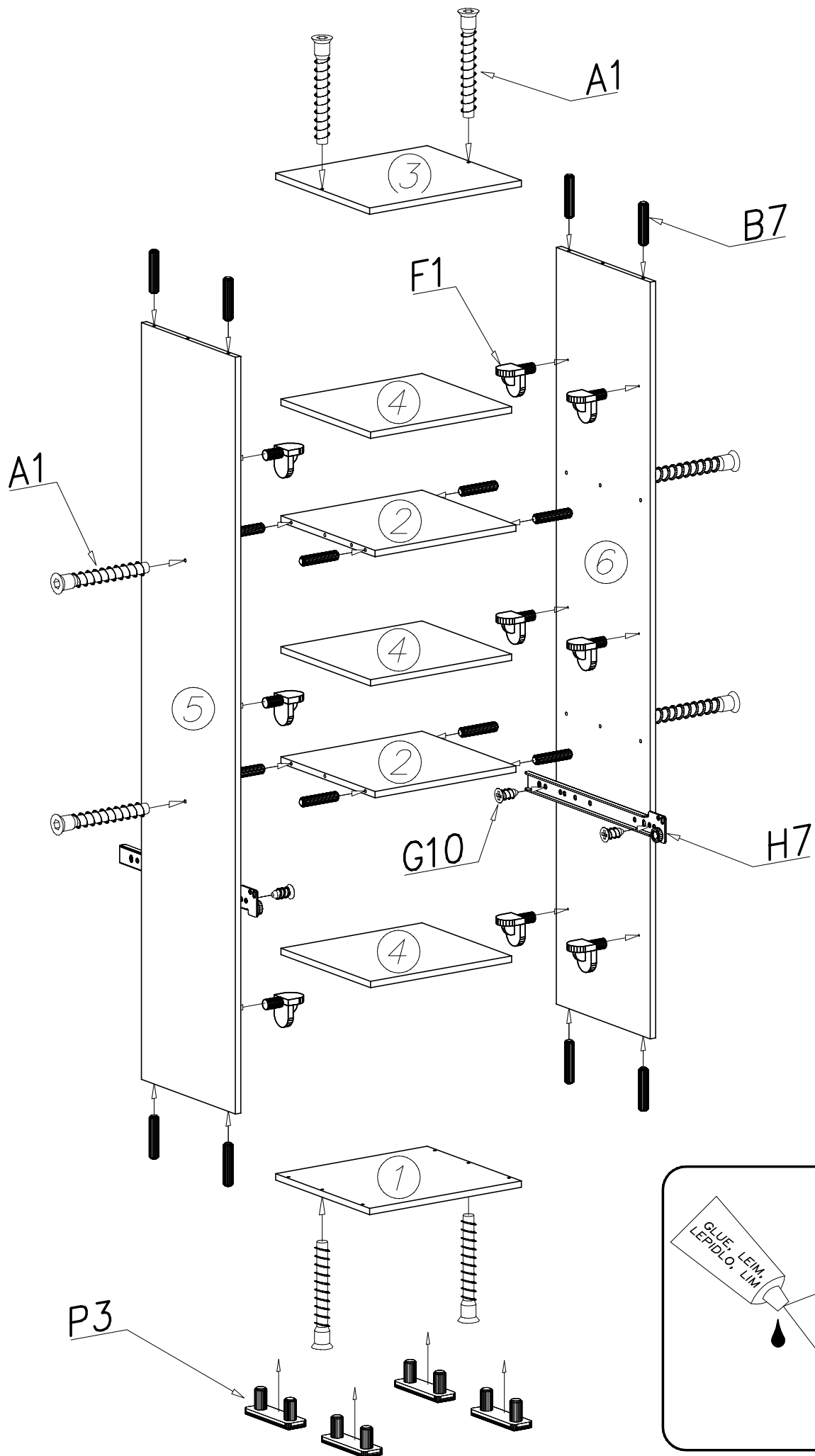

II

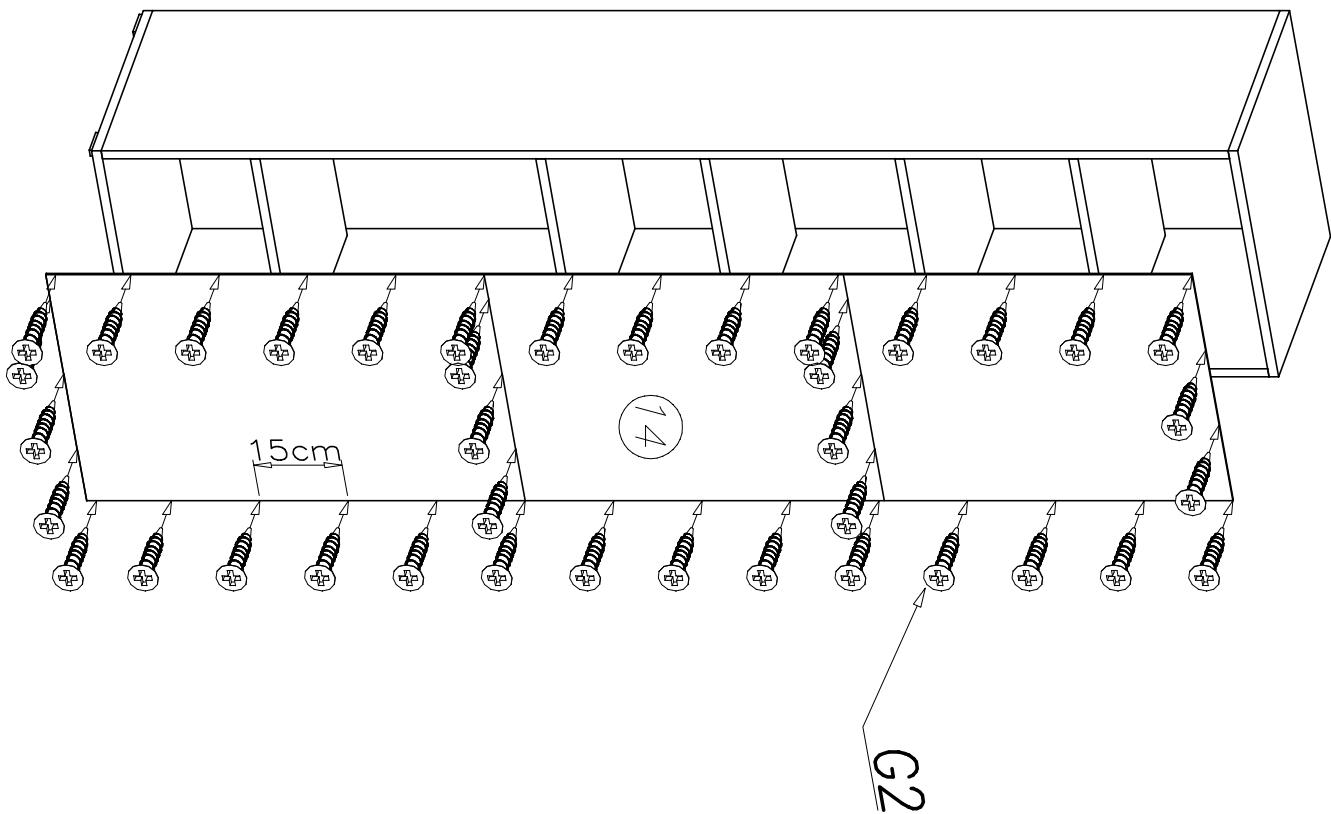

III

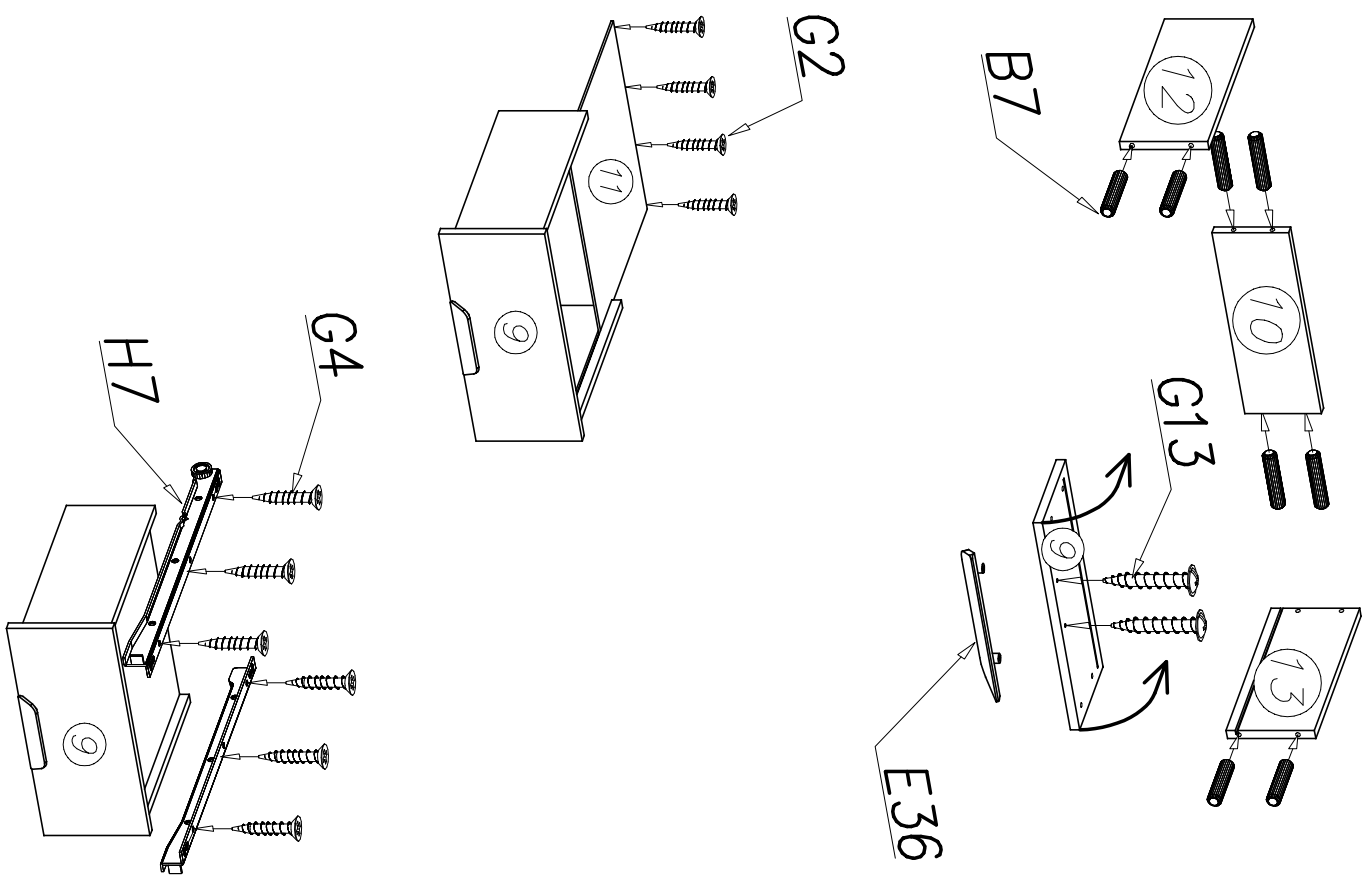

IV

