

<http://www.bega-gruppe.de>

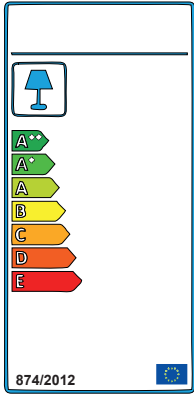

BG	Bulgarisch	български
CS	Tschechisch	čeština
DA	Dänisch	Dansk
DE	Deutsch	Deutsch
ET	Estonisch	Eesti
EL	Griechisch	ελληνικά
EN	Englisch	English
ES	Spanisch	español
FR	Französisch	Français
FI	Finnisch	suomalainen
HR	Kroatisch	hrvatski
HU	Ungarisch	magyar
IT	Italienisch	Italiano
LV	Lettisch	Latvijas
LT	Litauisch	Lietuvos
NL	Niederländisch	Nederlands
PL	Polnisch	Polski
PT	Portugiesisch	português
RO	Rumänisch	român
SK	Slowakisch	slovenský
SL	Slowenisch	slovenščina
SV	Schwedisch	Svenska

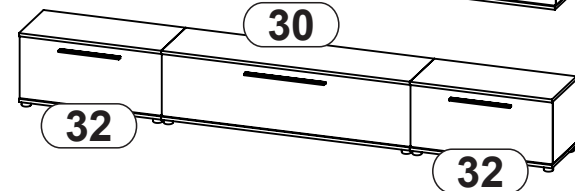

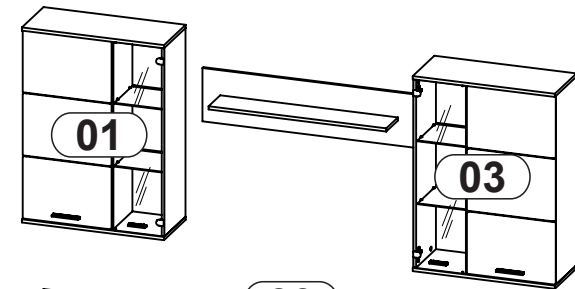
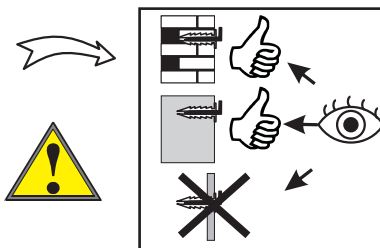
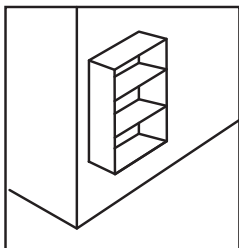
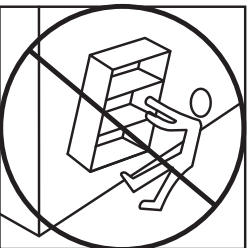
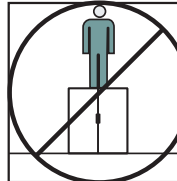
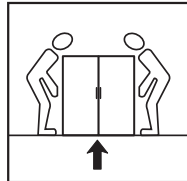
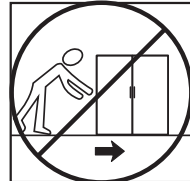
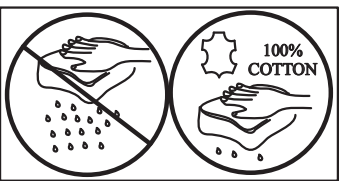
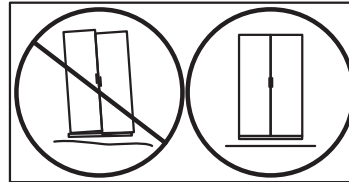
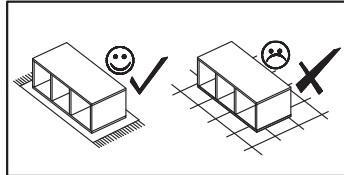
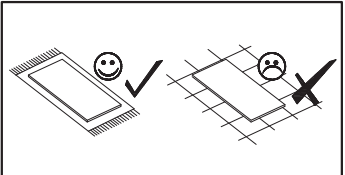
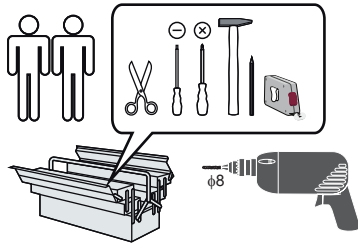
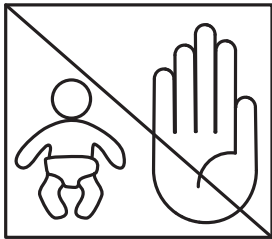
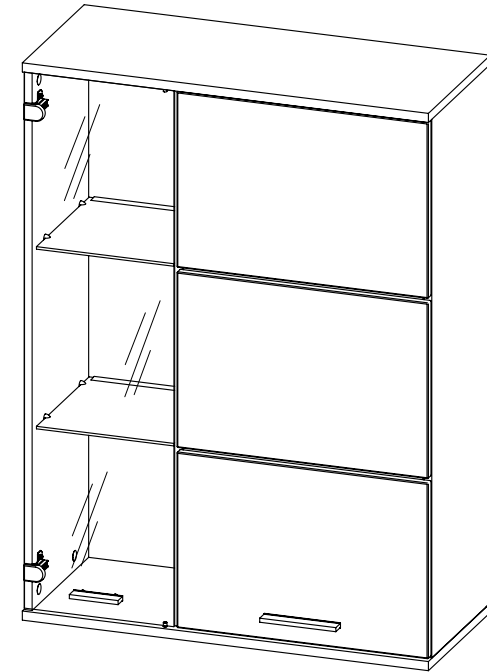
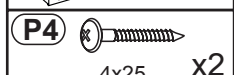
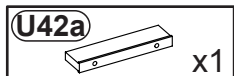
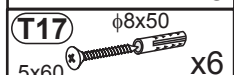
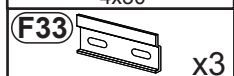
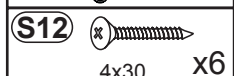
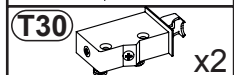
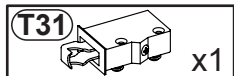
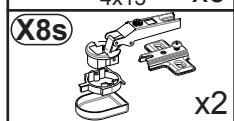
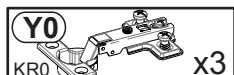
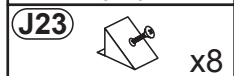
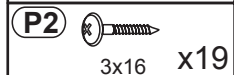
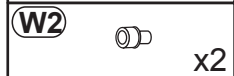
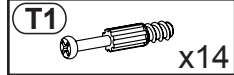
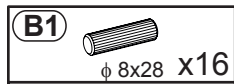

Nr	Ausmaß			St
1	471	285	5	2
2	271	285	5	2
3	1056	295	4	1
4	1062	326	15	1
5	1062	314	15	1
6	1062	294	15	1
7	768	100	15	1
8	800	335	18	1
9	800	335	18	1
10	346	495	16	1
11	346	495	16	1
12	346	495	16	1
13	472	70	4	2
14	1076	291	2	1
15	1076	490	2	1

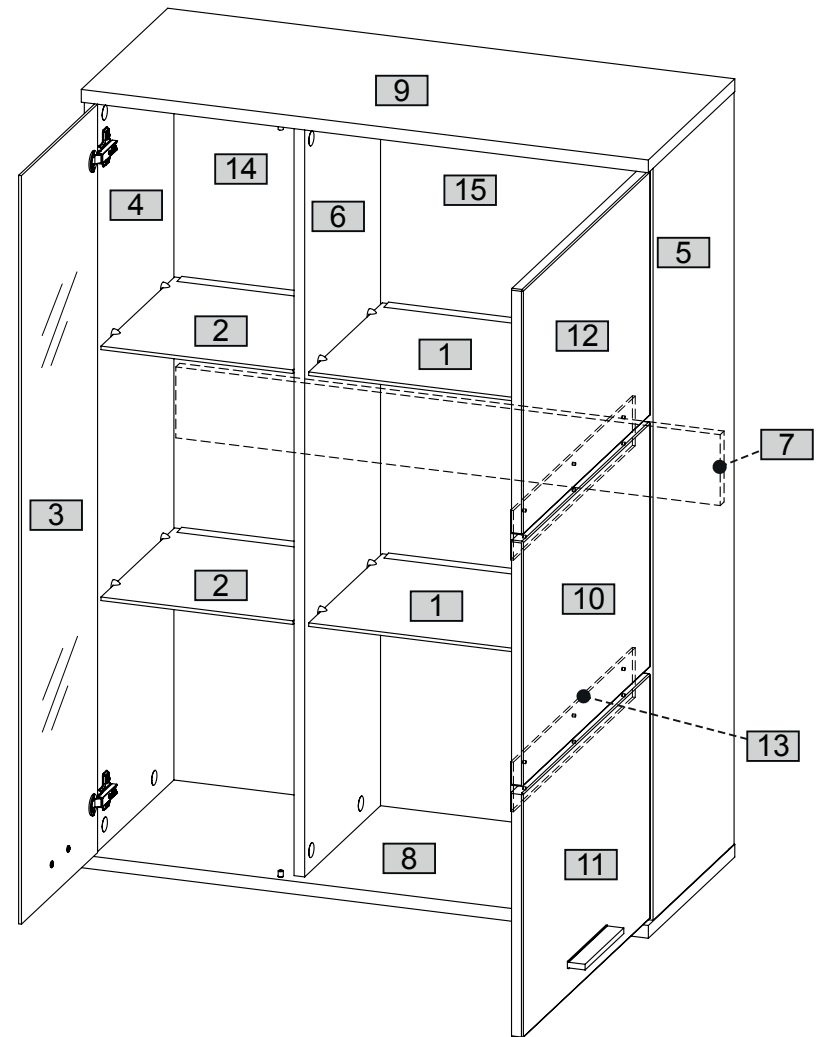

1

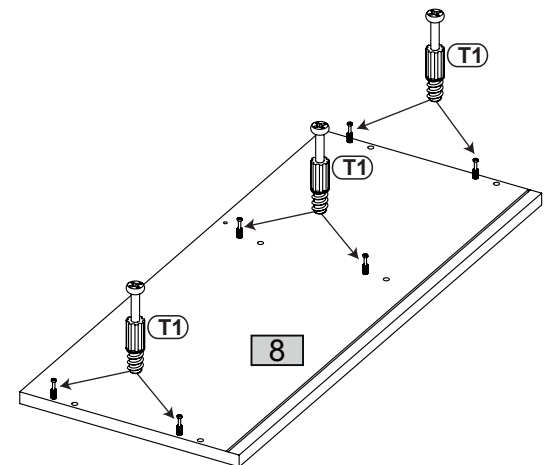
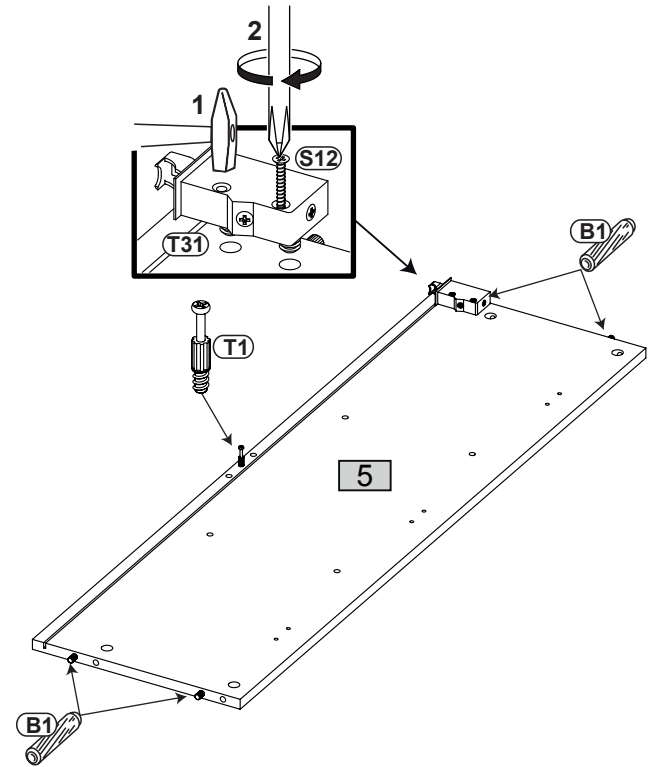
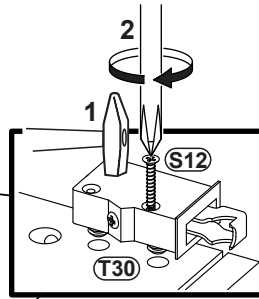
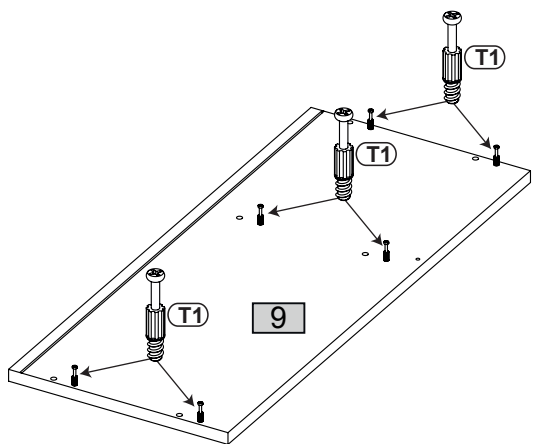
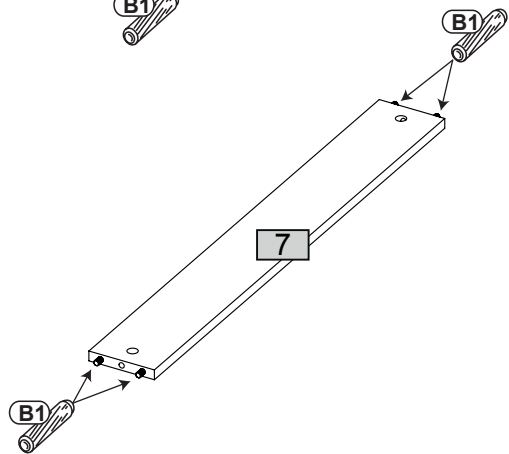
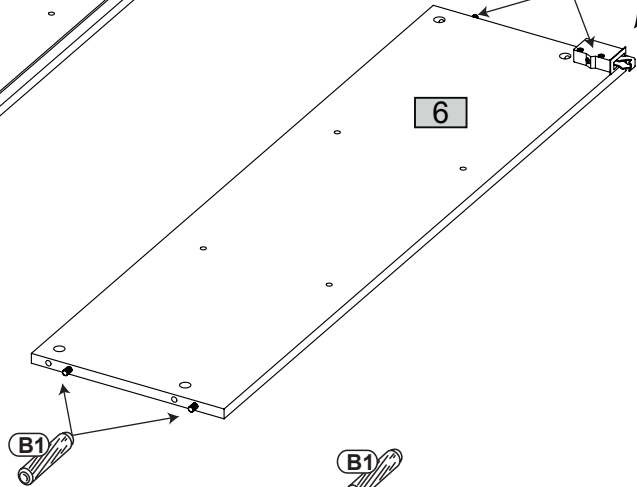
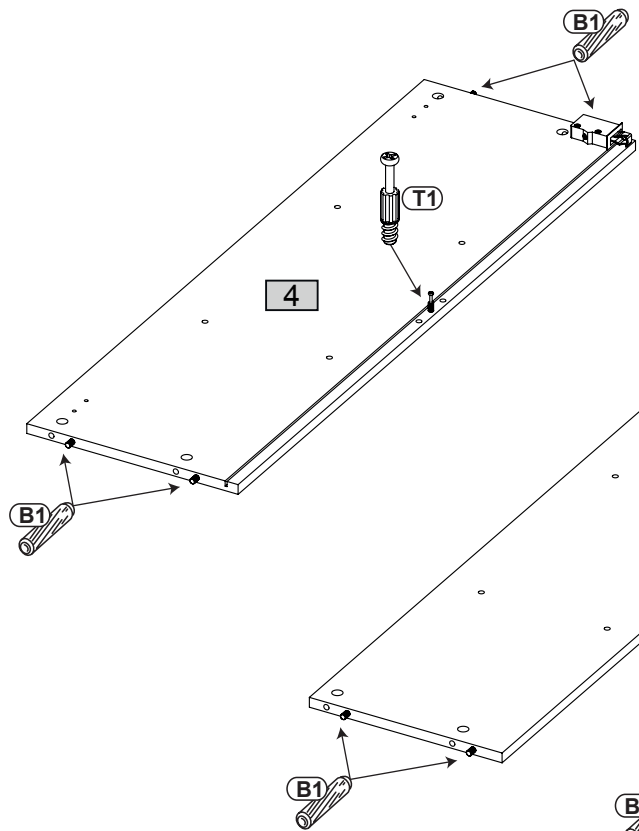
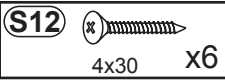
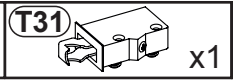
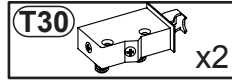
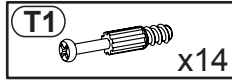
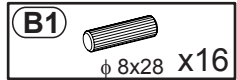

2

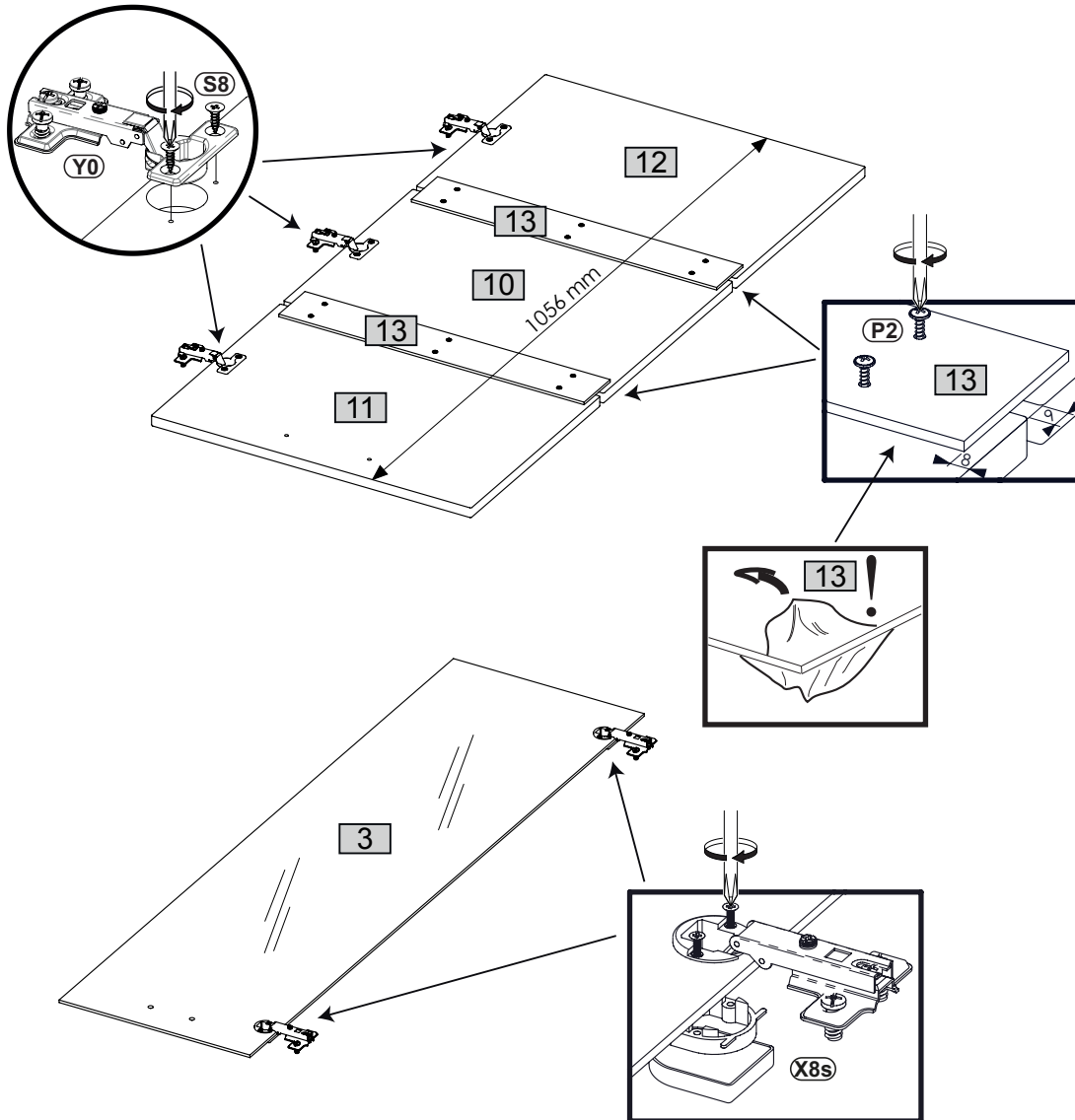
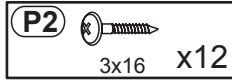
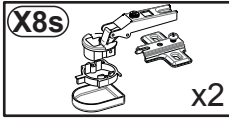
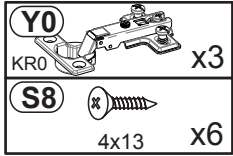

3

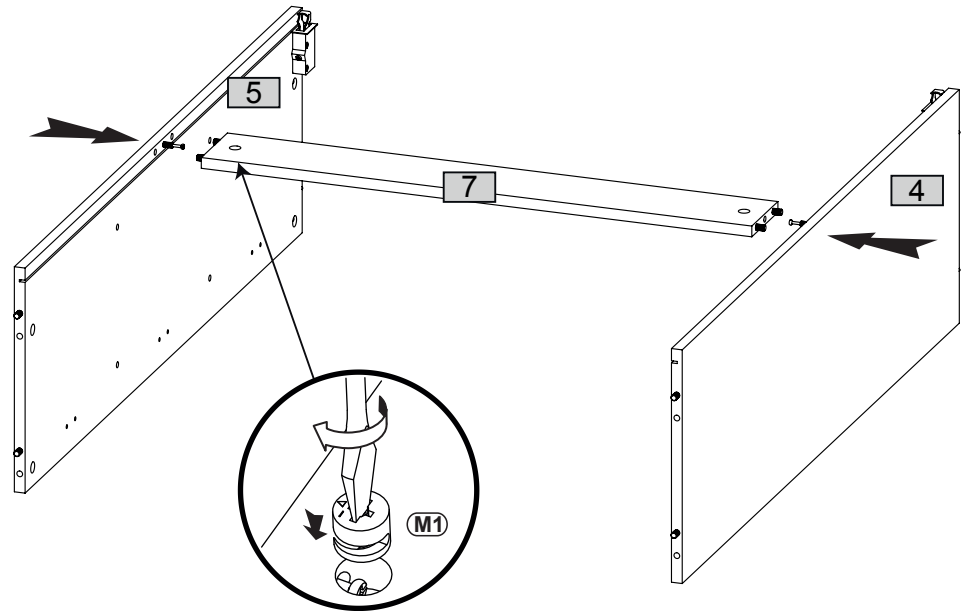

4

M1  x6

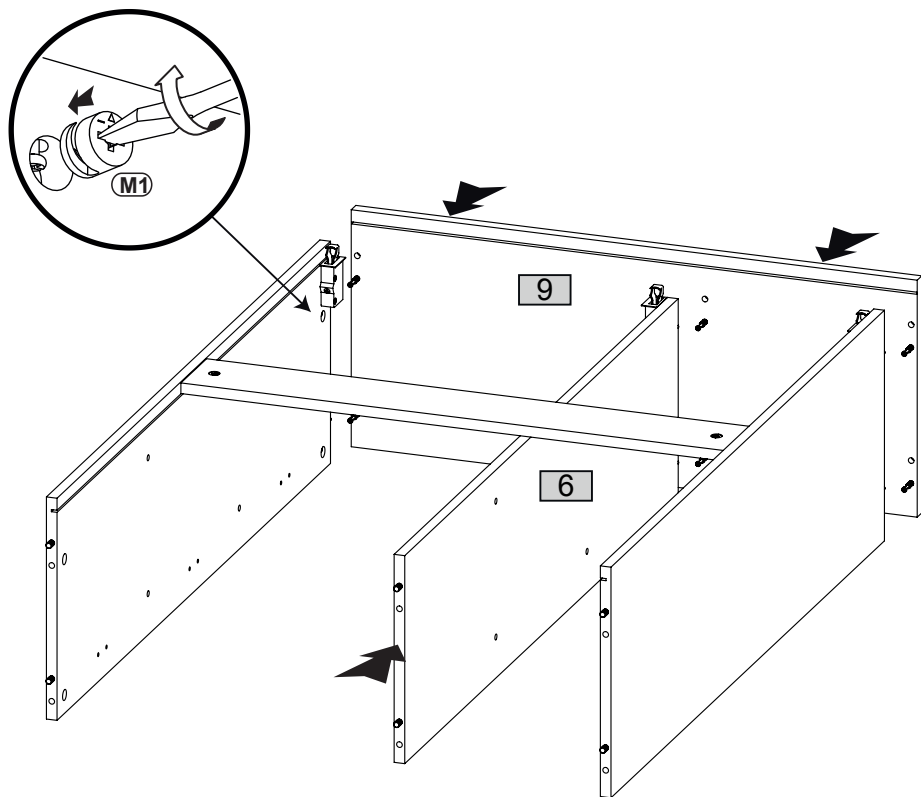

5

M1  x6

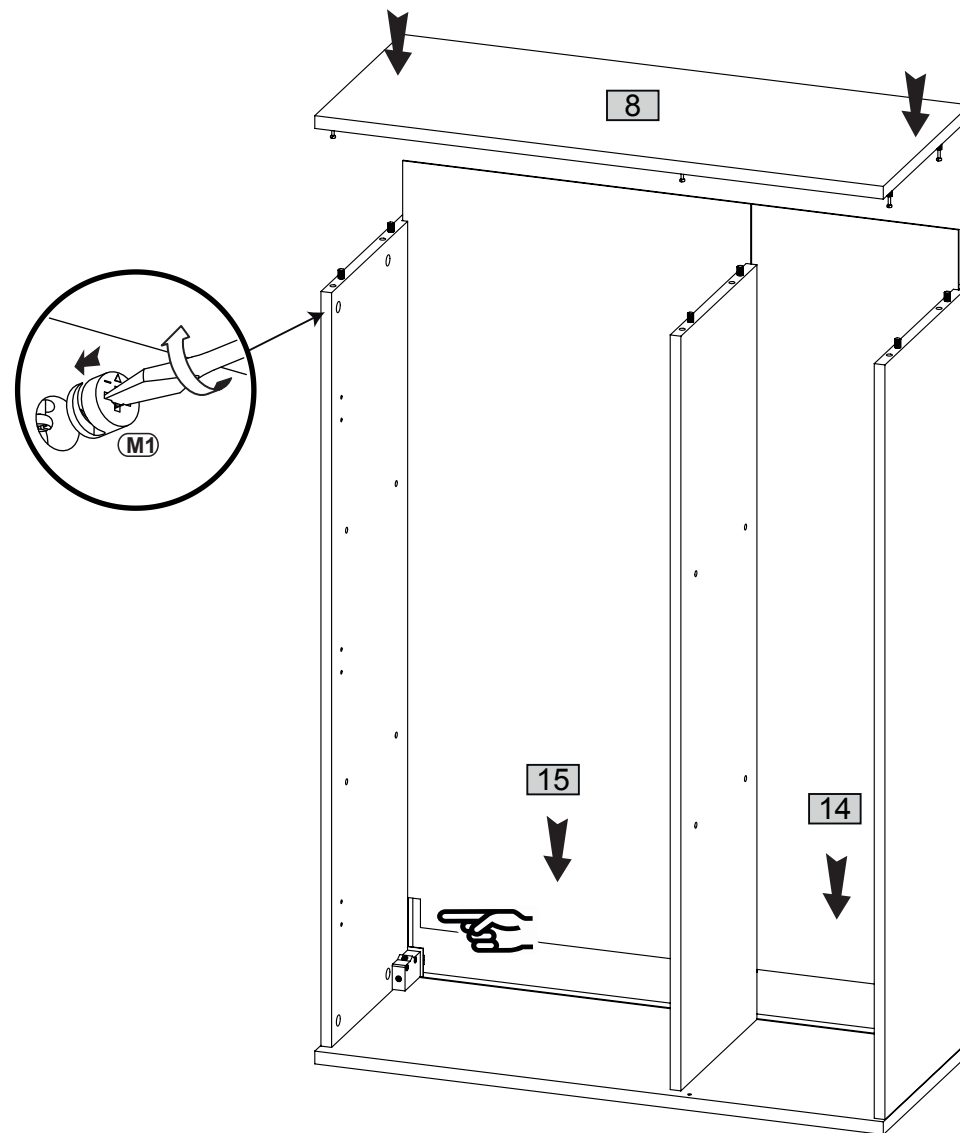



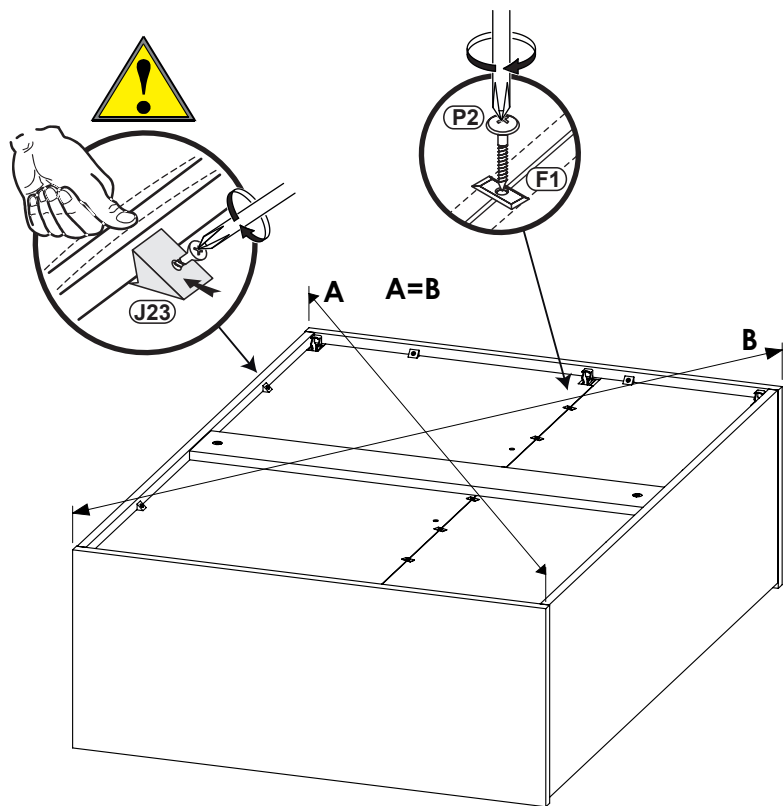
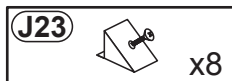
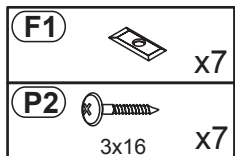

6

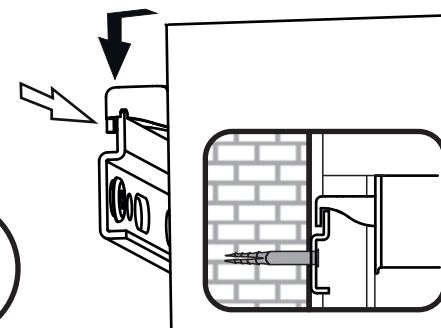
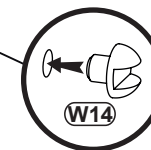
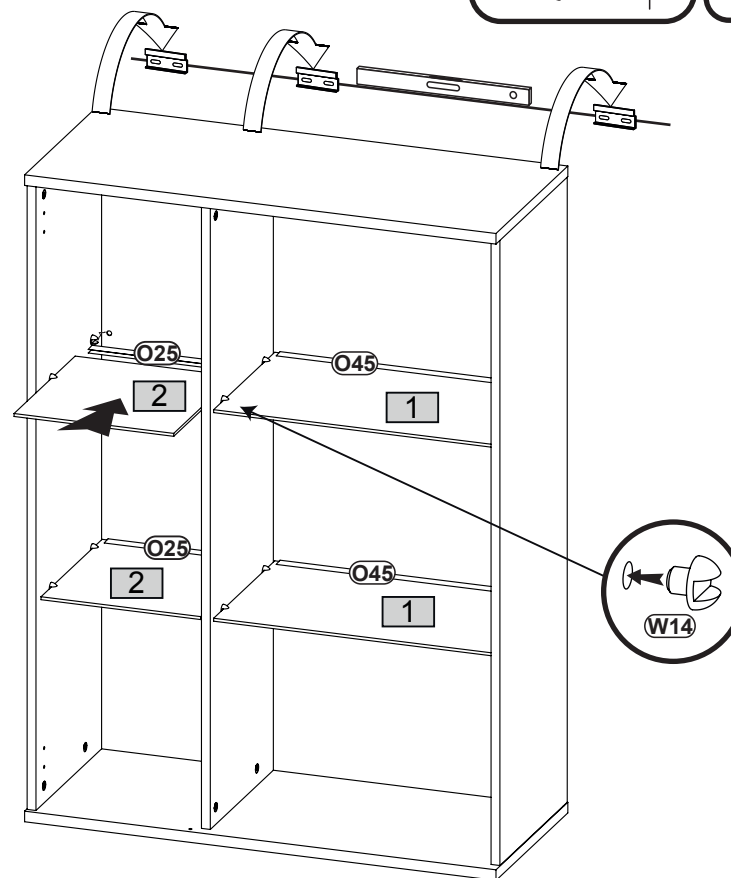
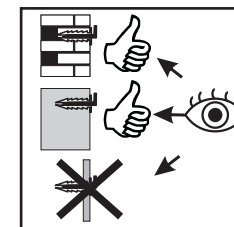
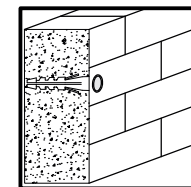
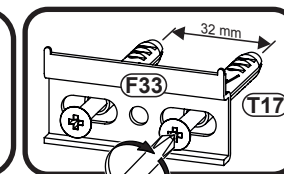
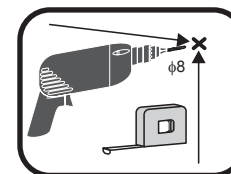
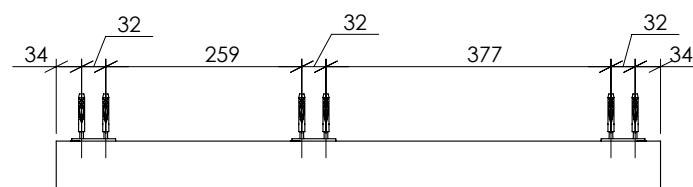
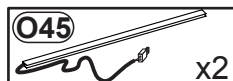
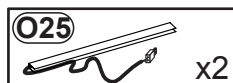
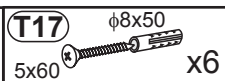
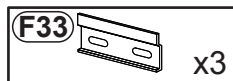

7

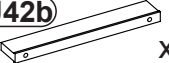

8

- U42a**  x1
- G4**  x2
- P16**  4x16 x2
- U42b**  x1
- P4**  4x25 x2

- C2**  ϕ 20 x12

- W2**  x2

