

<http://www.bega-gruppe.de>

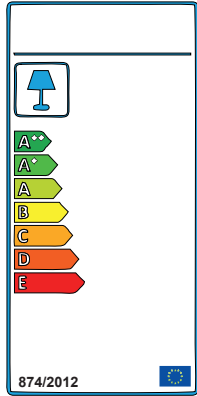

BG	Bulgarisch	български
CS	Tschechisch	čeština
DA	Dänisch	Dansk
DE	Deutsch	Deutsch
ET	Estnisch	Eesti
EL	Griechisch	ελληνικά
EN	Englisch	English
ES	Spanisch	español
FR	Französisch	Français
FI	Finnisch	suomalainen
HR	Kroatisch	hrvatski
HU	Ungarisch	magyar
IT	Italienisch	Italiano
LV	Lettisch	Latvijas
LT	Litauisch	Lietuvos
NL	Niederländisch	Nederlands
PL	Polnisch	Polski
PT	Portugiesisch	português
RO	Rumänisch	român
SK	Slowakisch	slovenský
SL	Slowenisch	slovenščina
SV	Schwedisch	Svenska

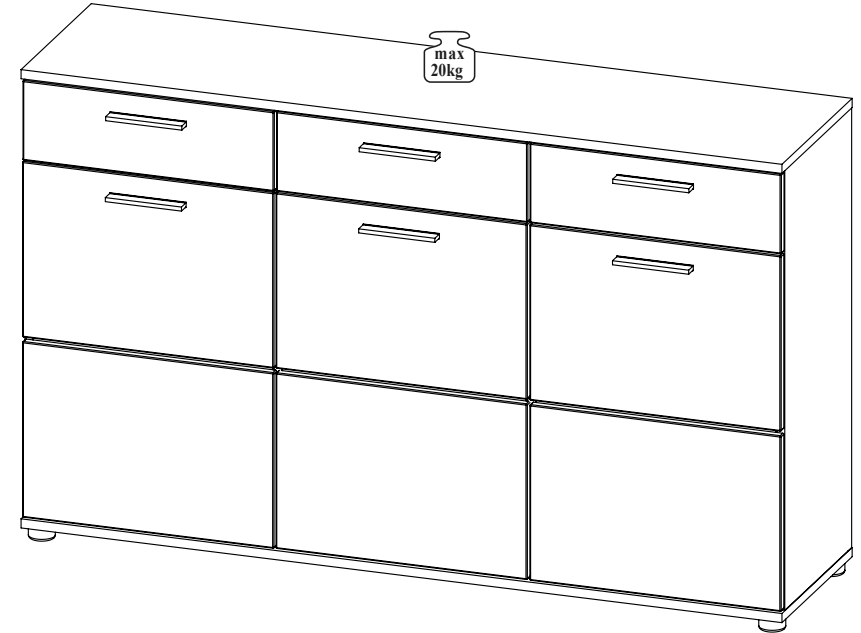

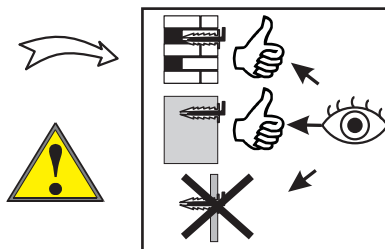
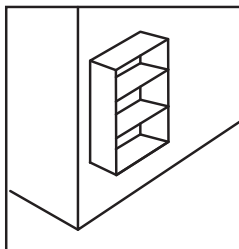
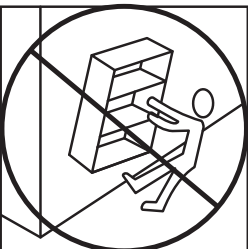
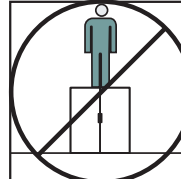
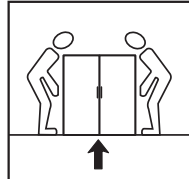
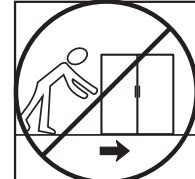
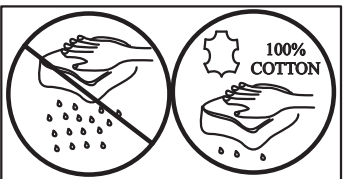
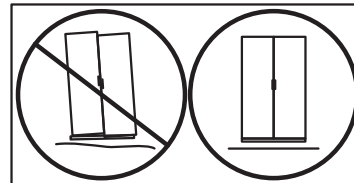
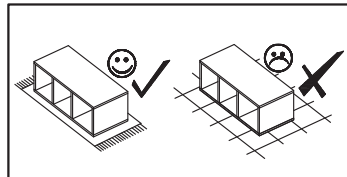
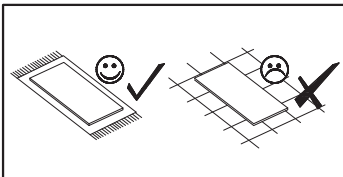
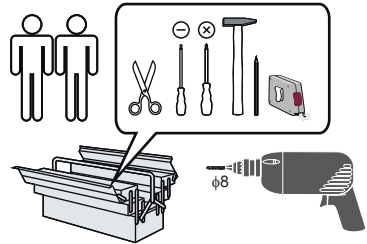
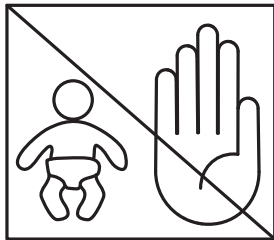
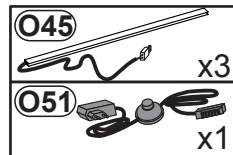
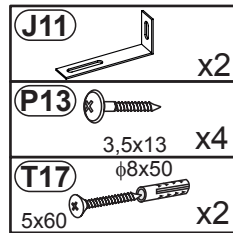
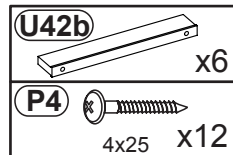
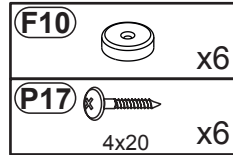
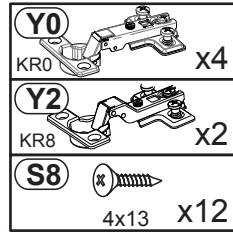
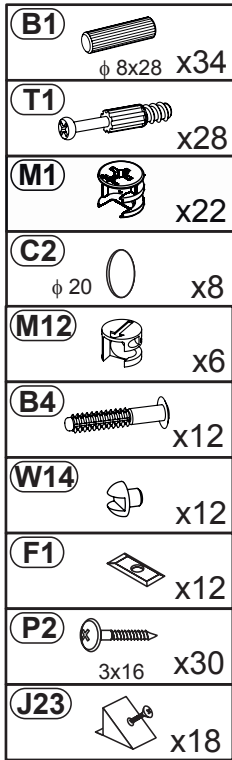

Nr	Ausmaß	St	Colli
1	471 330	5 2	1
2	480 330	5 1	1
3	867 362	15 1	2
4	867 362	15 1	2
5	300 100	12 3	2
6	300 100	12 3	2
7	867 342	15 1	2
8	867 342	15 1	2
9	476 98	15 2	2
10	485 82	15 1	2
11	427 100	12 2	2
12	436 100	12 1	2
13	1499 380	18 2	1
14	495 157	16 1	2
15	495 157	16 1	2
16	495 157	16 1	2
17	346 495	16 2	1
18	346 495	16 2	1
19	346 495	16 1	1
20	346 495	16 1	1
21	472 70	4 2	1
22	480 70	4 1	1
23	438 299	2 2	2
24	447 299	2 1	2
25	881 490	2 2	2
26	881 499	2 1	2

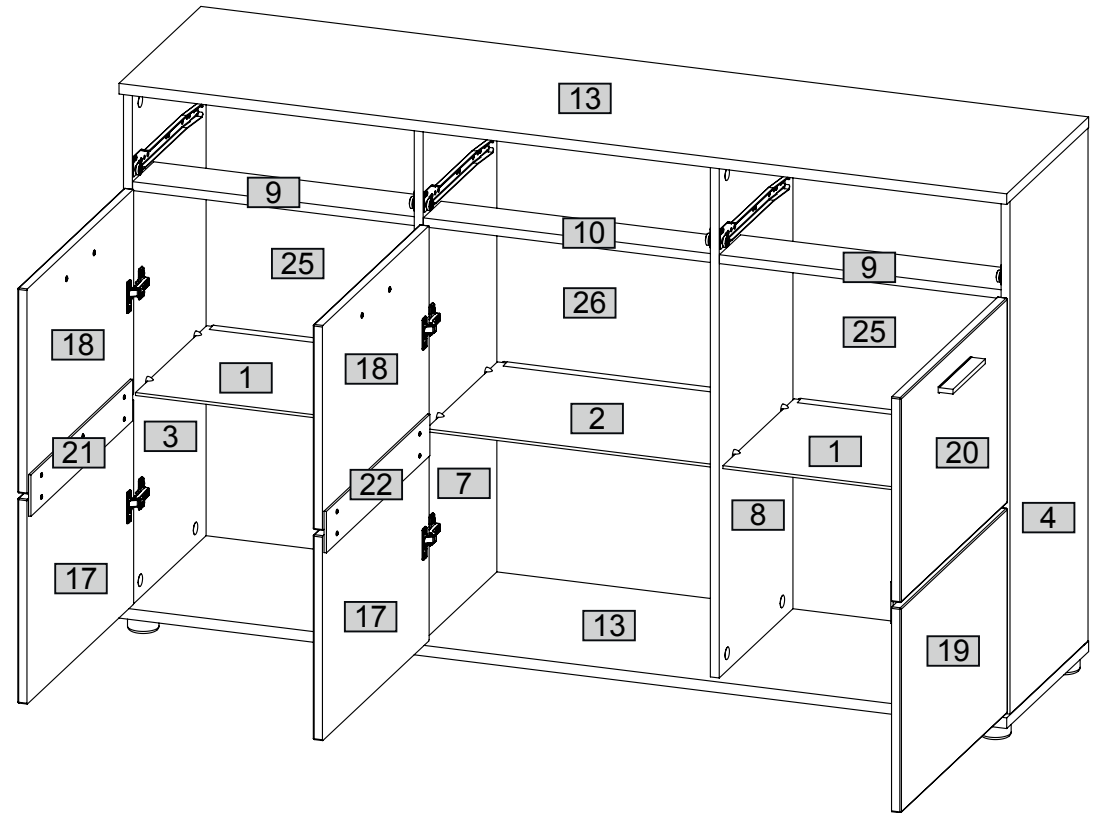
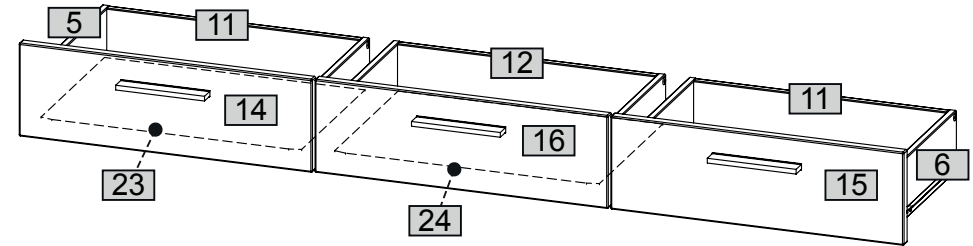

1

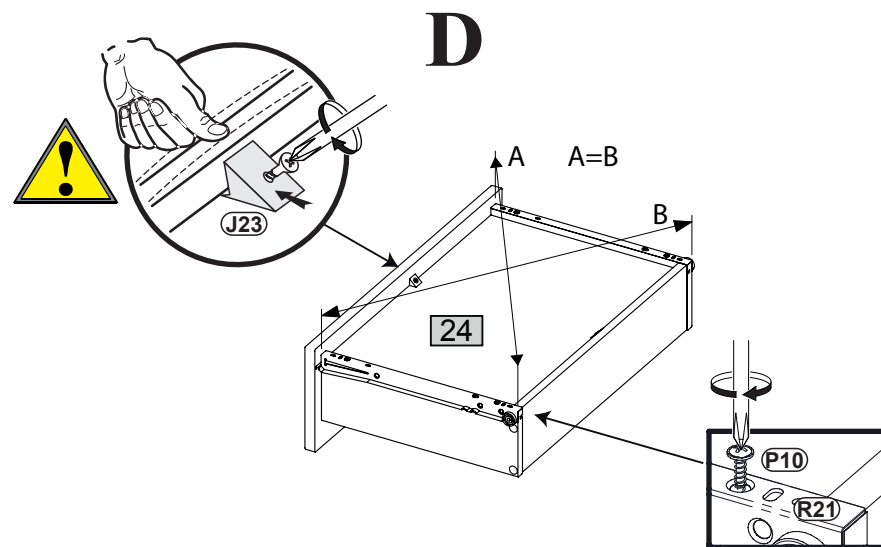
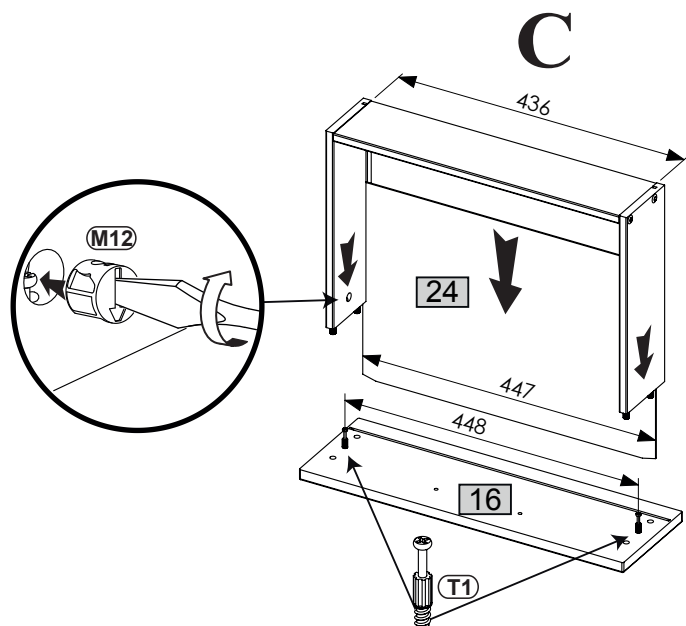
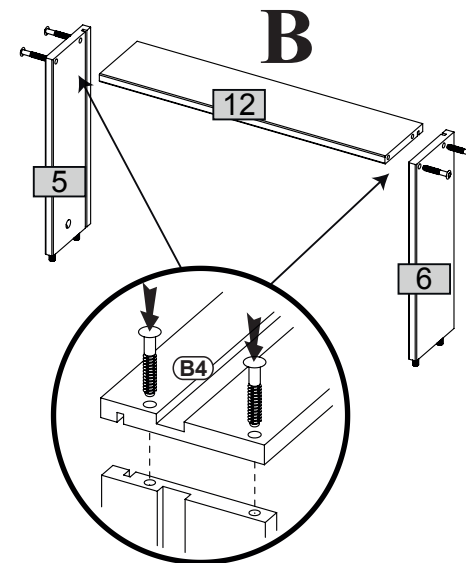
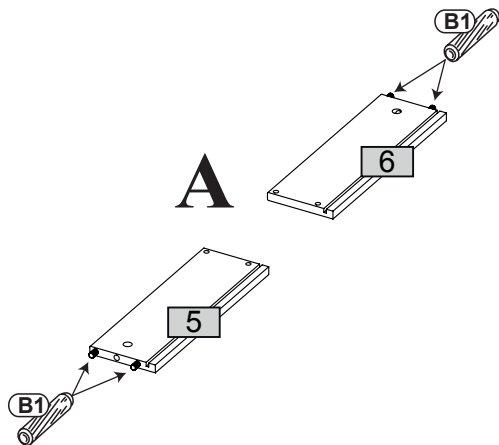
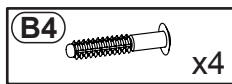
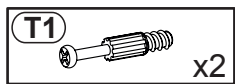
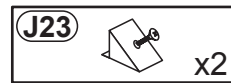
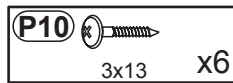
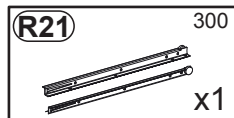
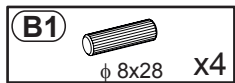

2

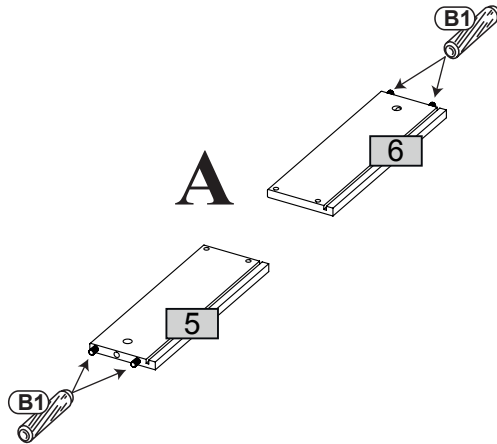
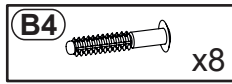
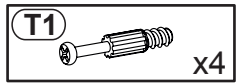
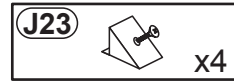
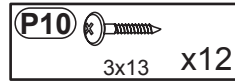
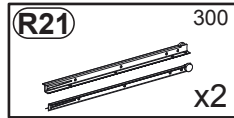
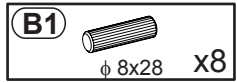

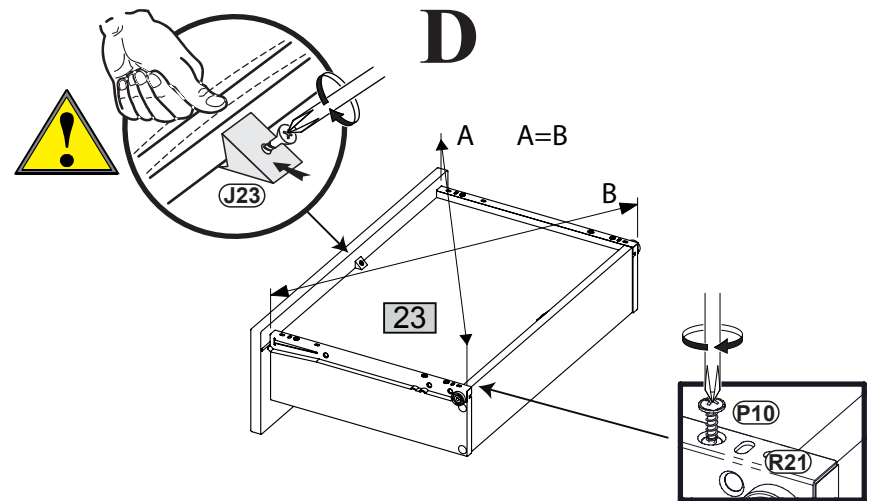
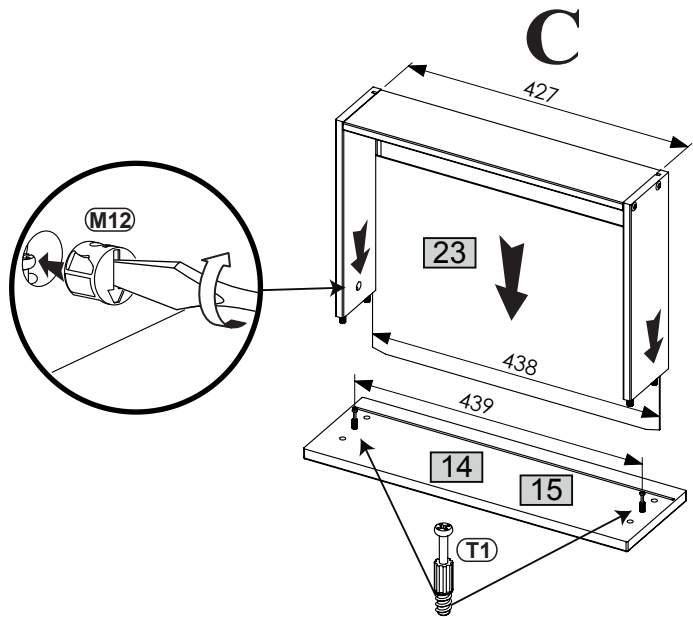
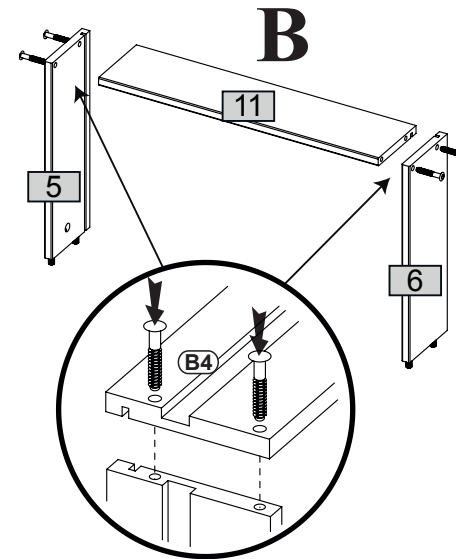

x2



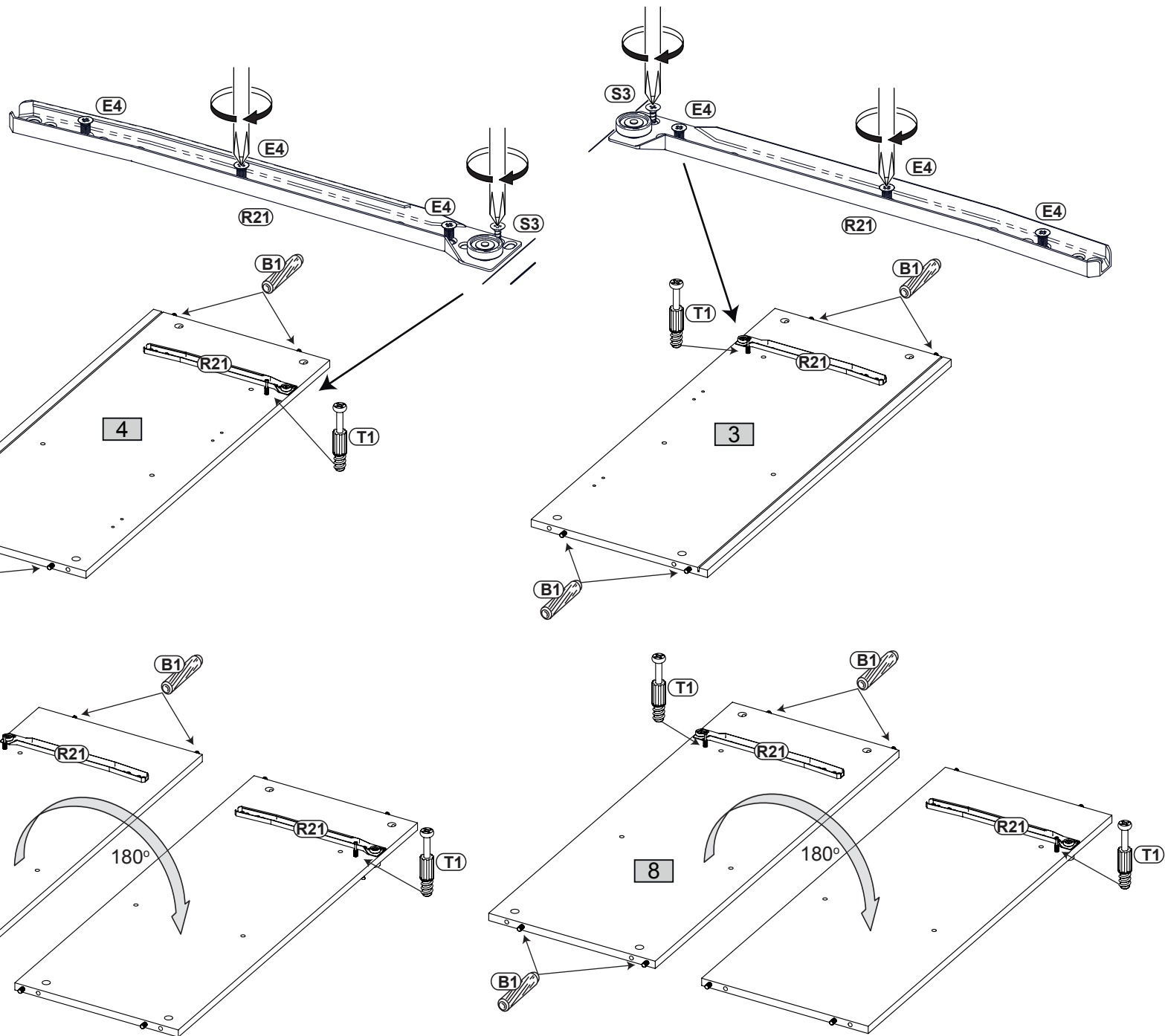
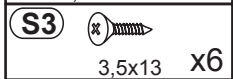
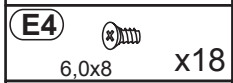
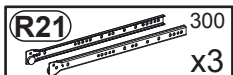
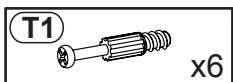
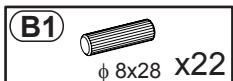

3



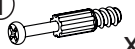

4

F10  x6
P17  4x20 x6

T1  x16

Y0  KR0 x4

Y2  KR8 x2

S8  4x13 x12

P2  3x16 x18

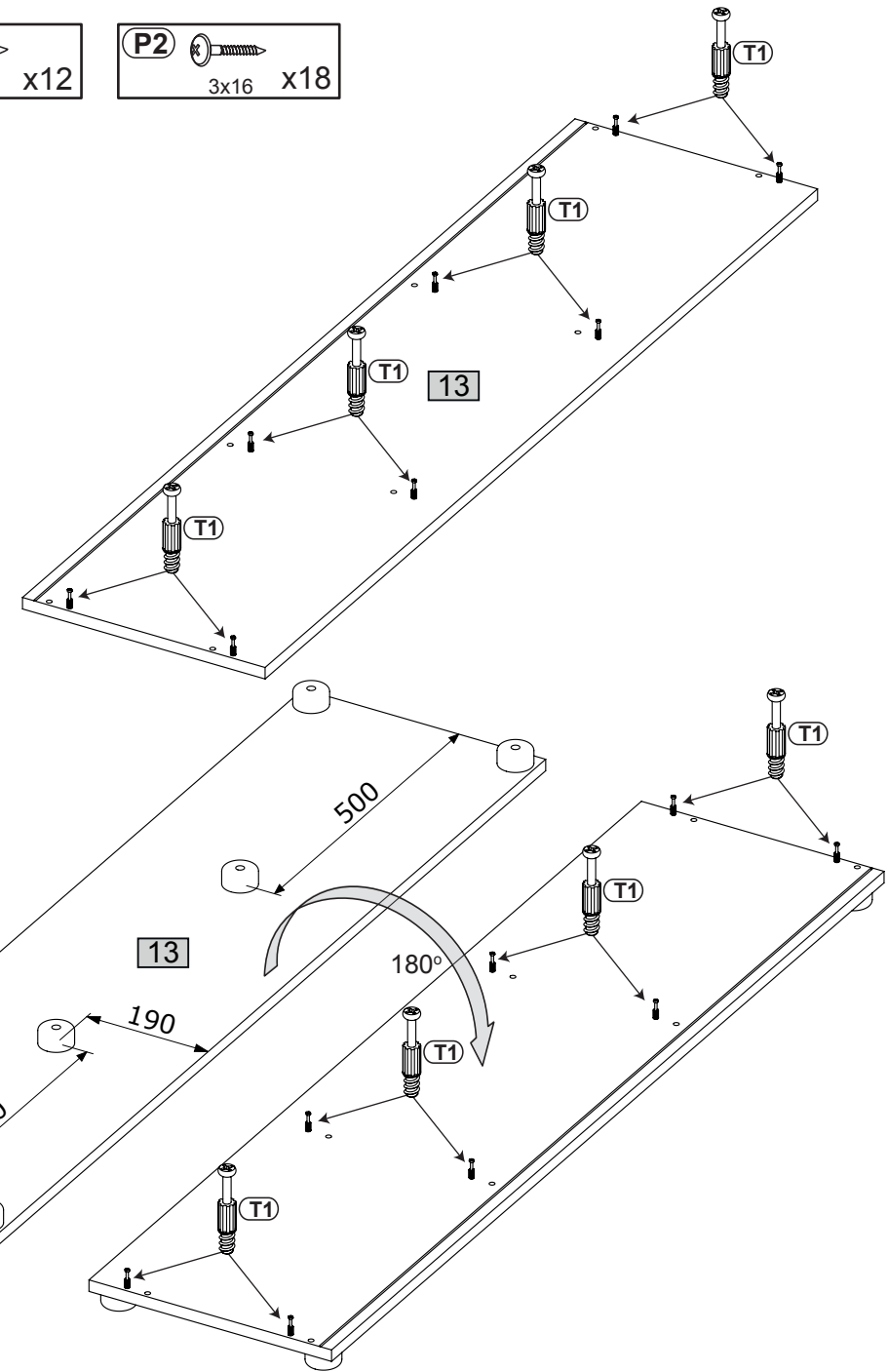
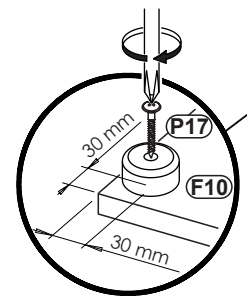
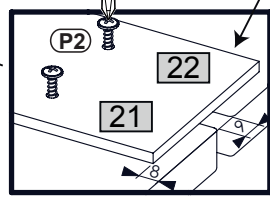
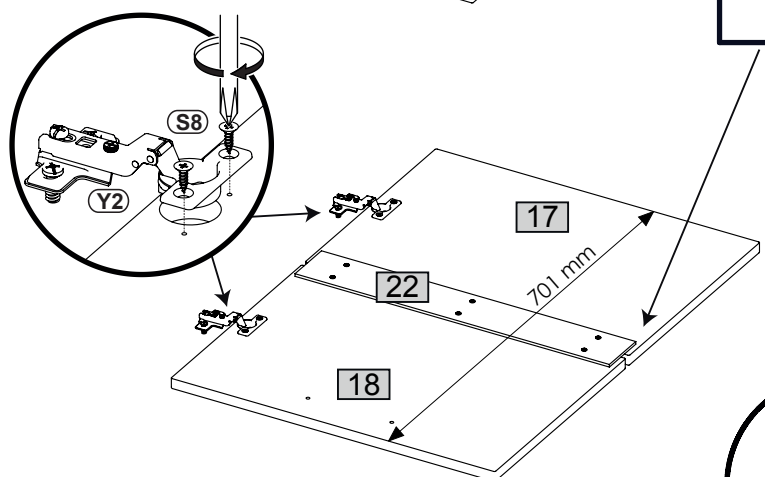
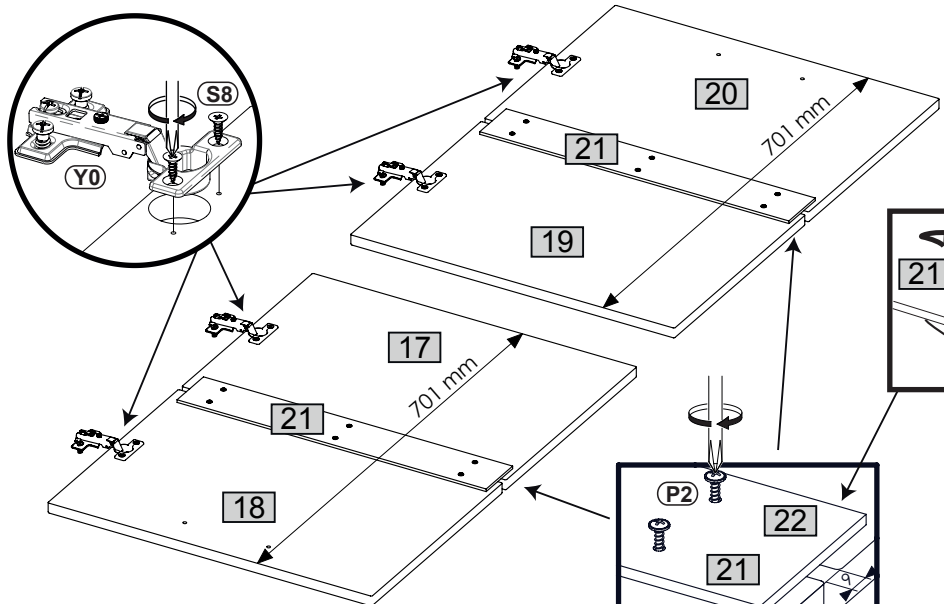

5 **M1**  x6

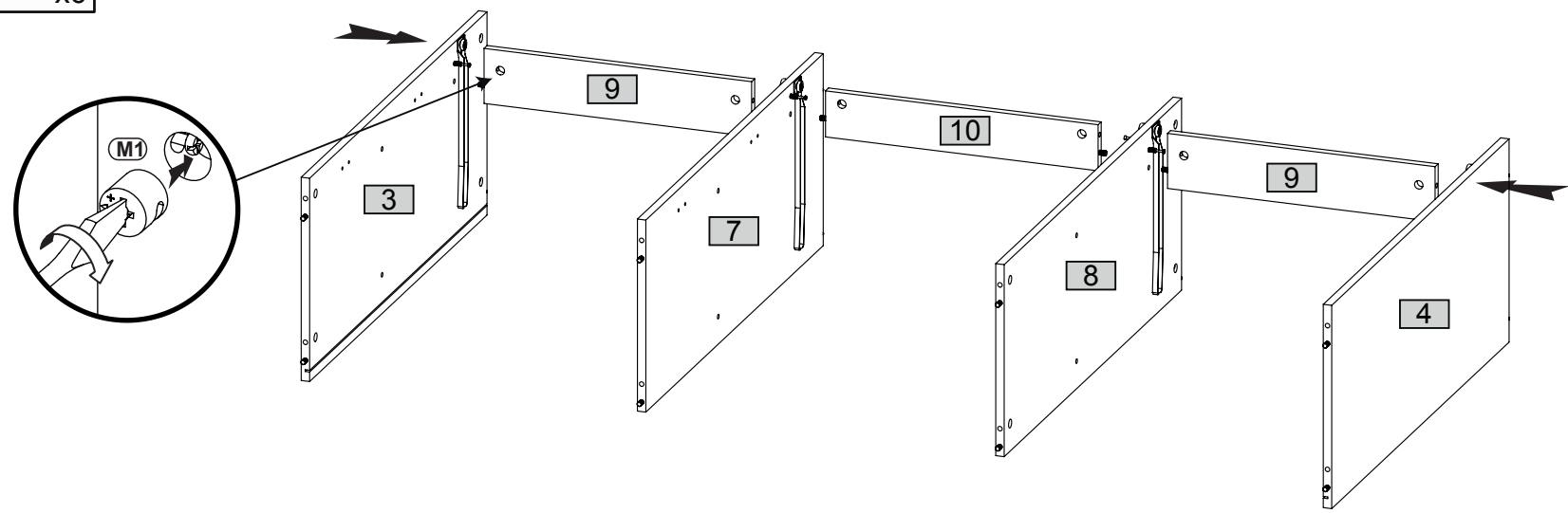

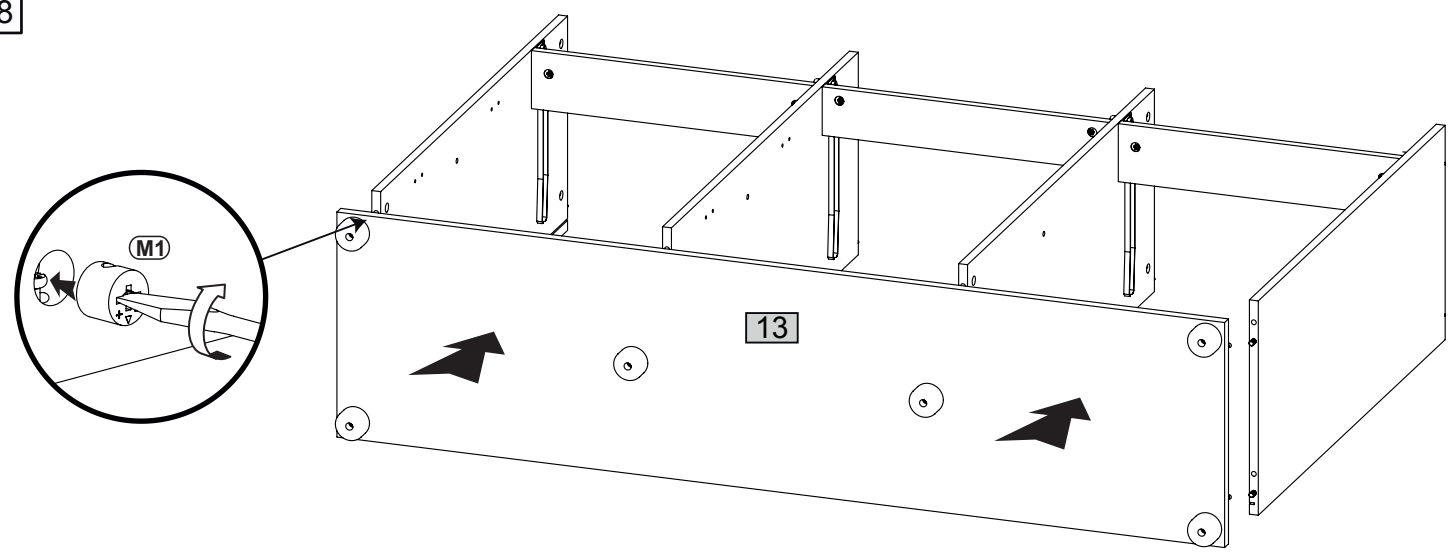

6 **M1**  x8

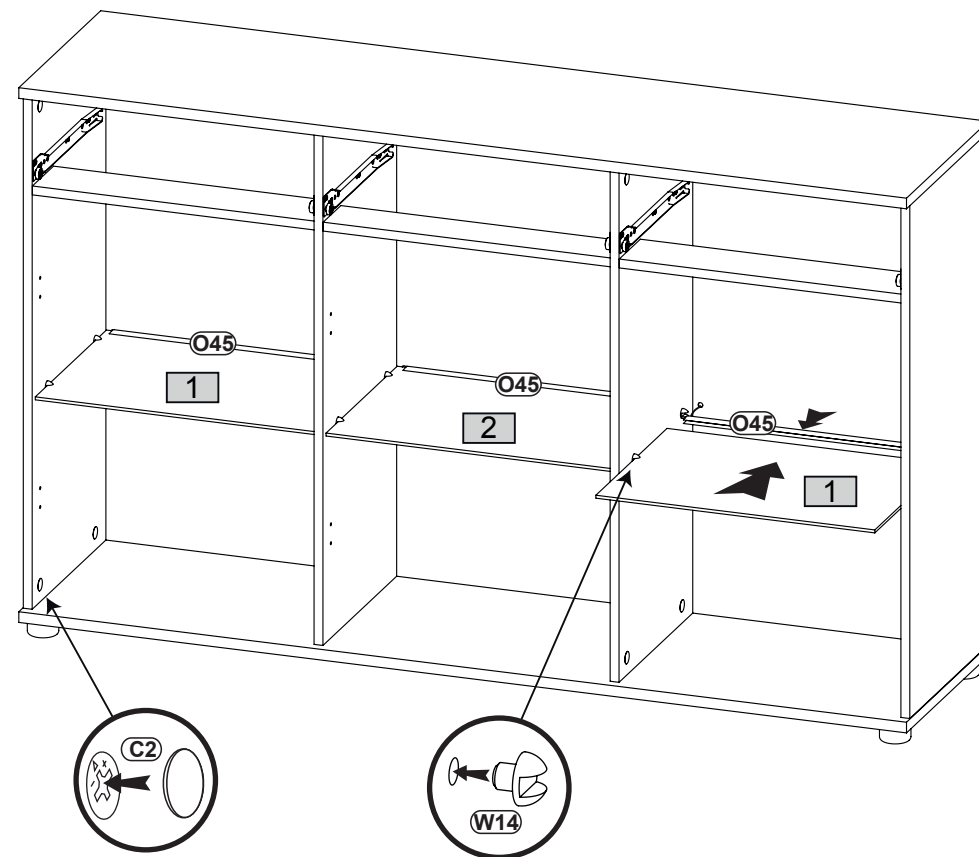
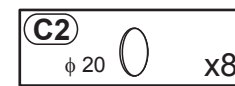
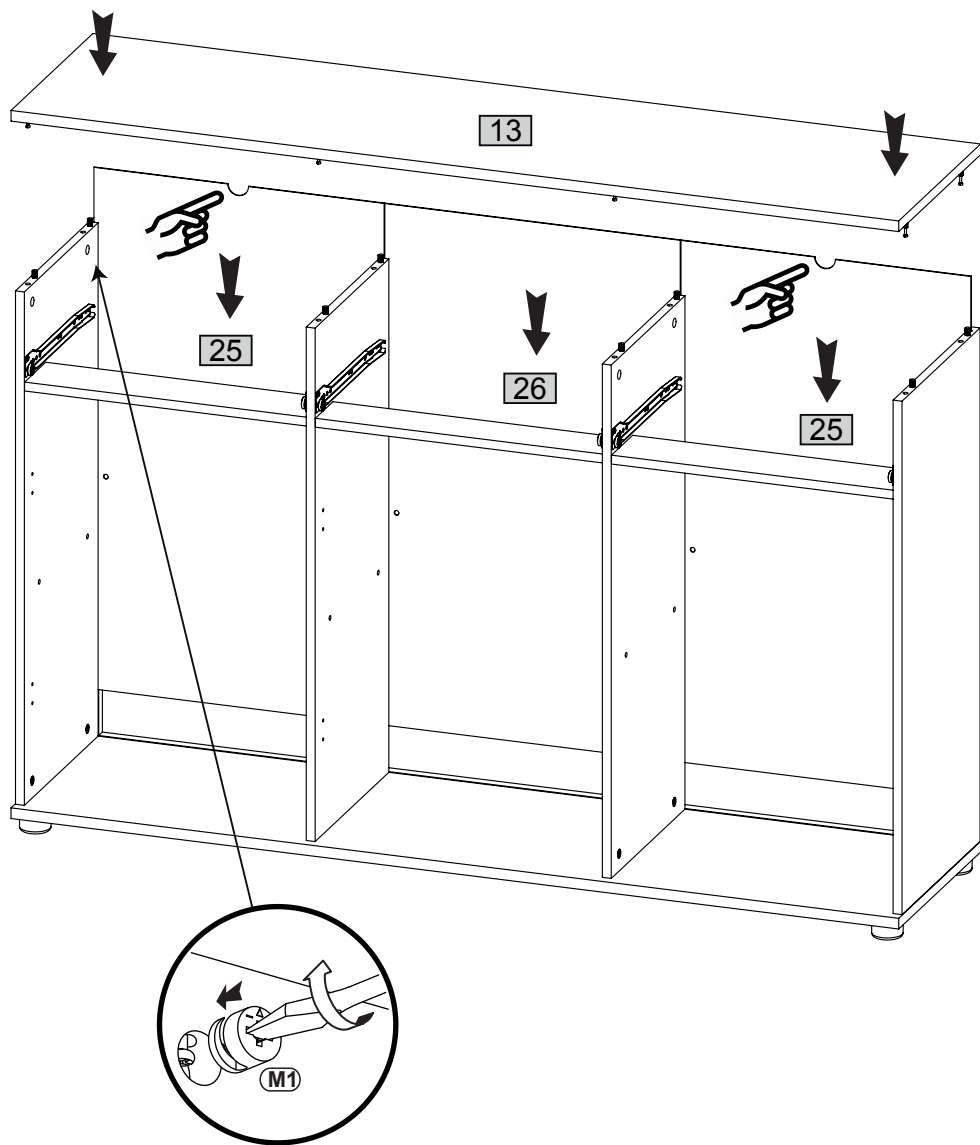



9

F1  x12

P2  3x16 x12

J23  x12

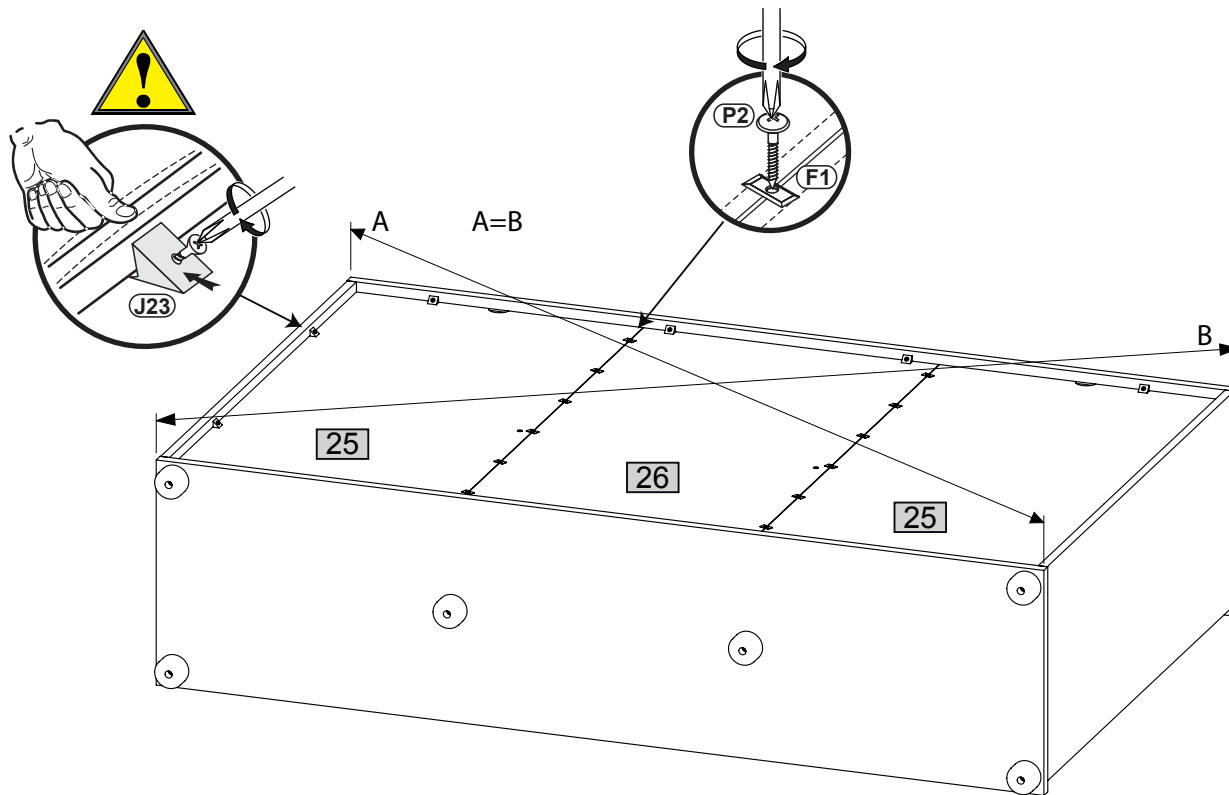

10

