



# MOUNTAIN PANEEL

1/4



wyprodukowano dla / made for / produziert für  
**BEGA GRUPPE**  
producent: **MEBLE OKMED** POLAND

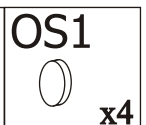
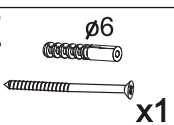
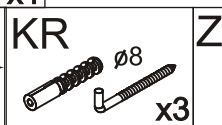
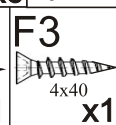
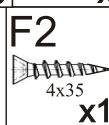
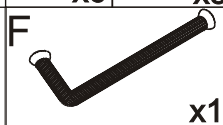
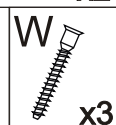
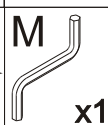
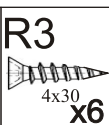
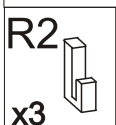
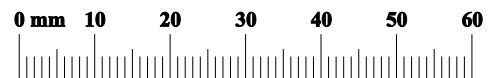
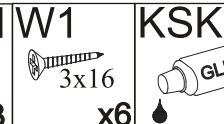
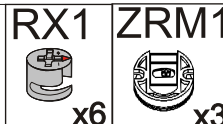
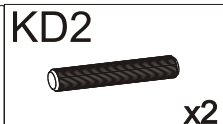
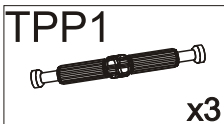
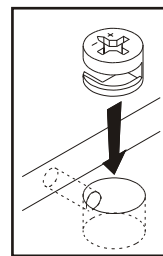
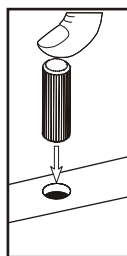
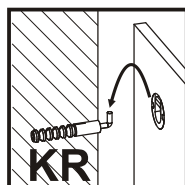
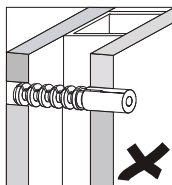
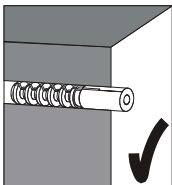
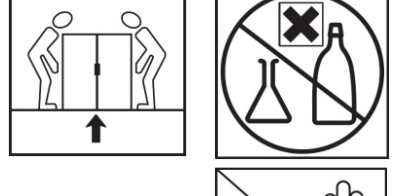
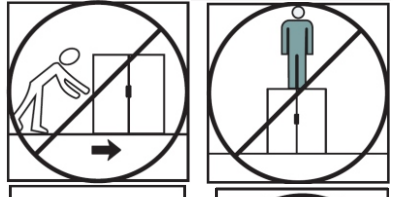
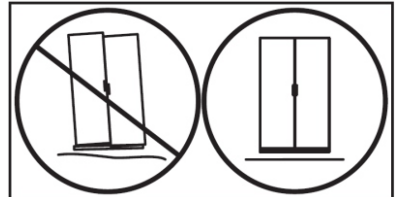
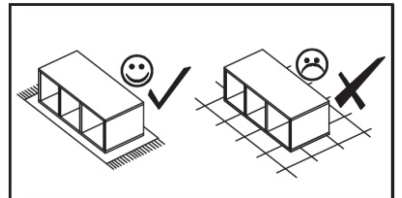
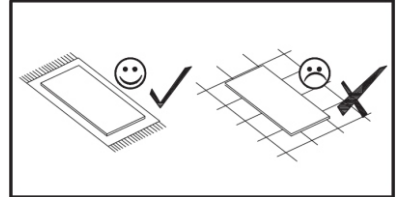
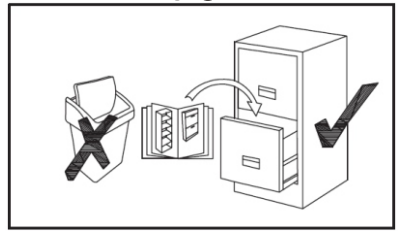
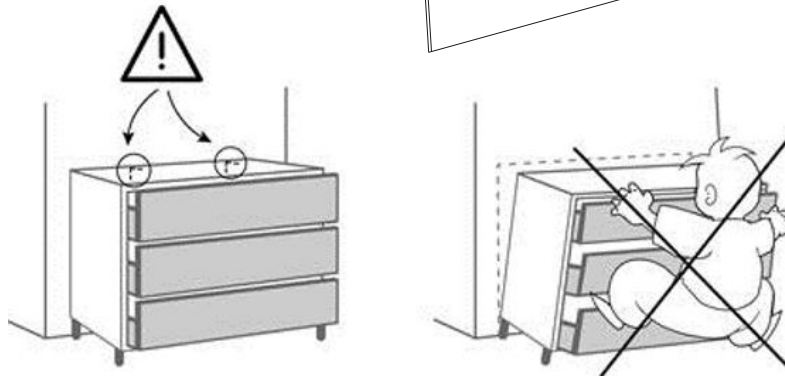
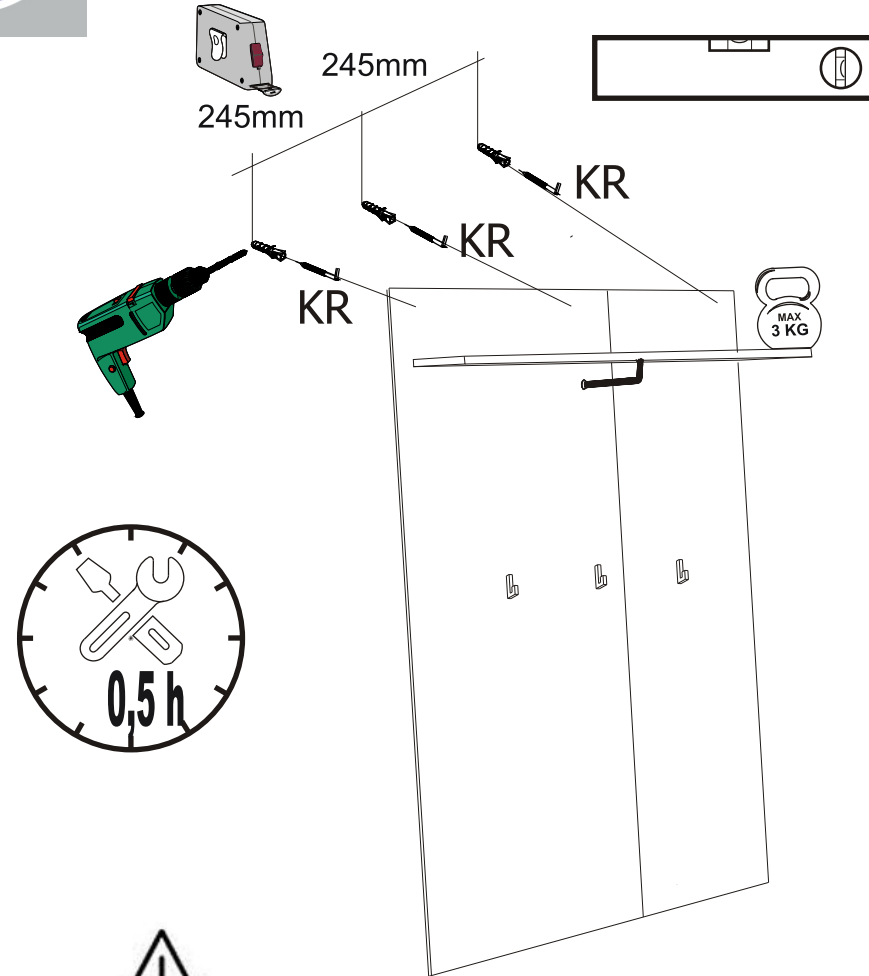
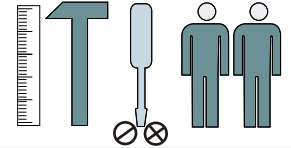

# MOUNTAIN PANEEL

2/4

01

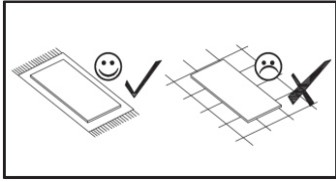

KD2

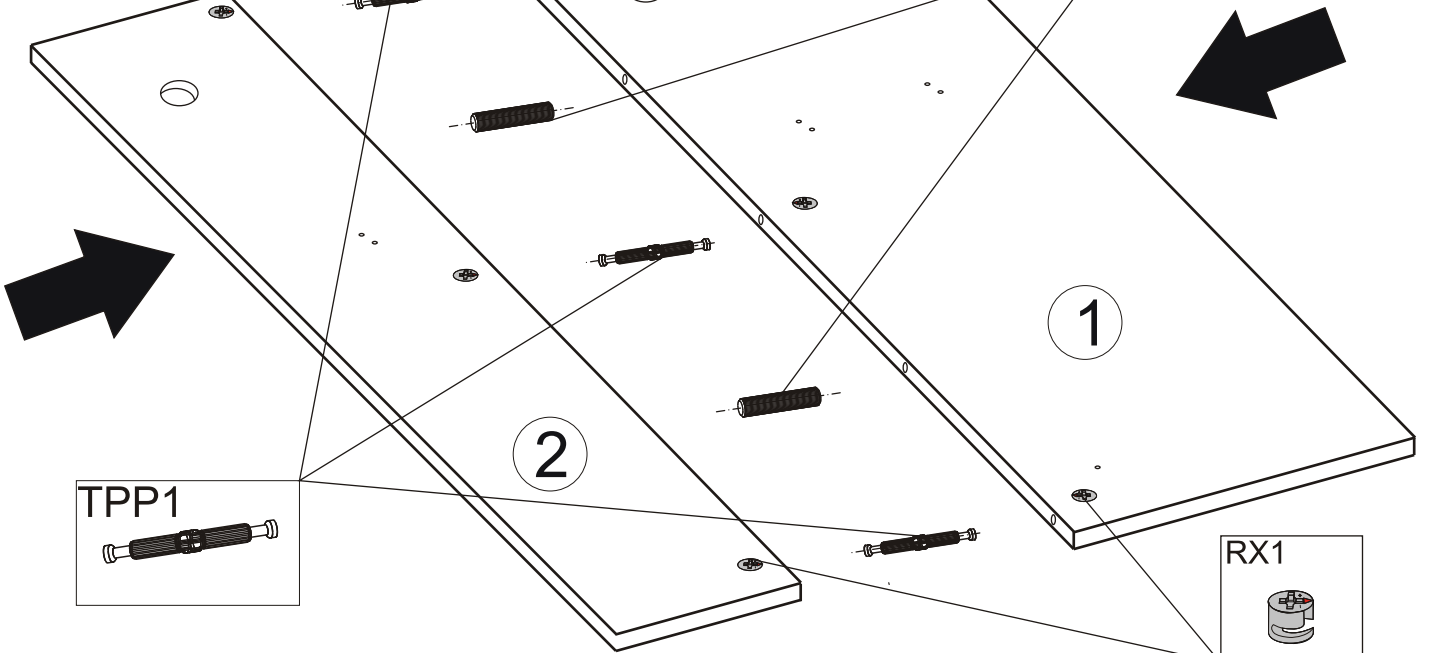

TPP1



RX1



02

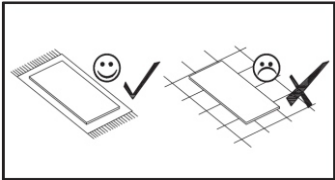

ZRM1



GLUE



ZRM1

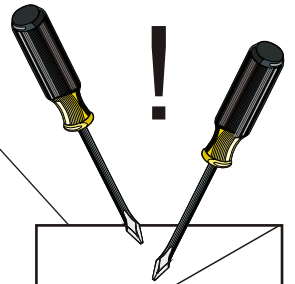

W1

3x16



W1

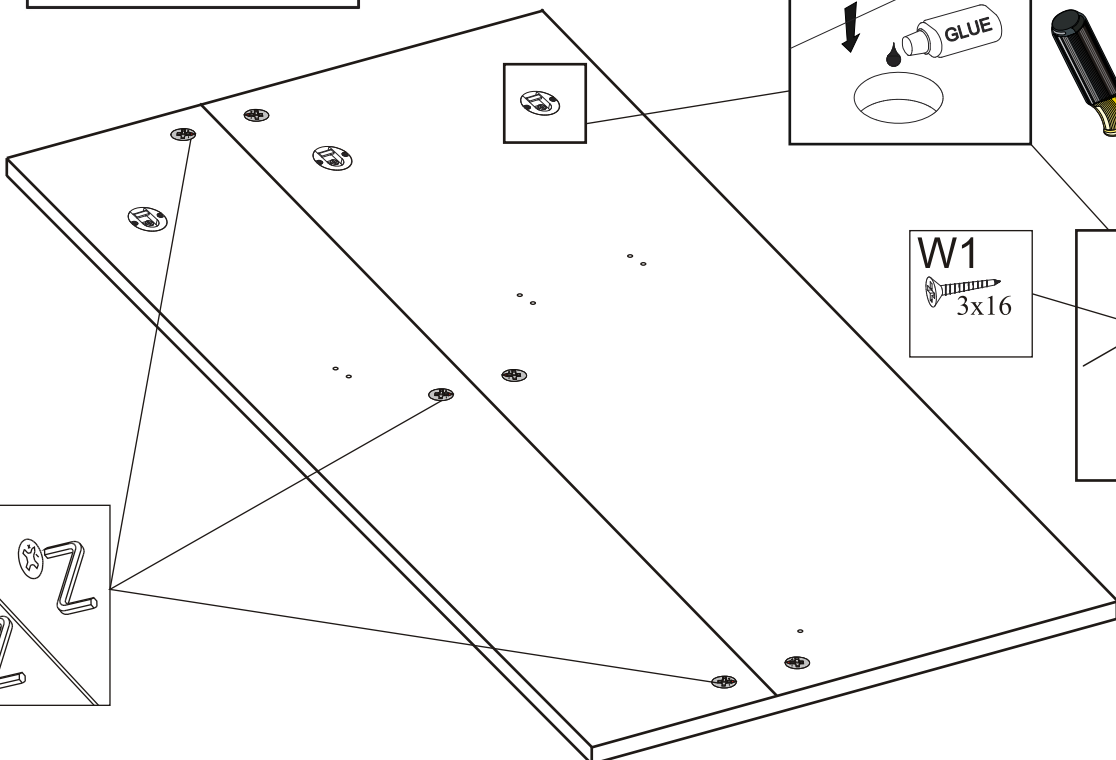
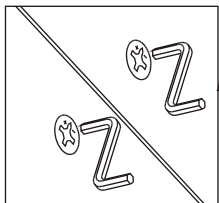

# MOUNTAIN PANEEL

3/4

03

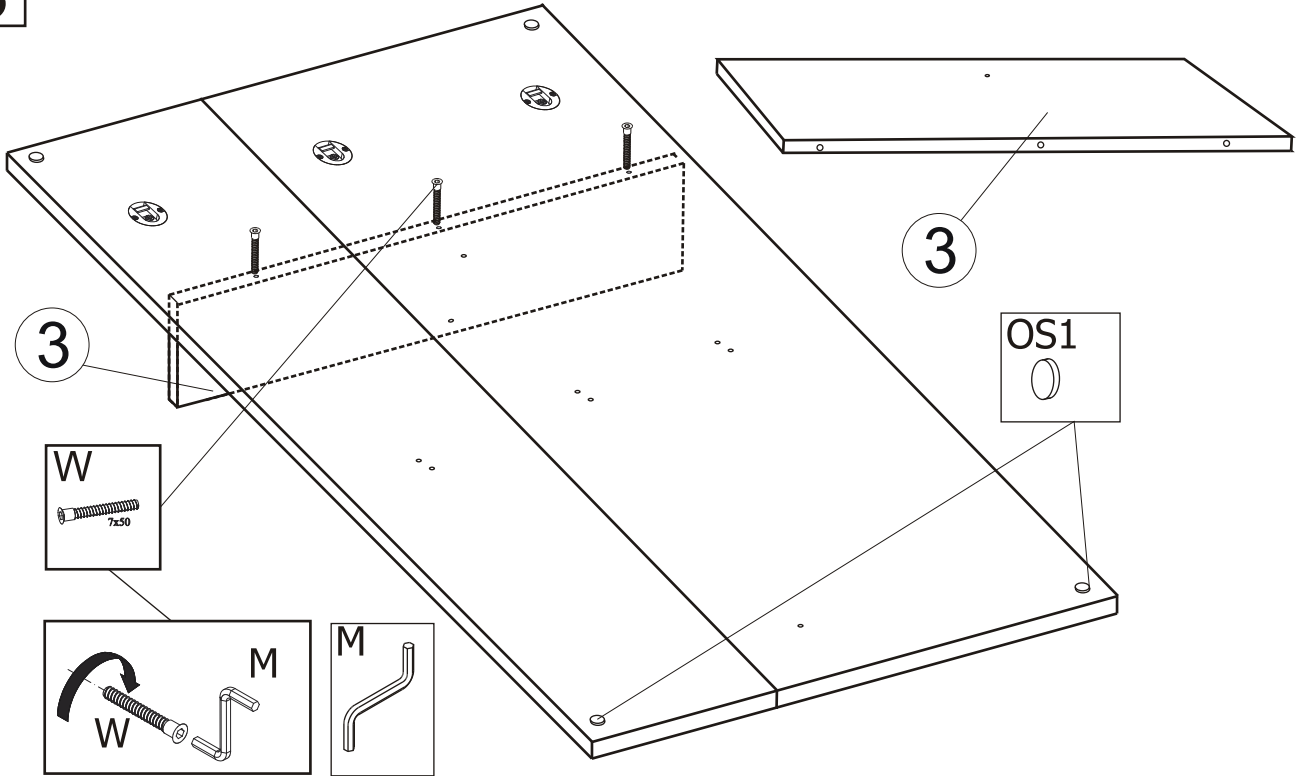

04

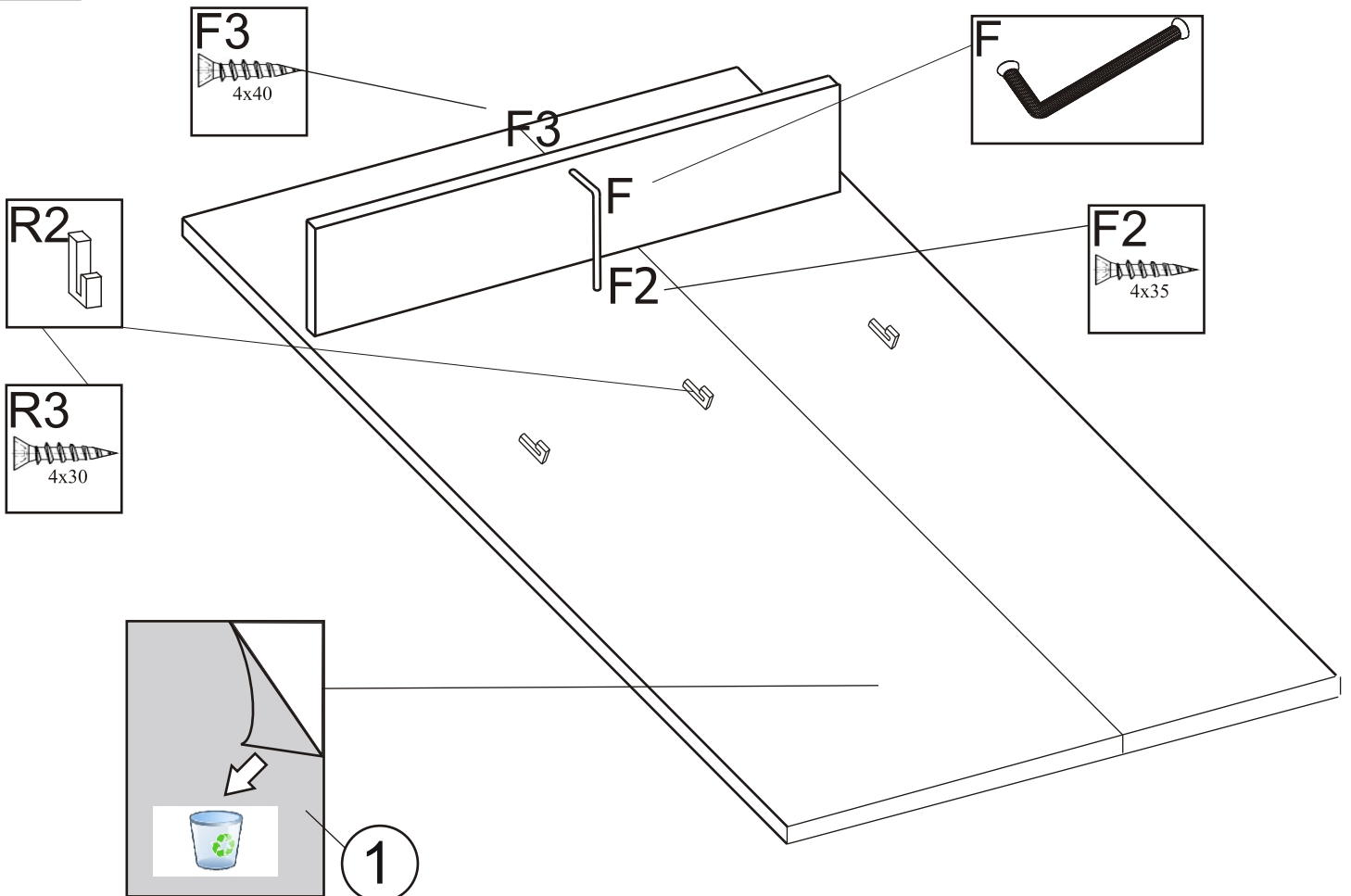

# MOUNTAIN PANEEL

4/4

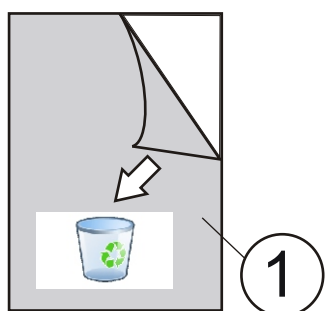
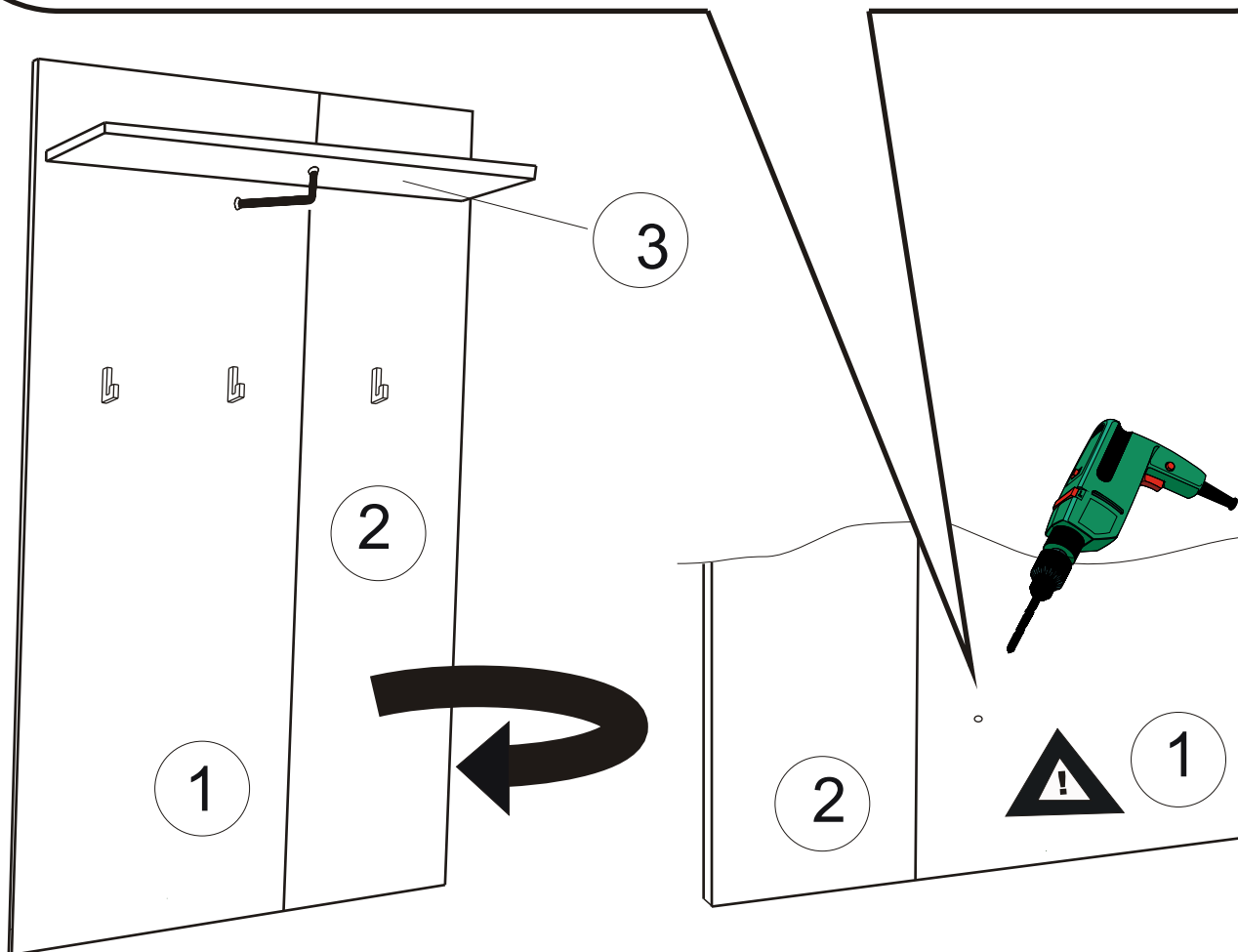
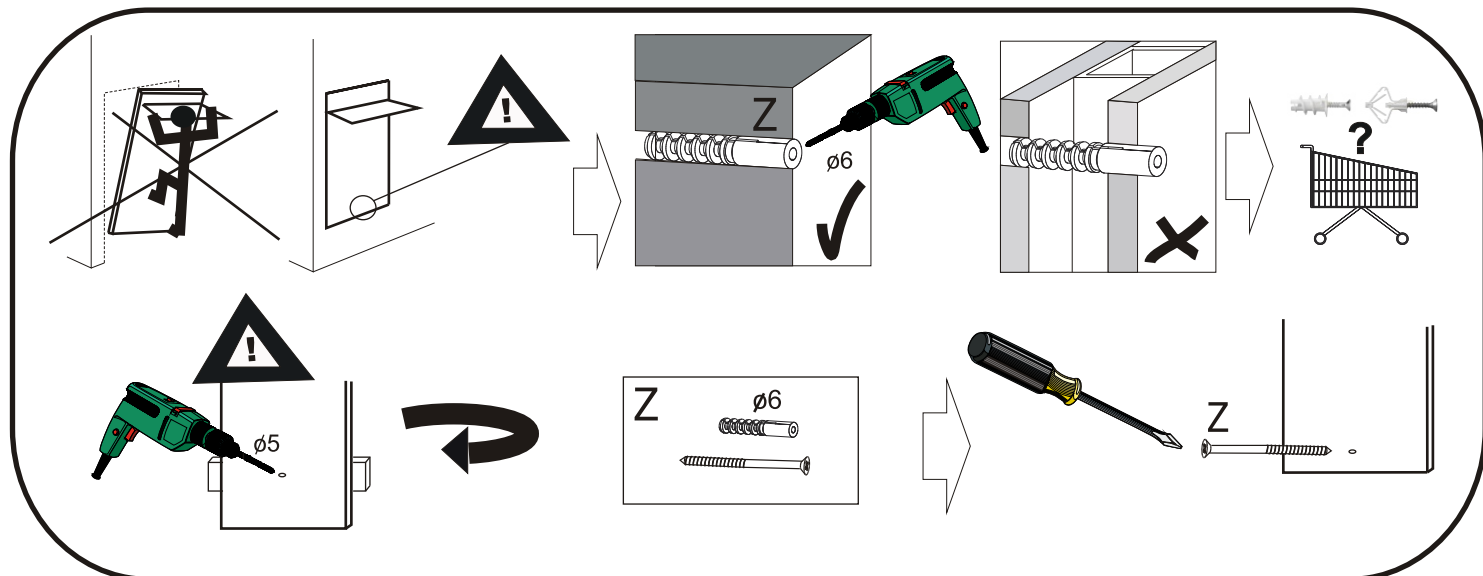

1	EL-MOU-GAR-WIESZAK-PL-TW-L-BI_SQ	16x405x1250	x1
2	EL-MOU-GAR-WIESZAK-PL-TW-P-BE	16x242x1250	x1
3	EL-MOU-GAR-WIESZAK-WIENIEC-BE	16x260x647	x1