

A	B	C (mm)		D
1	M217-0004	1208	446	1/4
2	M217-1006	1258	322	1/4
3	M217-1007	1258	322	1/4
4	M217-1008	1258	302	1/4
5	M217-2003	900	322	1/4
6	M217-2004	900	341	1/4
7	M217-3003	434	292	1/4
8	M217-3004	419	292	1/4
9	M217-5002	1214	60	1/4
10	M217-5003	901	60	1/4
11	M217-9001	1268,	447,	1/4
12	M217-9002	1268,	432,	1/4

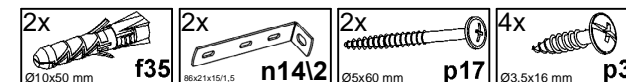

1

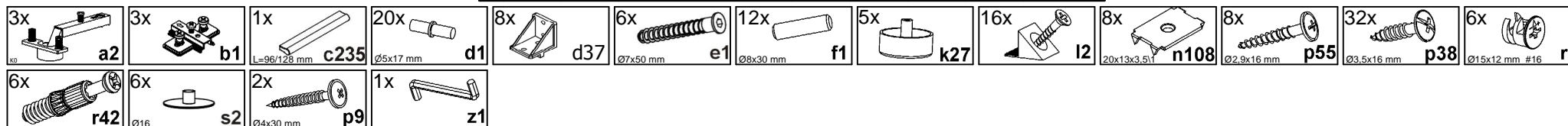
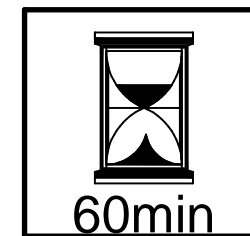
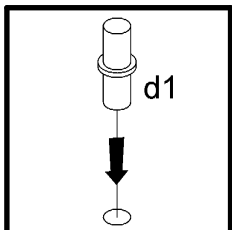
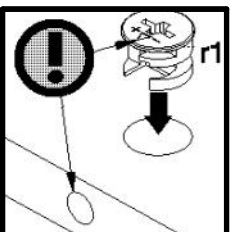
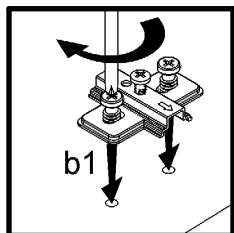
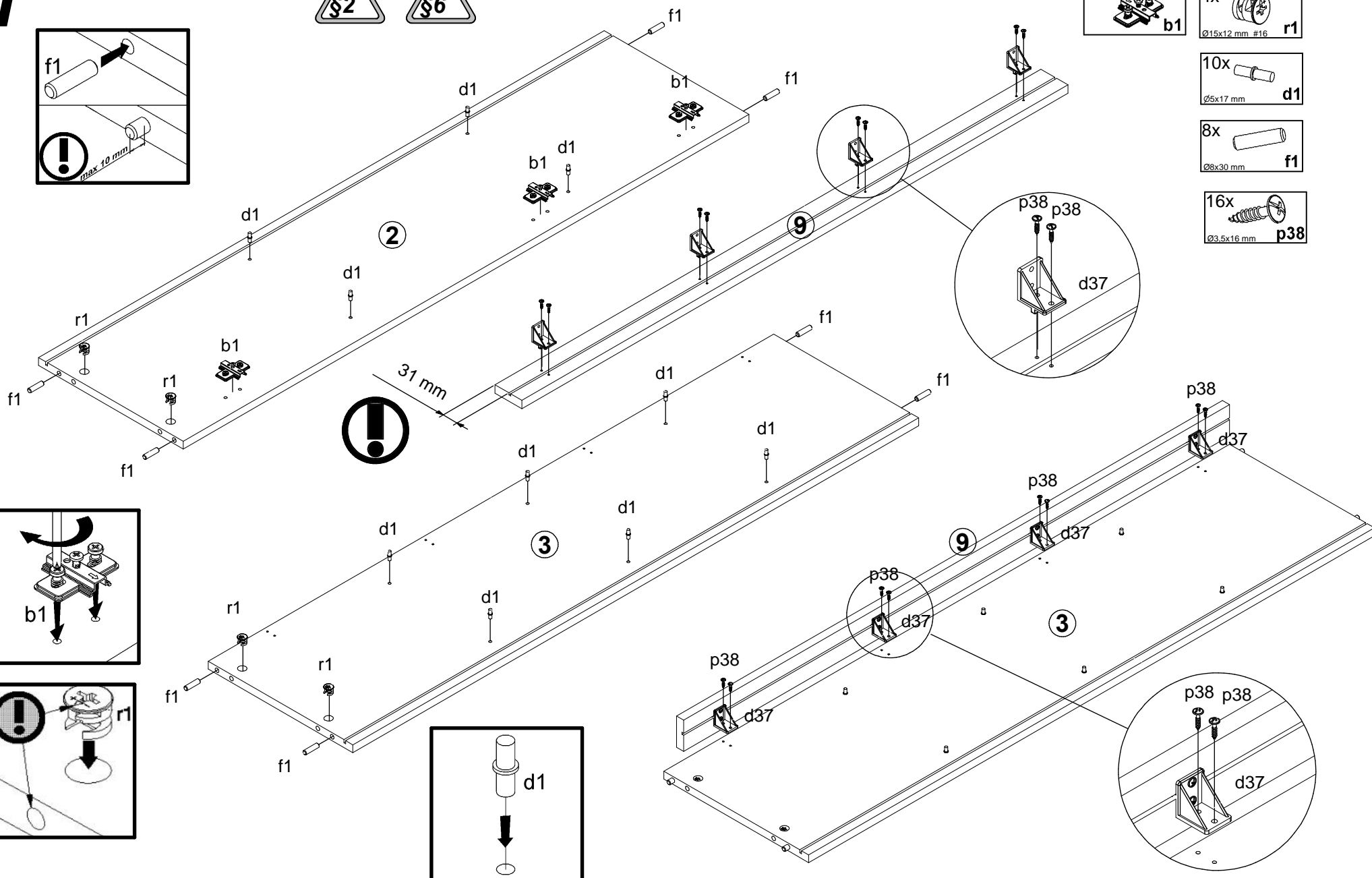
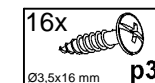
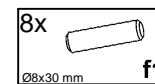
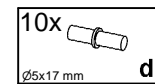
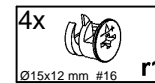
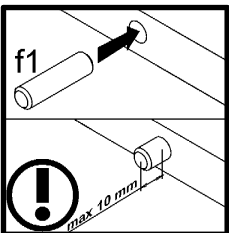

1

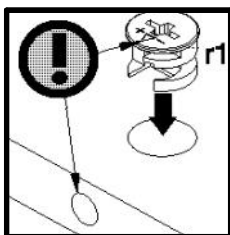
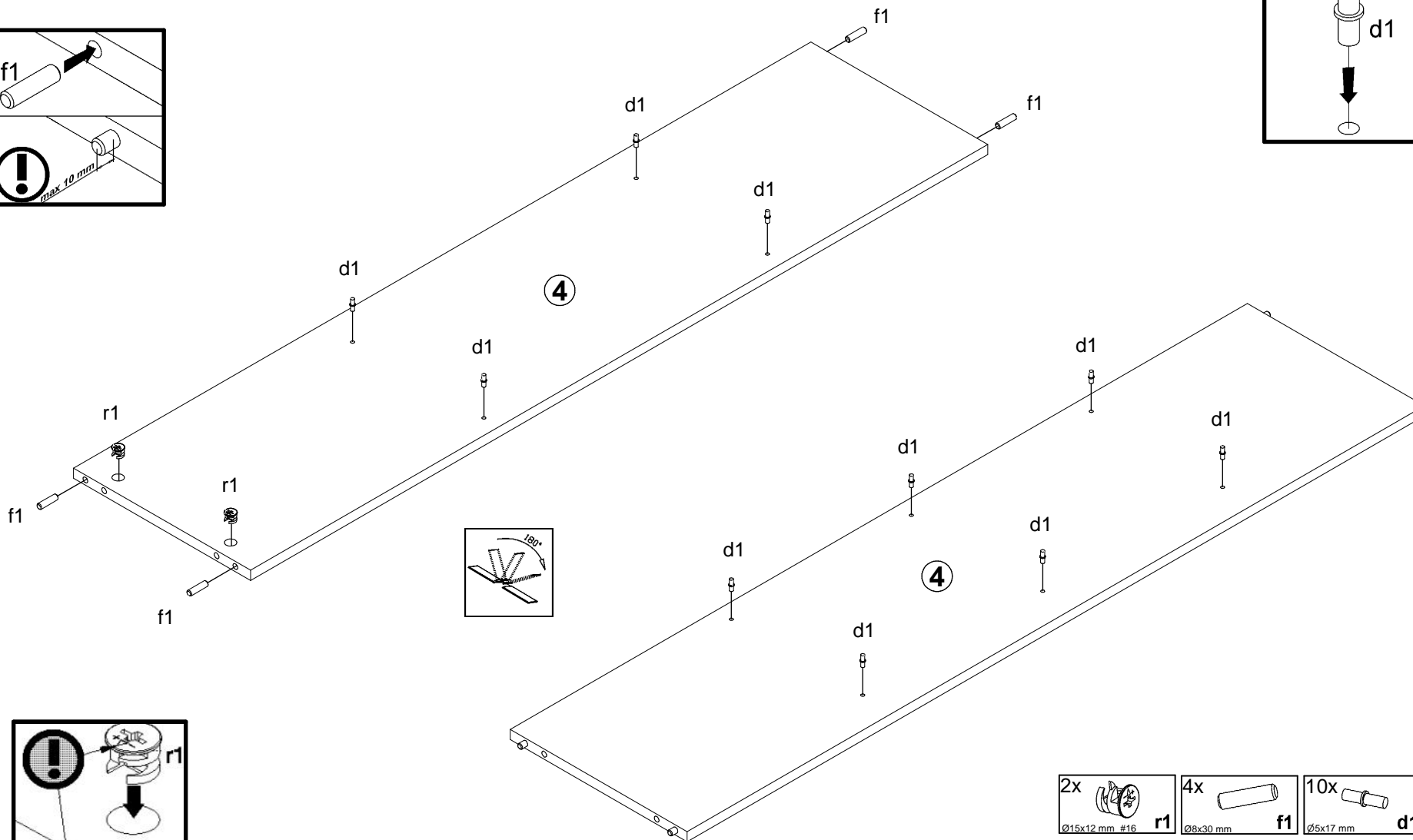
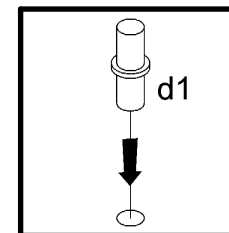
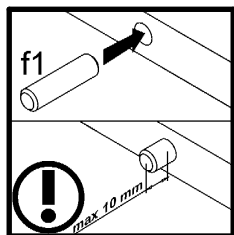

- 2x r1 $\varnothing 15 \times 12 \text{ mm} \# 16$
- 4x f1 $\varnothing 8 \times 30 \text{ mm}$
- 10x d1 $\varnothing 5 \times 17 \text{ mm}$

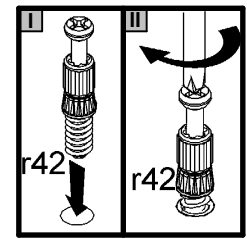
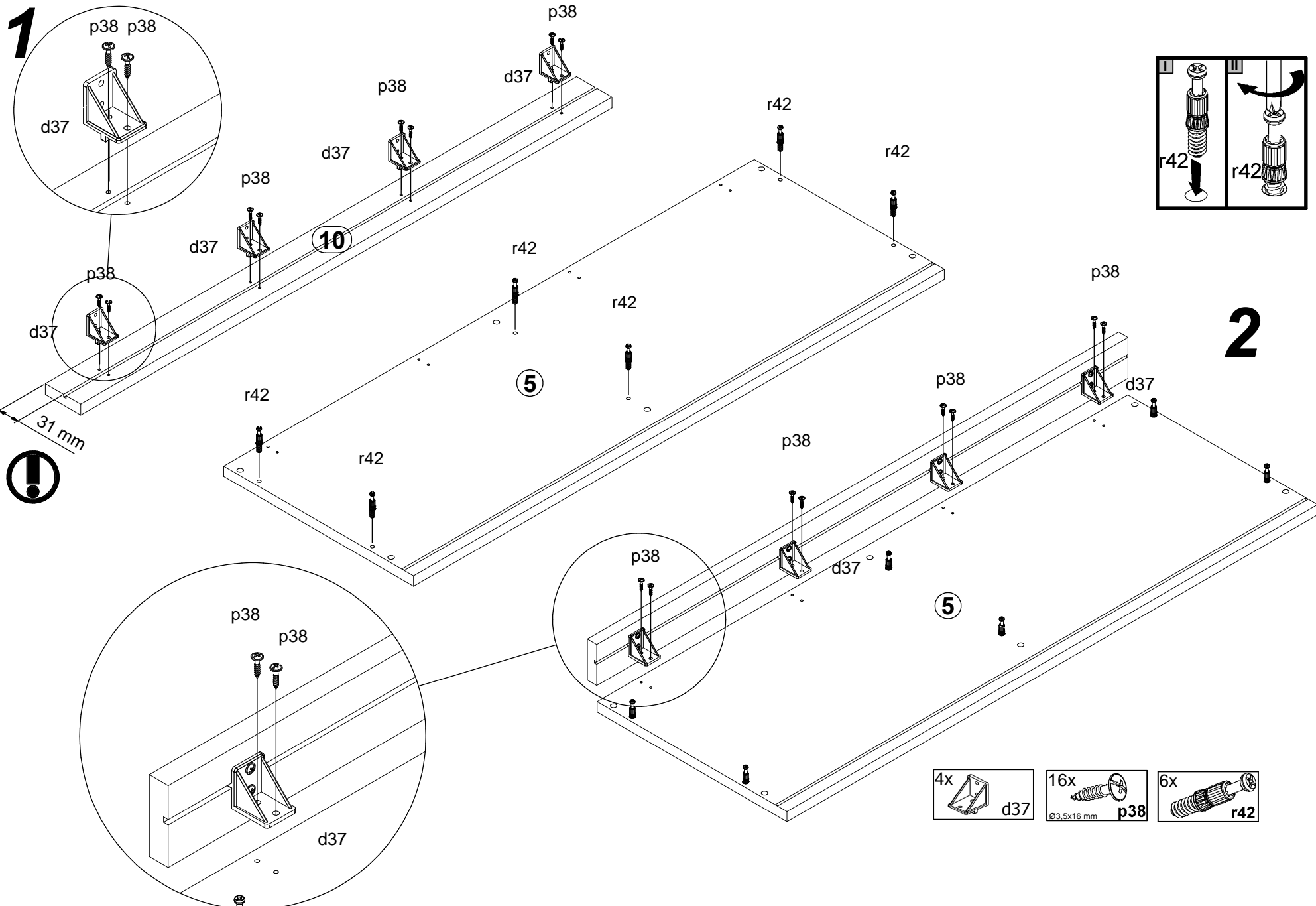

- 4x d37
- 16x Ø3,5x16 mm p38
- 6x r42

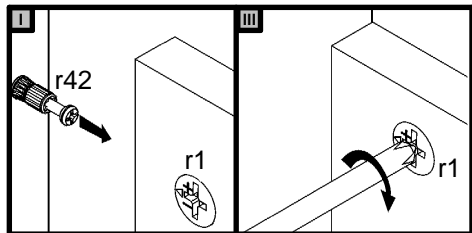

4

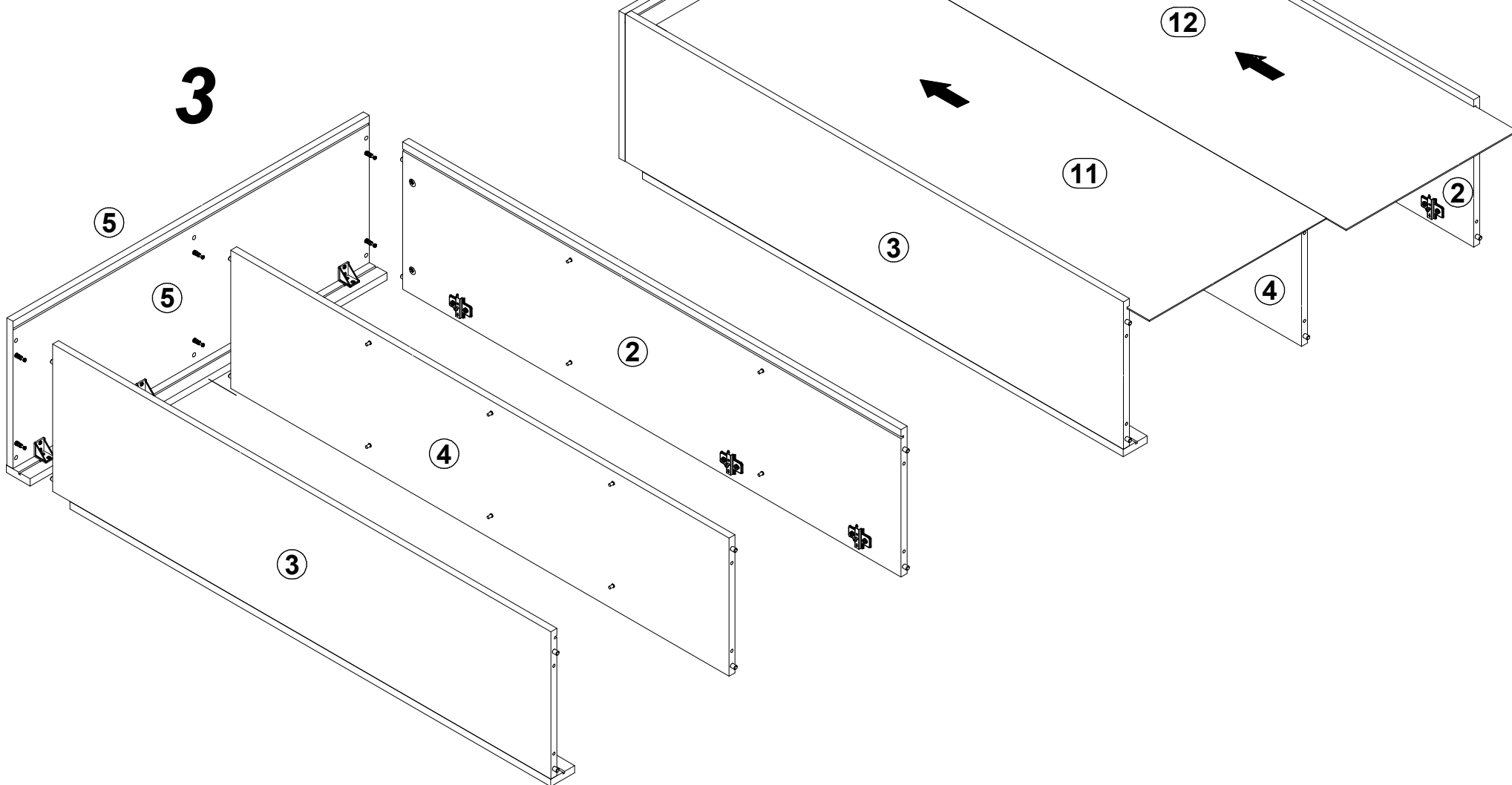



6

5

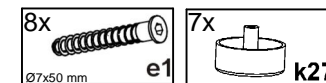
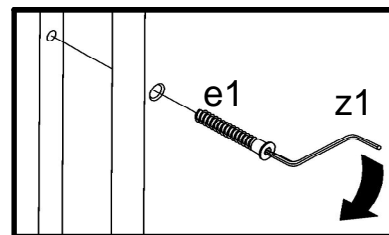
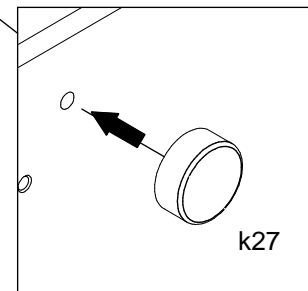
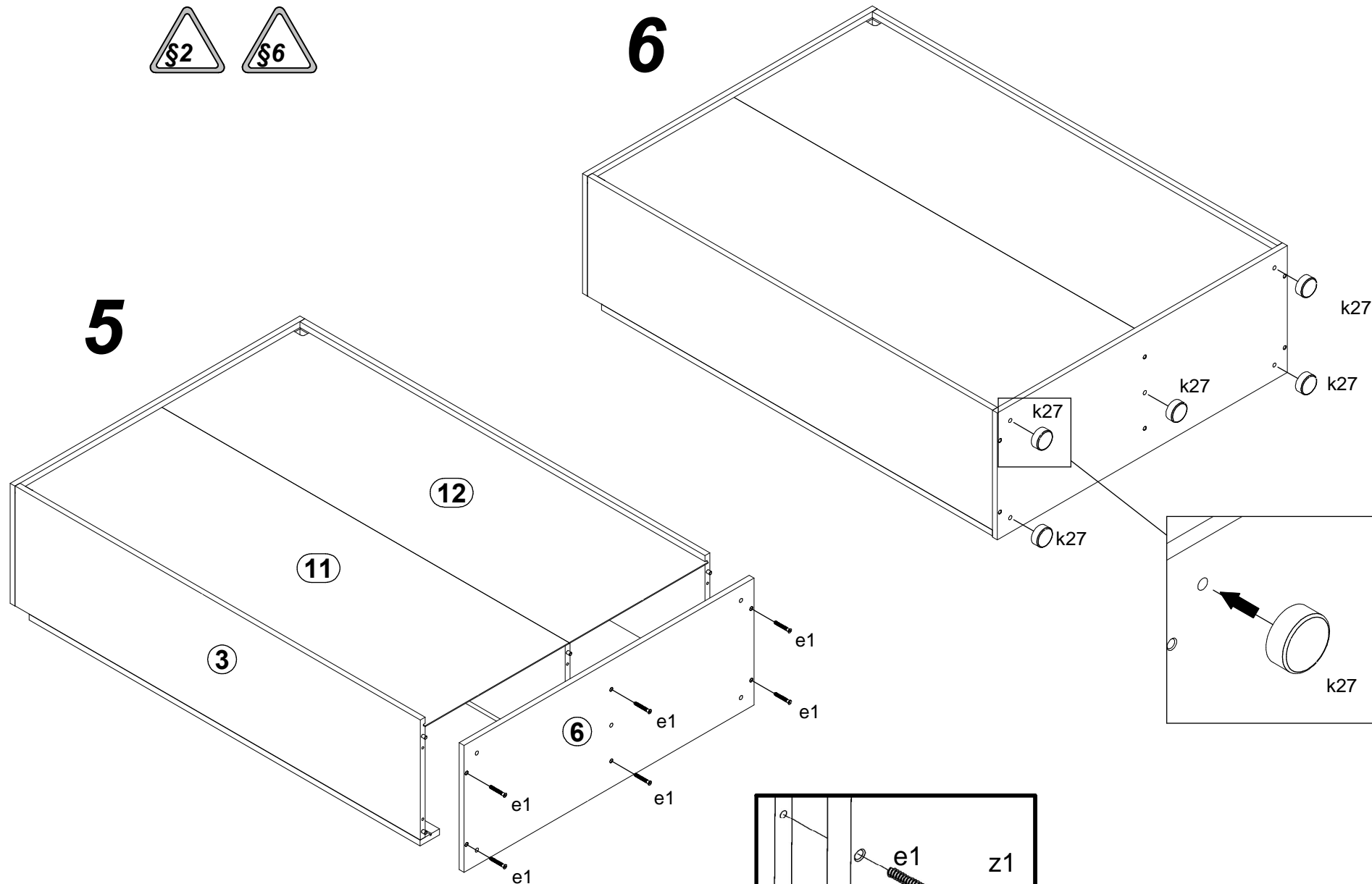

7

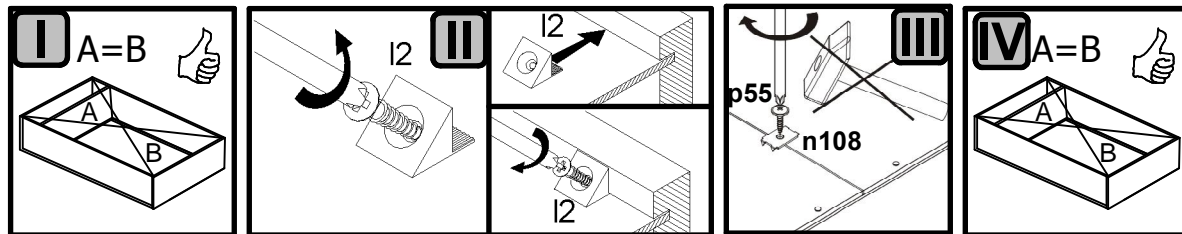

8

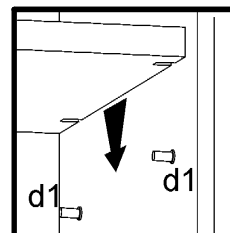
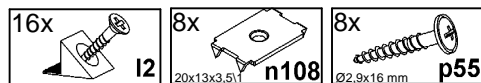
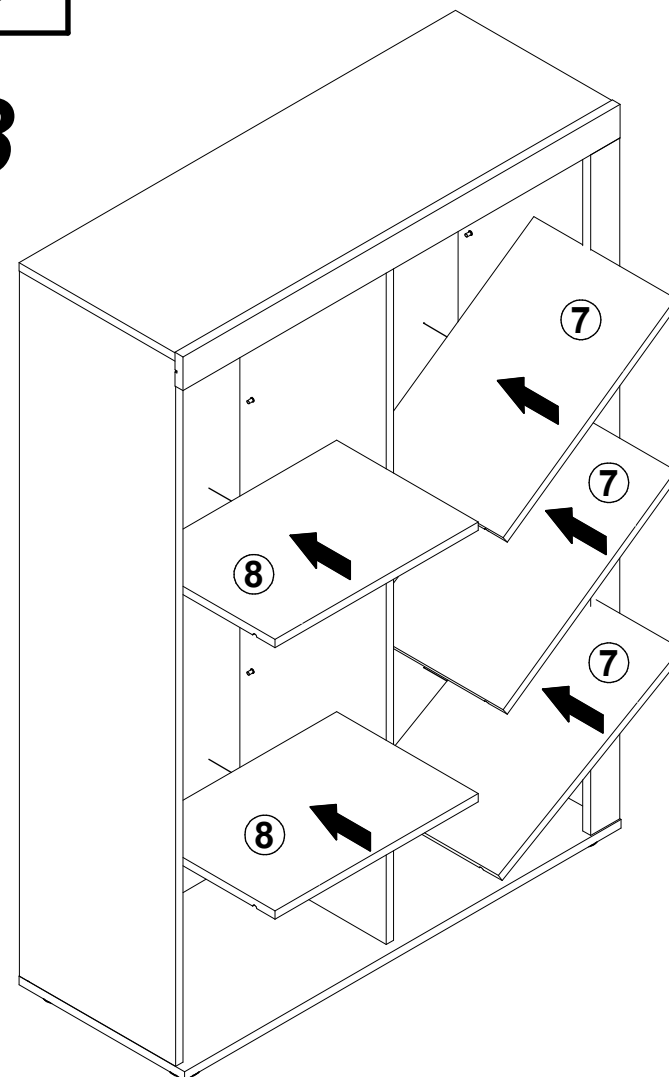
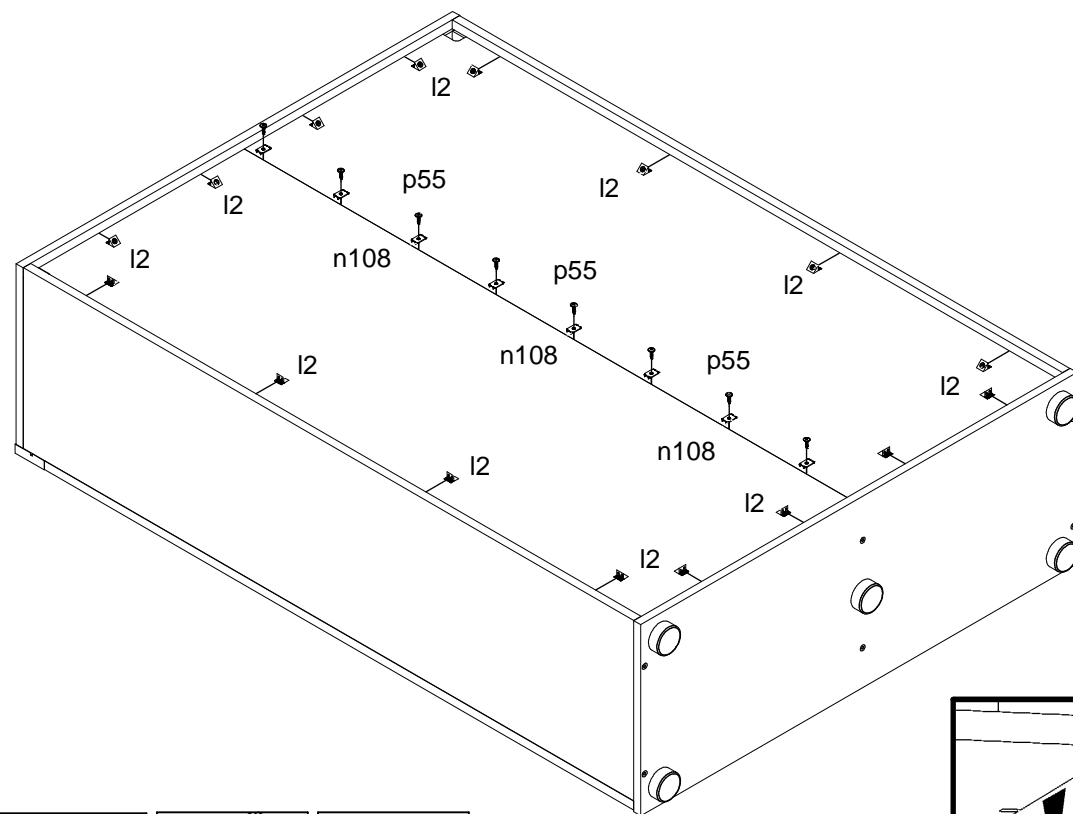

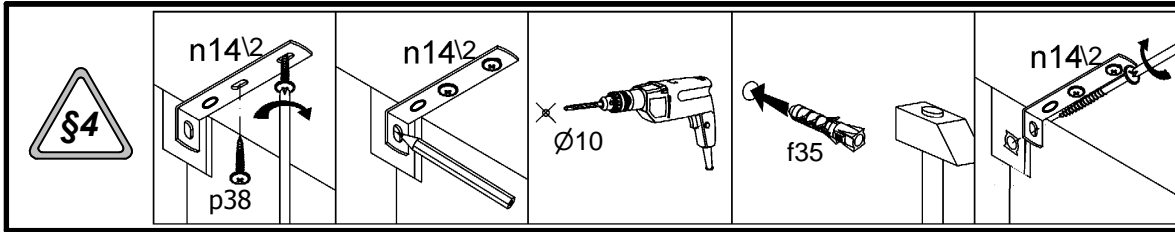

9

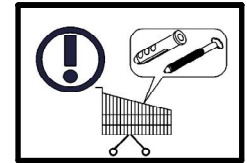
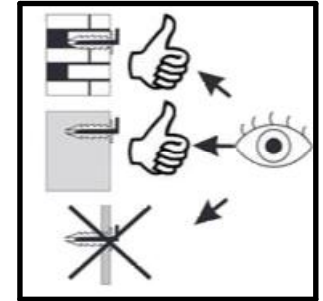
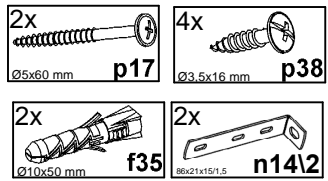
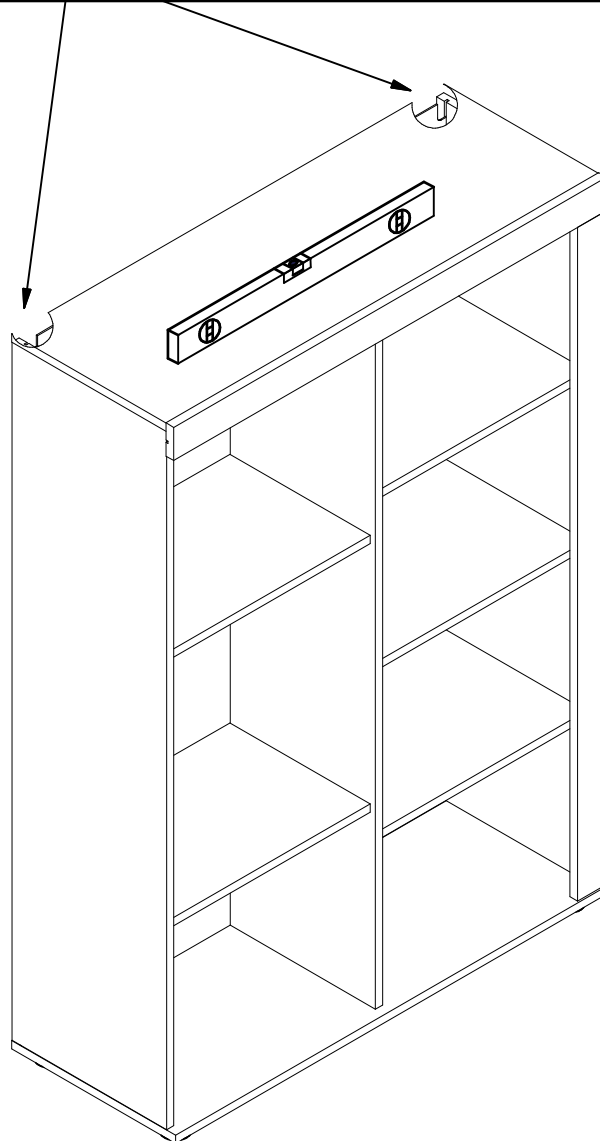
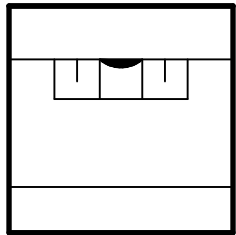

10

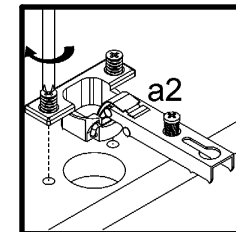
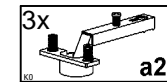
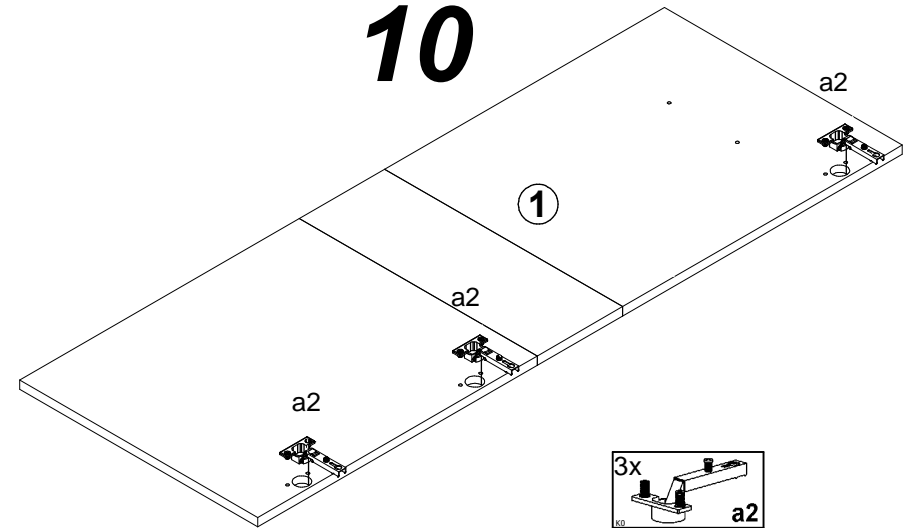

11

