

980225

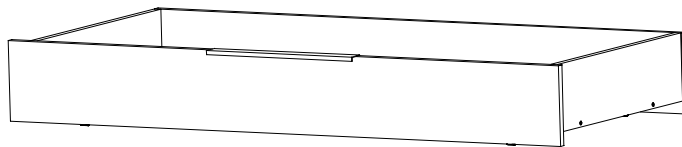

FR

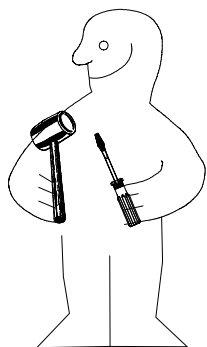
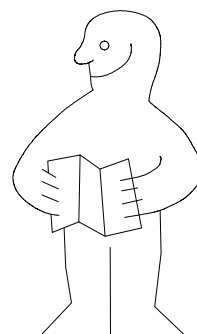
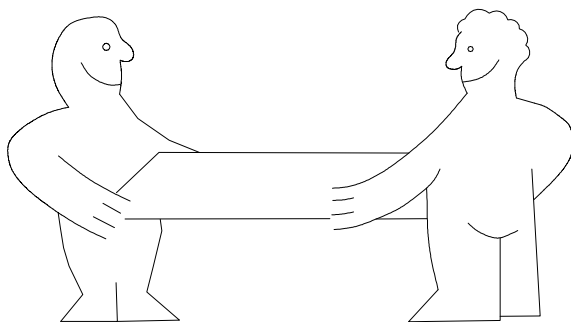
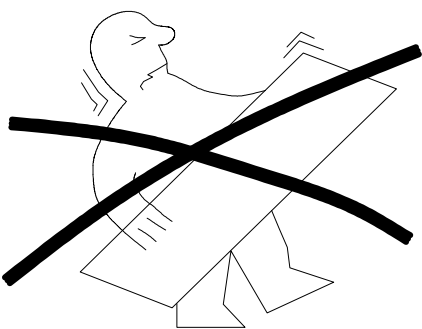

1-2-3-4...

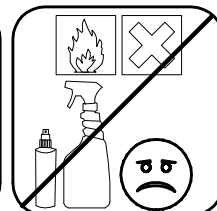
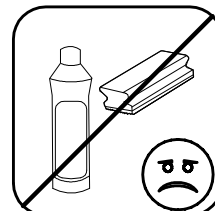
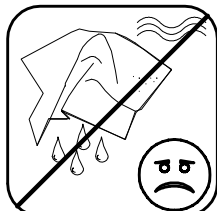
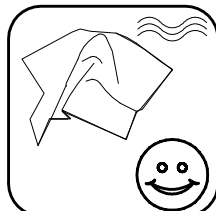
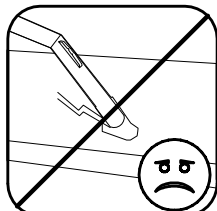
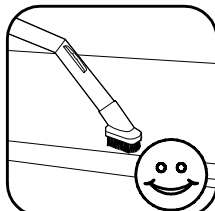
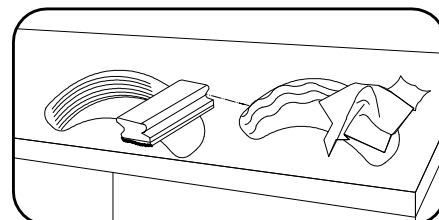
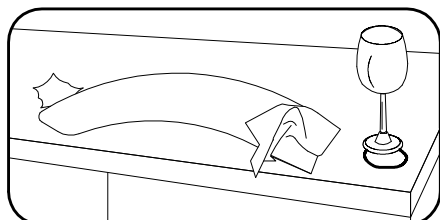
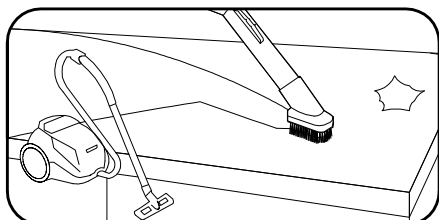
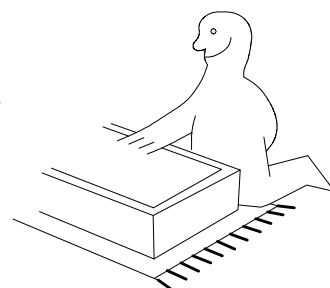
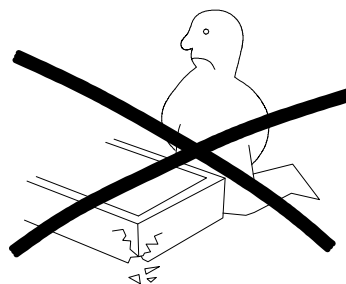
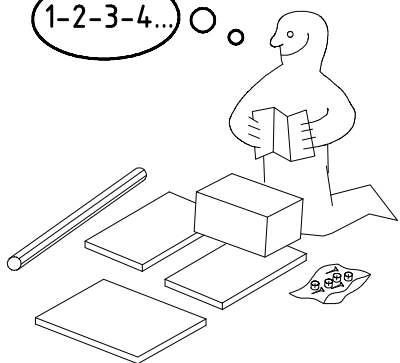

980225

24.05.12 / 21.06.13

06 13

1/4

U
111 066/074
4 X

Z
163 007
4 X 23 mm
SP23
121117
8 X

D
353 018 $\phi 8 \times 30$
8 X

B
111 609
4 X

KR
4 X

SP15
4 X 15mm
121 120
8 X

A
111 102
4 X

C
111 103
4 X

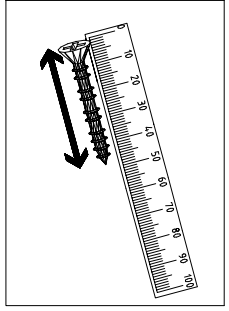
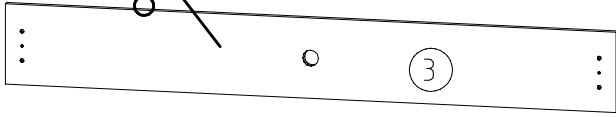
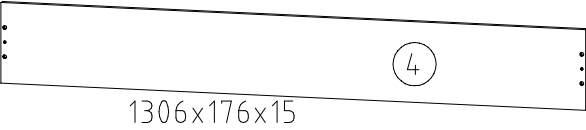
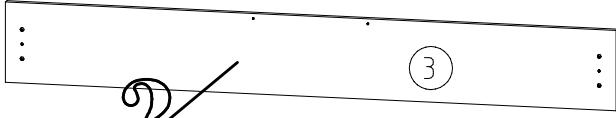
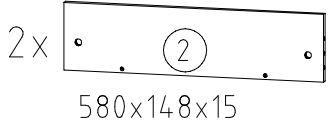
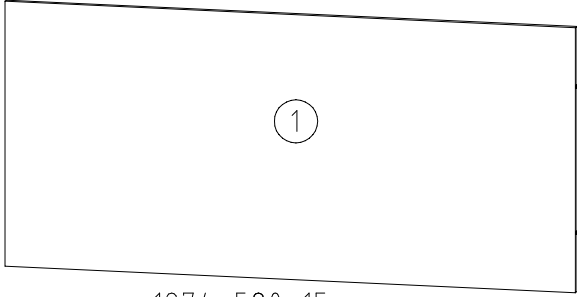
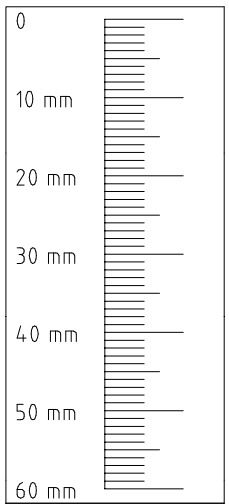
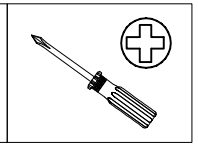
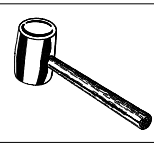
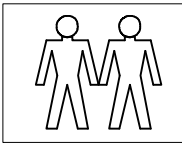

1

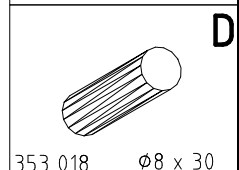
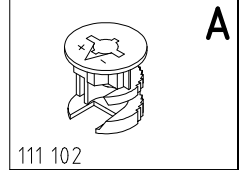
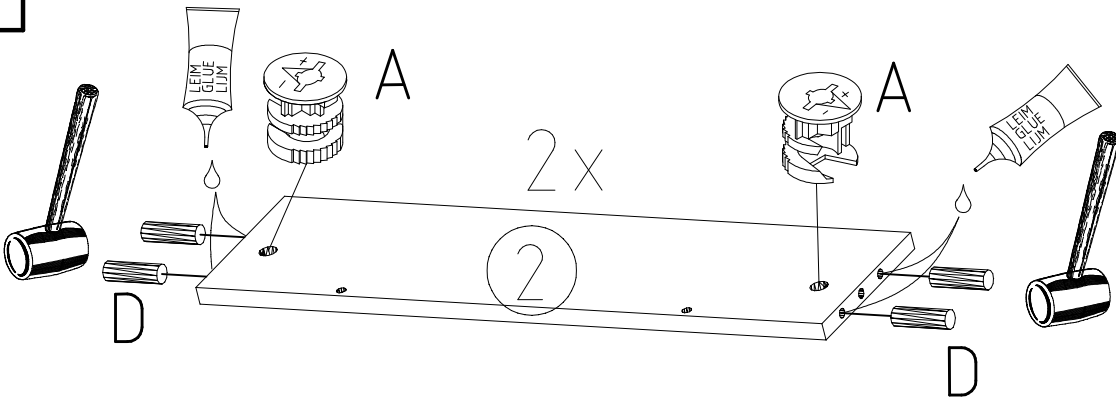

2

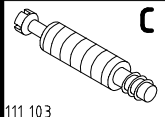
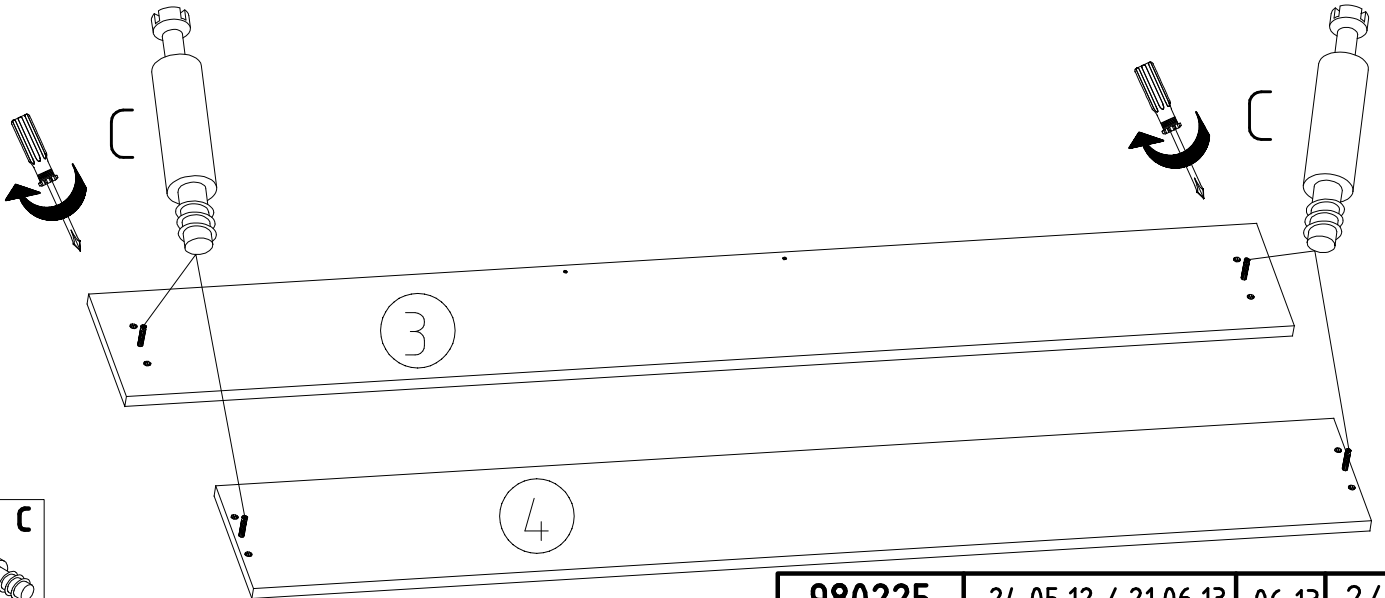

4

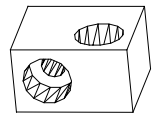
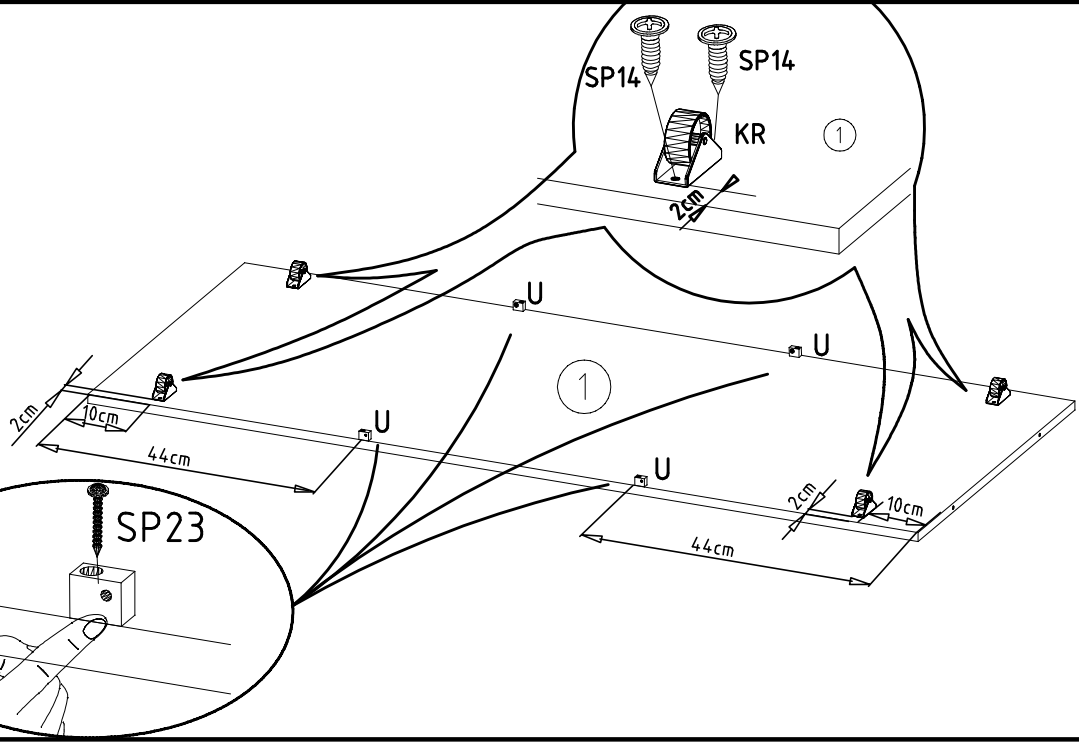

111 066/074
4 X 23 mm **SP23**

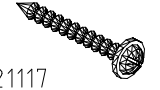

121117

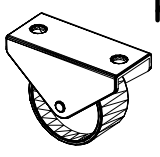

KR



4 X 15mm **SP15**
121 120

5

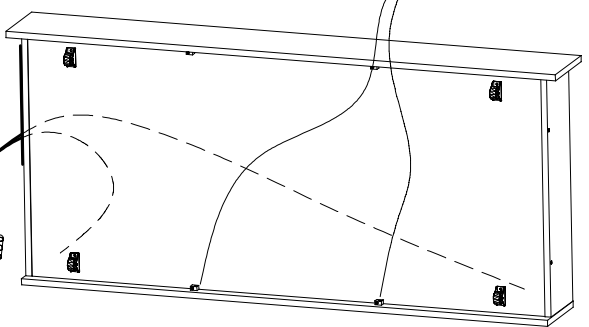
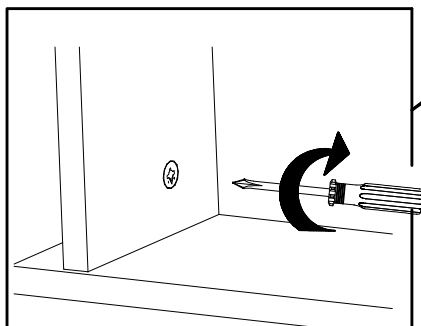
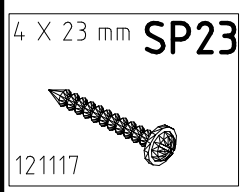
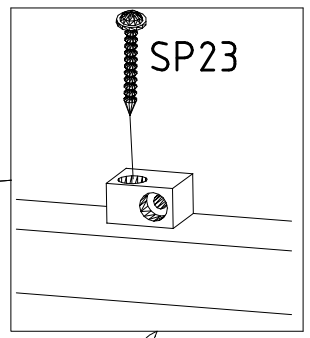
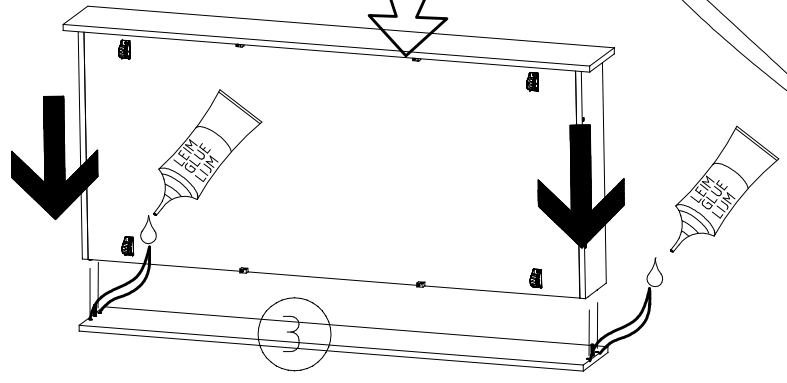
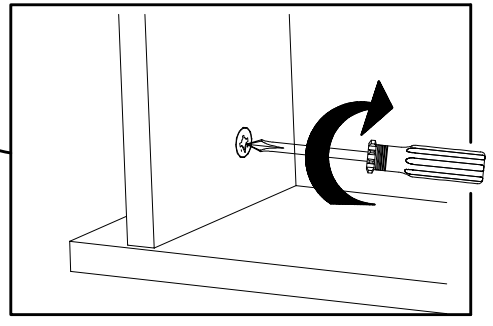
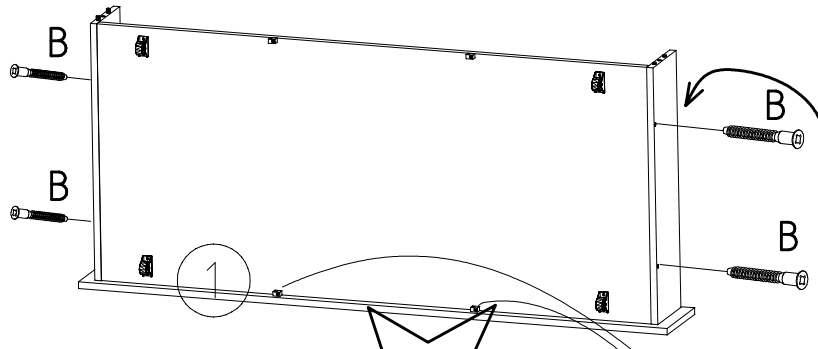
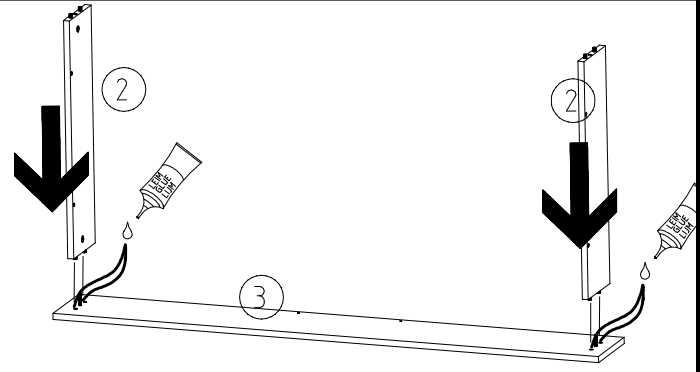
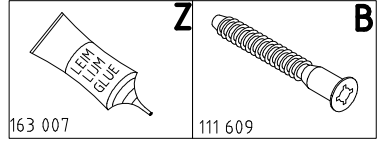

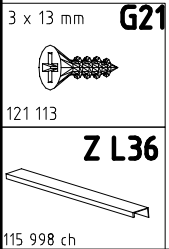
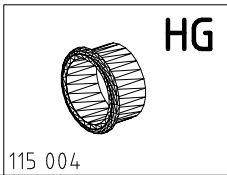
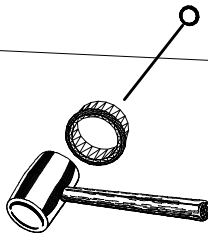
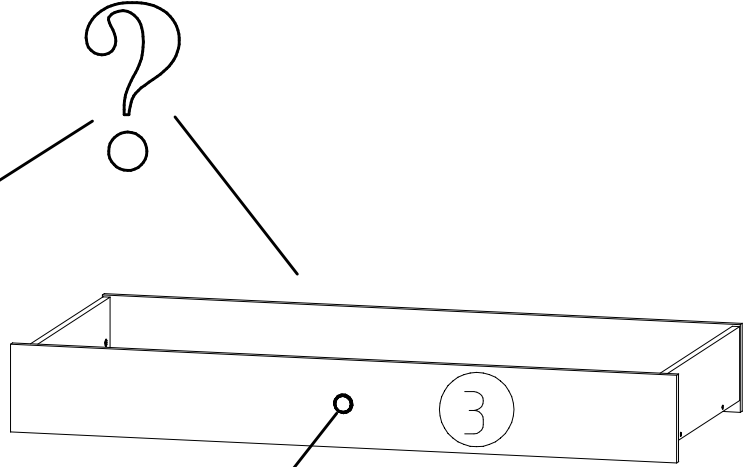
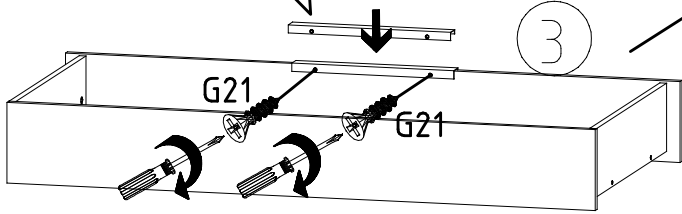
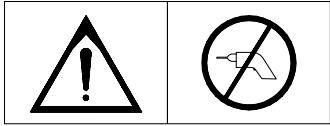

Modell/Model/Modèle

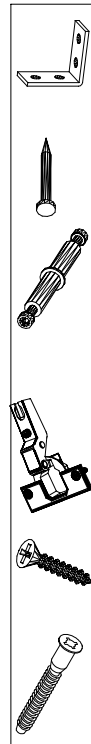

| | | |
|-----------|---------|------|
| <121 370> | < G 1 > | <4x> |
| | | |
| | | |
| | | |
| | | |

Änderungen die dem technischen Fortschritt geschuldet sind behalten wir uns vor!
 Bei nicht vorschriftsmäßiger und/ oder nicht fachmännischer Montage wird bei Personen- und/ oder Sachschäden keinerlei Haftung übernommen.
 WIMEX Wohnbedarf/ Import Export Handels GmbH/ Postfach 14.07/ 49112 Georgsmarienhütte/ Germany
 Tel.:(+49) 054.01.85.98 16/17 Fax.:(+49) 054.01.85.98 33 Mail: info@wimex-wohnbedarf.de