

# TTX02

1558-001-01 

# 01

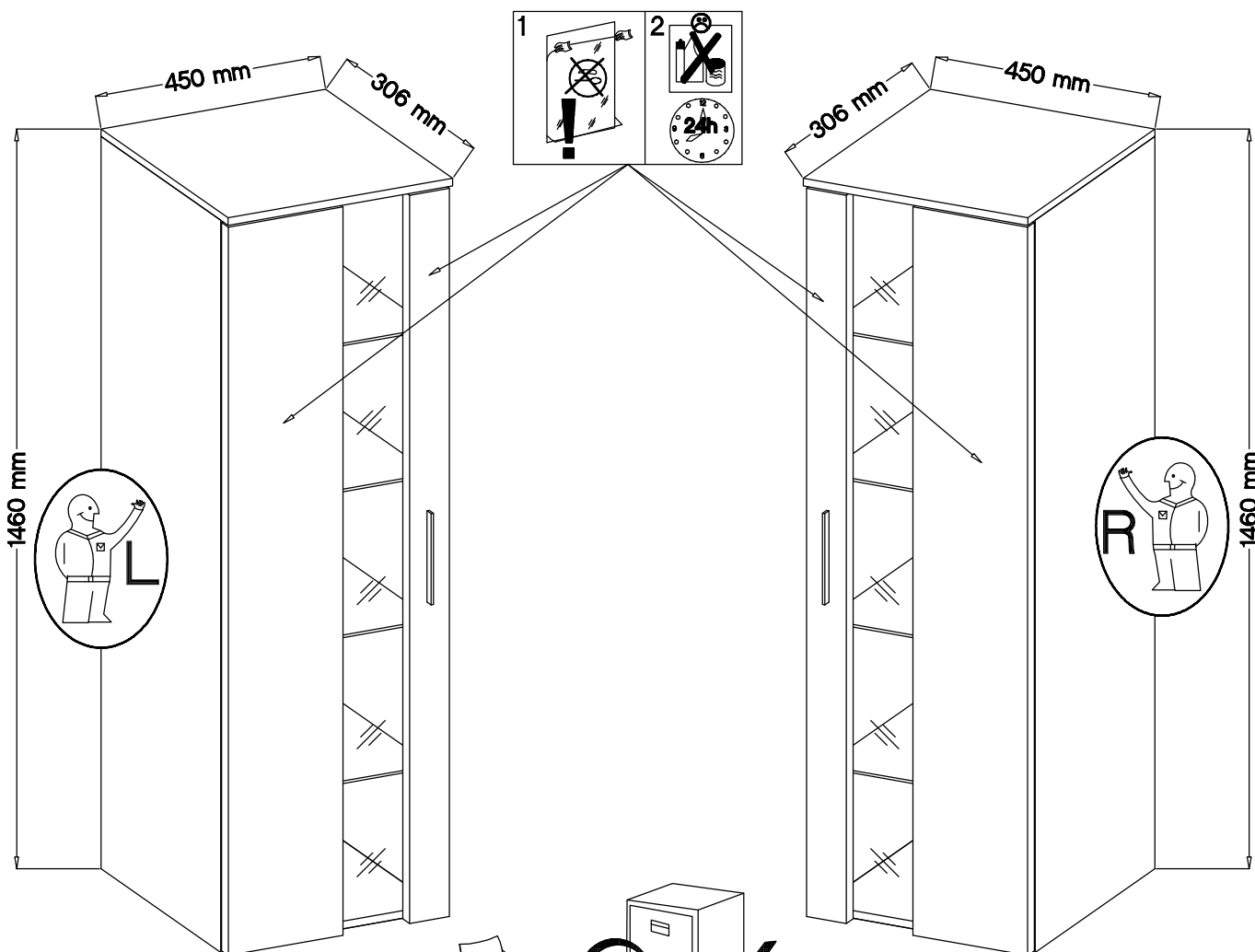
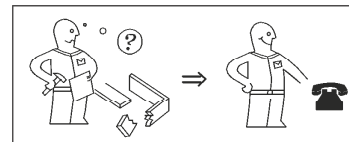
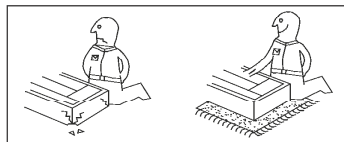
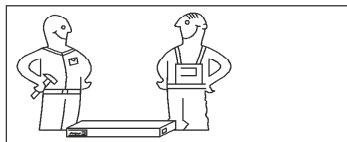

C1	1	7
	2	4
	3 x2	8 x8
	4 x2	
	10 x2	

C2	5 x2
	6 x2
	11
	12
	9 x2

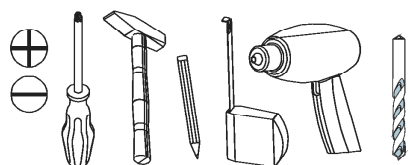
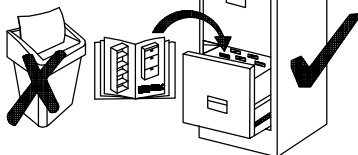

festziehen / tighten / Затягивать / serrer / stringere / utáhnout / vasttrekken / zategnuti / strängere / zwiazać / zacisnąć szorosan meghúzni / pevno dotiahnut / trdno pritegniti / затянуть / dra át / fíjar / Sıkın



eindrücken / press in / enfoncer / wcisnąć / strągnąć / zatáčit / вкaрайте / indrukken / beşnyomni / stlačit / vtišniti / tryk in / introducere prin apăşare / вдавить / empujar / çeri bastırın



ausmessen / measure / măsurer / măsurare / ormeten / izmeriti / miara / kimérni / izmeriti / măsurare / измерить / změřit / Измерете / mät upp / zmierzyc / medir / Ölçün



drücken / press / presser / stisknout / Натиснете / vtišniti / nasinac / drukken / pritisnuti / nacisnac / pritisniti / нажать / (meg)nyomni / apăşare / tryck fast / nacisnąć / presionar / Bastırın



einschlagen / hammer in / beverni / sla in / frapper au marteau / infossare / Zabit / zarazit / Набейте / zabiti / wbić / introducere prin bataie / забить / zatout / clavare / çeri vurun



Drehen - wenden / przekreć - odwrócić / Keren - omđraalen / Girare - Ruotare / Okrenuti - ubrnuti / Retourner - renversar / Turn over - turn around / Otoćte - obratite / Завертете - обърнете / Obrnite list / Inbarceşti - rotiş / Vrid runt - vänd / прокрутите - повернуть / otočit - obrátit / elforgathi - megfordítani / Girar / Çevirin

# TTX02

1558-001-01

# 01

**D** Unser Direktservice für Beschlagteile  
Sollte Ihnen ein Beschlagteil fehlen, können Sie diese Servicekarte direkt an die untenstehende Adresse mailen. Wir können allerdings nur Beschlagteile auf diesem Wege verschicken. Sollten Sie eine andere Beanspruchung an Ihrem Möbestück haben, so wenden Sie sich bitte direkt an Ihr Möbelhaus.

**GB** Our direct order service for fitting  
If a fitting part is missing, you can e-mail this service card directly to the address below. However, we can only send fitting parts in this way. If you have any other cause for complaint concerning your item of furniture, please contact your furniture store directly.

**CZ** Naše přímé službu pro kování  
Chybí li vám nějaký díl z kování, můžete tuto servisní kartu odeslat e-mailem přímo na níže uvedenou adresu. Touto cestou však můžeme zoslat jen díly kování. Pokud byste reklamovali jiný díl nábytku, obraťte se přímo na svého prodejce nábytku.

**F** Bien étudier la notice de montage  
S'il vous manque une ferrure, veuillez envoyer directement la présente carte service à l'adresse e-mail indiquée ci-dessous. Cependant, ceci nous permet uniquement d'envoyer des ferrures. Pour tout autre type de réclamation concernant votre meuble, veuillez contacter directement votre magasin d'ameublement.

**I** Il nostro servizio diretto per l'ordine della ferramenta  
Qualora Vi dovesse mancare un pezzo di fissaggio, allora Vi preghiamo di inviare questa carta di servizio immediatamente all'indirizzo sottostante. Possiamo inviare i pezzi di fissaggio solamente per mezzo di questo procedimento. Qualora dovete avere qualche altra reclamazione in merito al mobile, allora Vi preghiamo di rivolgerVi direttamente al Vostro Negozio di mobili.

**BG** Цялата директна услуга за обков  
Ако липсват части от комплекта, попълнете настоящата сервисна карта и ни я изпратете на е-мил адреса, посочен по-долу. По този начин можем да доставим само липсващи елементи от обкова. Ако установите други дефекти по мебелите, Ви съветваме да се обърнете към мебелната къща/магазин, от който сте закупили стоката.

**NL** Onze directservice voor losse onderdelen  
Wanneer er een onderdeel ontbreekt, kunt u deze servicekaart direct aan onderstaand e-mailadres sturen. Wij kunnen langs deze weg echter alleen losgedeelde versturen. Mocht u een ander probleem aan uw meubel hebben, verzoeken wij u contact op te nemen met uw meubeldealer.

**PL** Nasz bezpośredni serwis części montażowych  
Jeżeli brakuje części koniecznych do montażu, prosimy o przesłanie nam niniejszej karty serwisowej na niżej podany adres e-mailowy. W ten sposób możemy przelać Państwu tylko brakujące części. W przypadku innych reklamacji dotyczących mebla, prosimy zgłosić się do salonu meblowego, w którym został dokonany zakup.

**HR** Servis za okove  
U slučaju da nedostaje neki od dijelova molimo vas da na dolje navedenu mail adresu pošaljete ovaj servisni obrazac. Na ovaj način mogu se dostaviti samo okovi. U slučaju da imate dodatne prigovore vezane uz komad namještaja molimo vas da se obratite izravno trgovini namještaja odjije je isti kupljen.

**HU** Direktszolgáltatunk vasalatók esetén  
Ha hiányzik egy vasalat, ezt a kártyát közvetlenül elküldheti az alább található címre. Azonban csak vasalatókat tudunk így küldeni. Amennyiben más tárgyat reklamálna, akkor a boltot kell megkeresnie, ahol a bútort vásárolta.

**SK** Naše priamy servis pre časti kovania  
Ak by Vám chýbala nejaká časť kovania, môžete poslať túto servisnú kartu poslať e-mailom na nižšie uvedení adresu. Diely kovania vieme poslať iba týmto spôsobom. Ak by ste mali inú reklamáciu ohľadom Vášho nábytku, obráťte sa priamo na Vašu predajňu nábytku.

**SLO** Naše direktne uslužne storitve za okovje  
Če vam manjka kakšno okovje, lahko to servisno kartico pošljete po e-pošti direktno na spodnji naslov. Po tej poti vam lahko pošljemo samo okovje. Če želite reklamirati kakšen drug del pohištva, se obrnite neposredno na vašo trgovino pohištva.

**RO** Serviciul nostru direct pentru feronerie  
In cazul in care va lipseste o piesa de feronerie puteti sa trimiteți direct acest card de service prin e-mail la adresa de mai jos. Noi nu putem expedia piese de feronerie decât pe această cale. Dacă aveți o altă reclamație referitoare la piesa de mobilier, atunci vă rugăm să vă adresați direct la magazinul dvs. de mobilă.

**RUS** Наш прямой сервис для поставок фурнитуры  
Если окажется, что Вам не хватает того или иного элемента фурнитуры, Вы можете отправить сервисную карту по факсу непосредственно на нижеприведенный адрес электронной почты. Однако, таким образом мы можем поставлять лишь фурнитуру. Если же у Вас возникнут иные претензии относительно приобретенной мебели, пожалуйста, обращайтесь непосредственно в организацию, осуществившую продажу.

**S** Vår direktservice för beslagsdelar  
Om du saknar en beslagsdel kan du skicka detta servicekort direkt till e-postadressen som anges nedan. Tänk på att detta är den enda möjligheten att skicka beslagsdelar till dig. Om du vill reklamera din möbel av en annan anledning måste du kontakta ditt möbelhus direkt.

**ES** Nuestro servicio directo para accesorios  
Si le falta algún accesorio, puede enviar esta tarjeta de servicio directamente a la siguiente dirección. No obstante, por este método solo podemos enviar accesorios. Si tiene alguna otra objeción sobre su mueble, consulte directamente con su mueblería.

**TR** Donatılar için doğrudan servisimiz  
Bir donatınız eksikse bu servis kartını doğrudan aşağıda bulunan adrese doğrudan mail yazabilirsiniz. Sadece bu yolla donatılar gönderilebilir. Mobilyanızın başka şikayetleriniz varsa lütfen doğrudan mobilya satıcınıza danışın.

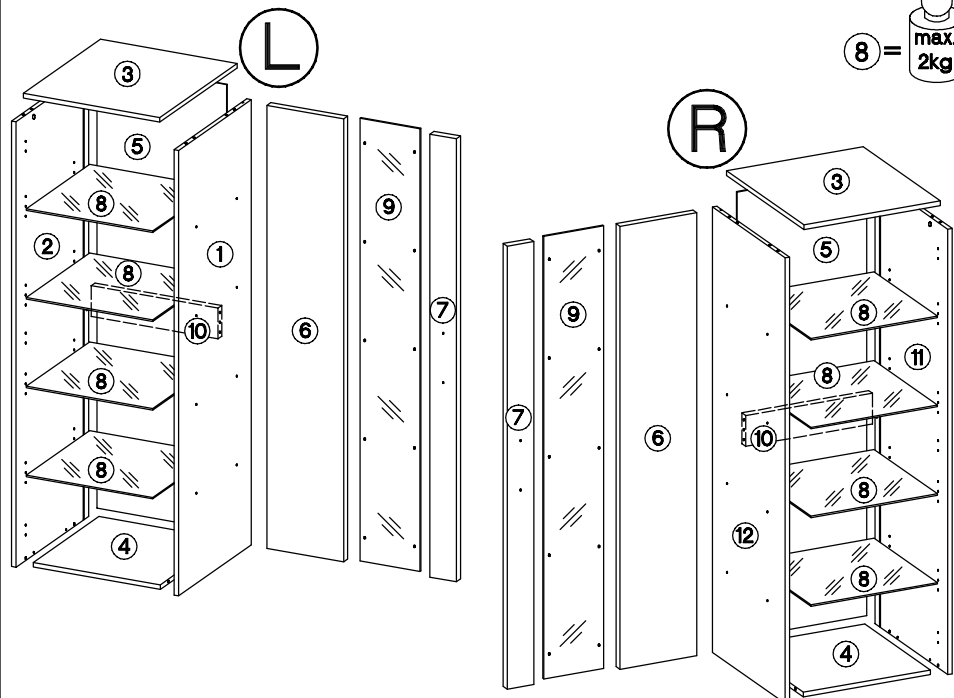

8 = max. 2kg

**2B** : 

$\pm 35/0mm$	H-2	$\pm 3.5x13mm$
G	H4	P5
6	6	12

**3B** : 

L-160mm
S3
2

$4.0x16mm$	$\pm 7/4mm$	$\pm 5.0x60mm$	$\pm 3.5x13mm$	$\pm 4.0x27mm$	$\pm 20/25$
R11	J7	P12	P5	R1	J12
20	20	2	4	4	32
L-20mm	$\pm 15/12mm$	$\pm 8x30mm$	L	E	$\pm 3.0x20mm$
<b>1B</b>	D2	C	A	L	E
36	20	24	14	16	8
					P7
					O7
					L19
					2
					2

LKZ 80106

Grund der Beanstandung / Reason of the objection:

---

Möbelhaus / Furniture store:

Name / Name:  Telefon / Telephone:

PLZ / postal code:  Ort / City:

Strasse / Street:

Haus-Nr. / House No.:  @E-Mail:

# 1

L=20mm D2 36	#5/12mm C 20	#8x30mm A 24
--------------------	--------------------	--------------------

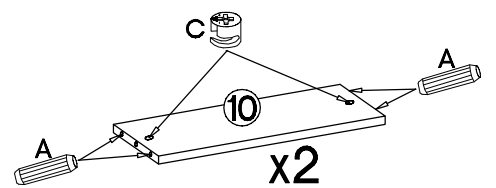
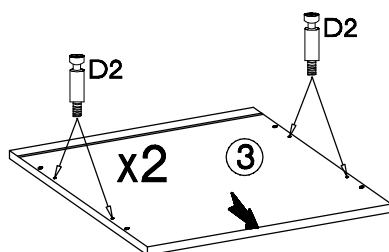
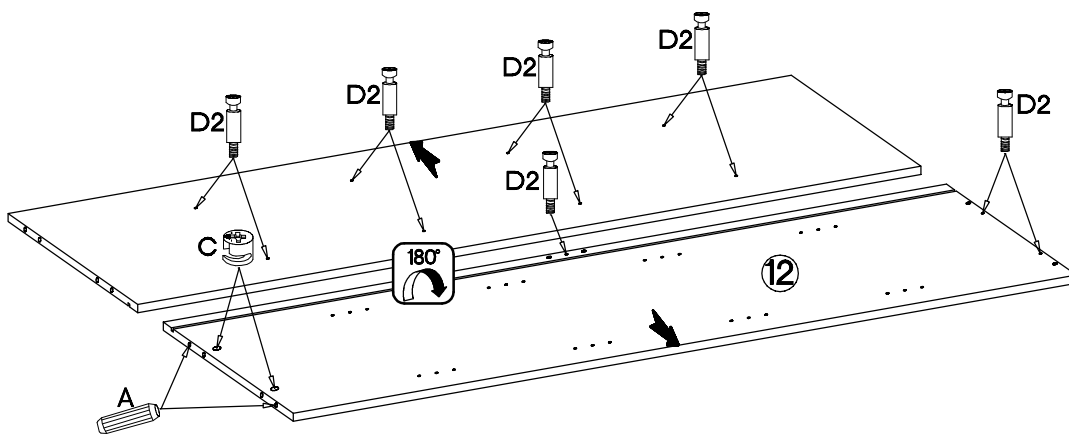
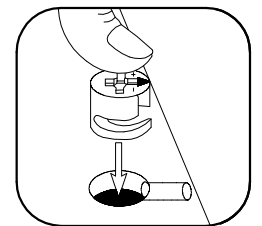
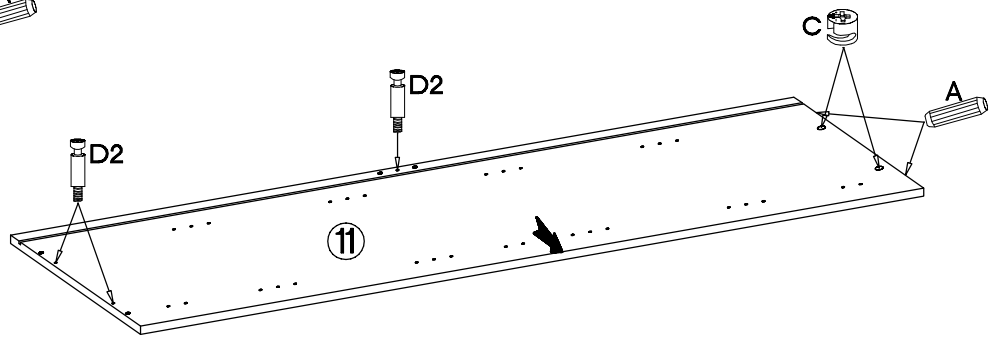
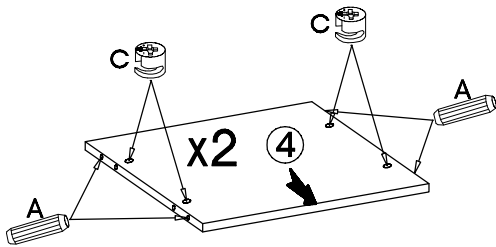
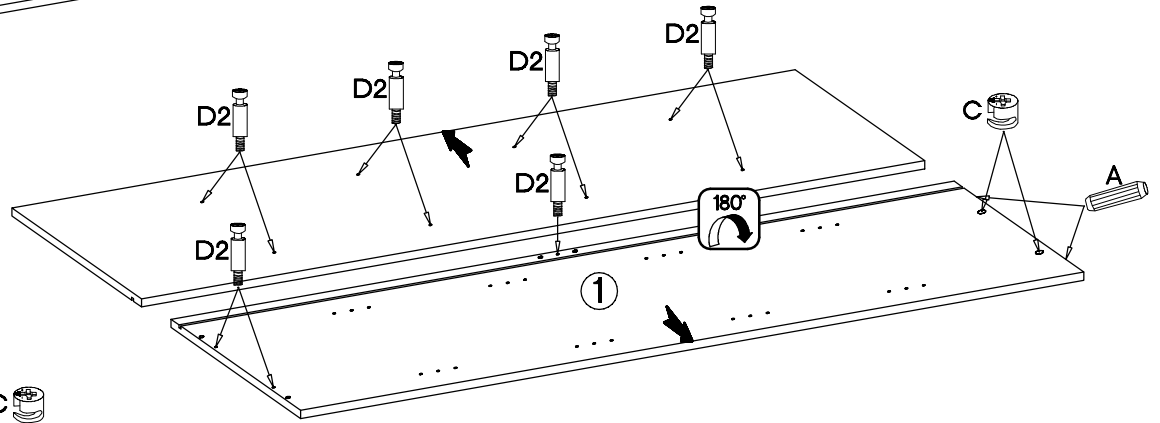
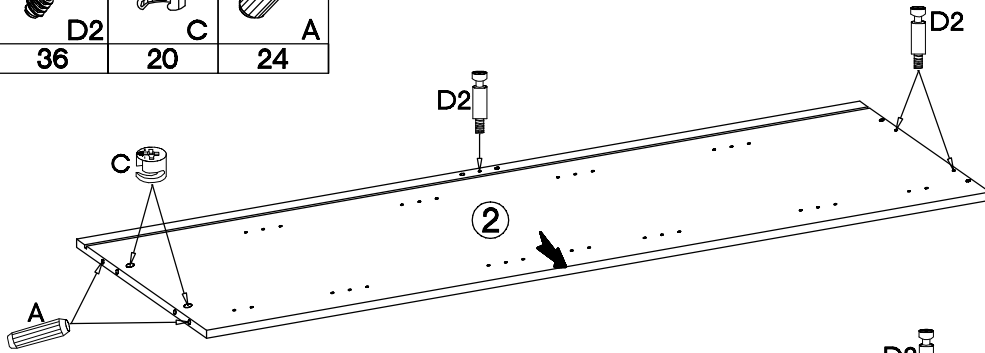
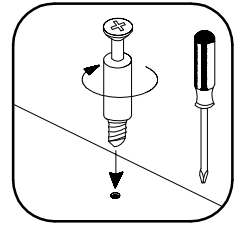

2

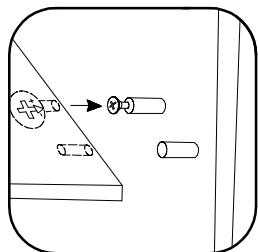
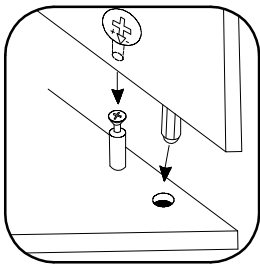
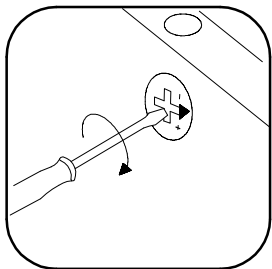
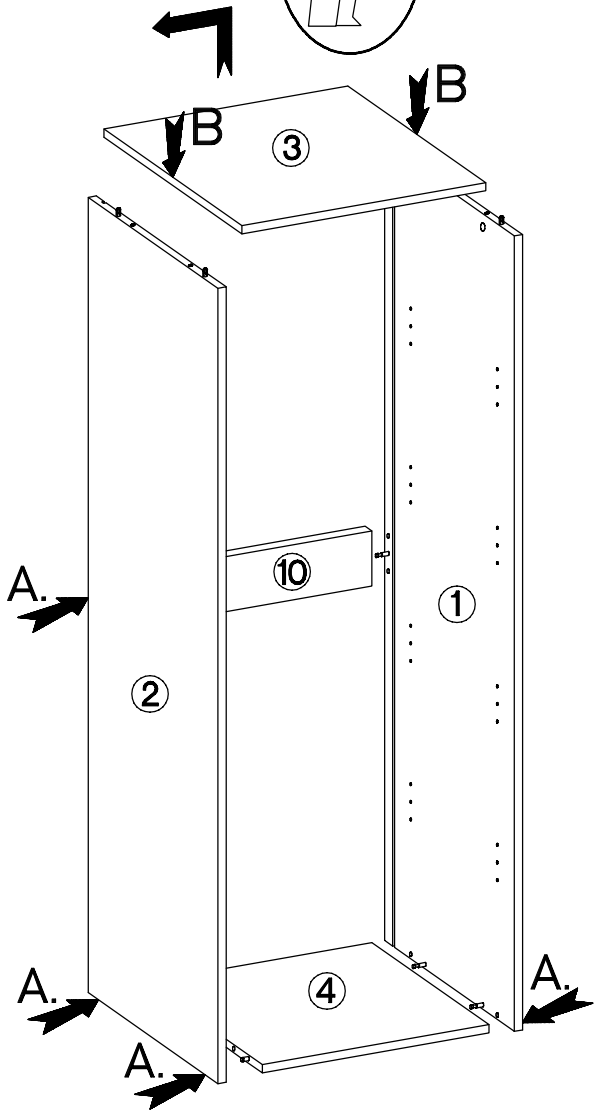
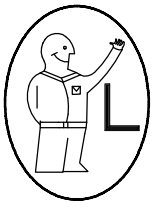

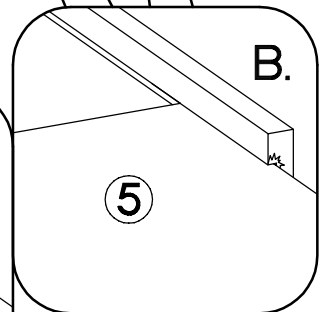
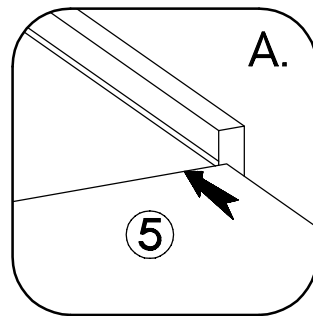
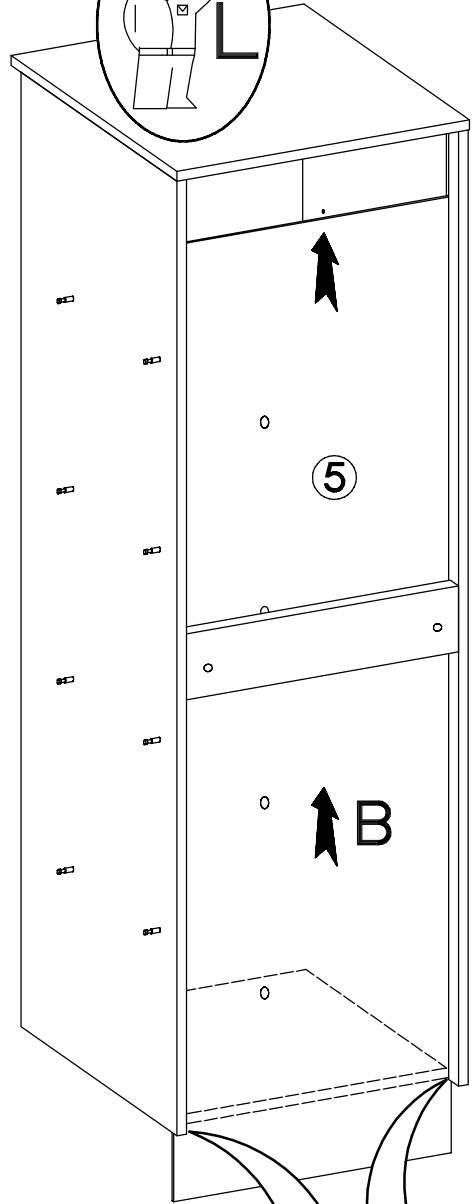
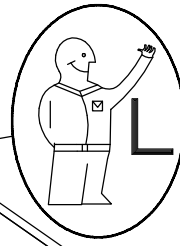

3

A



4

3.0x20mm		
	P7	L
4		7

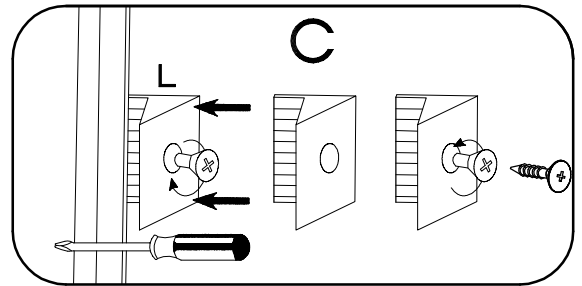
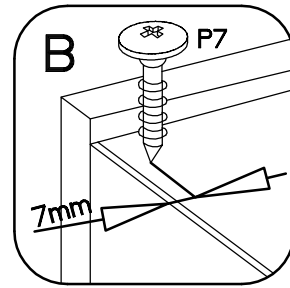
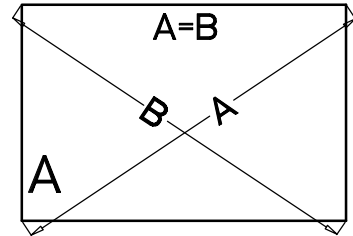
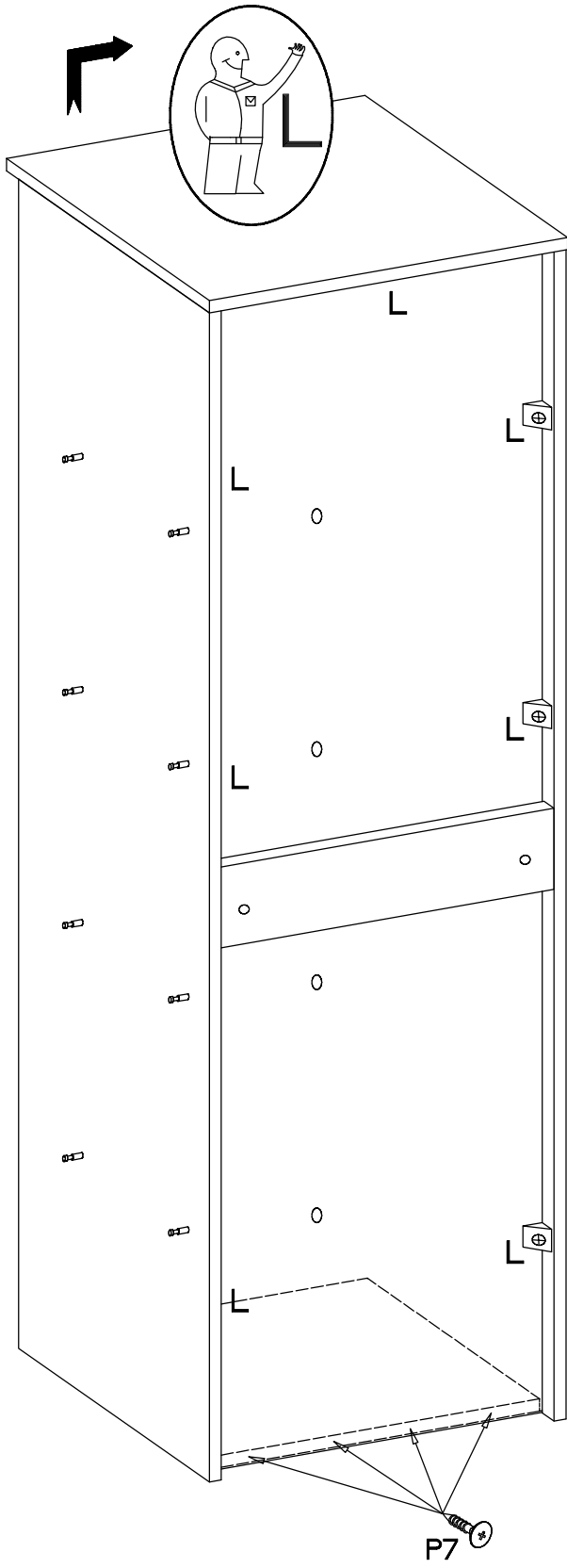

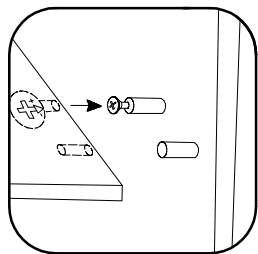
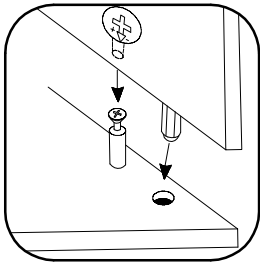
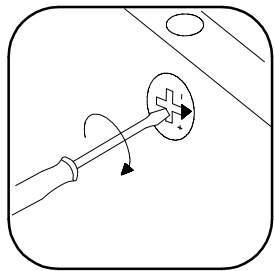
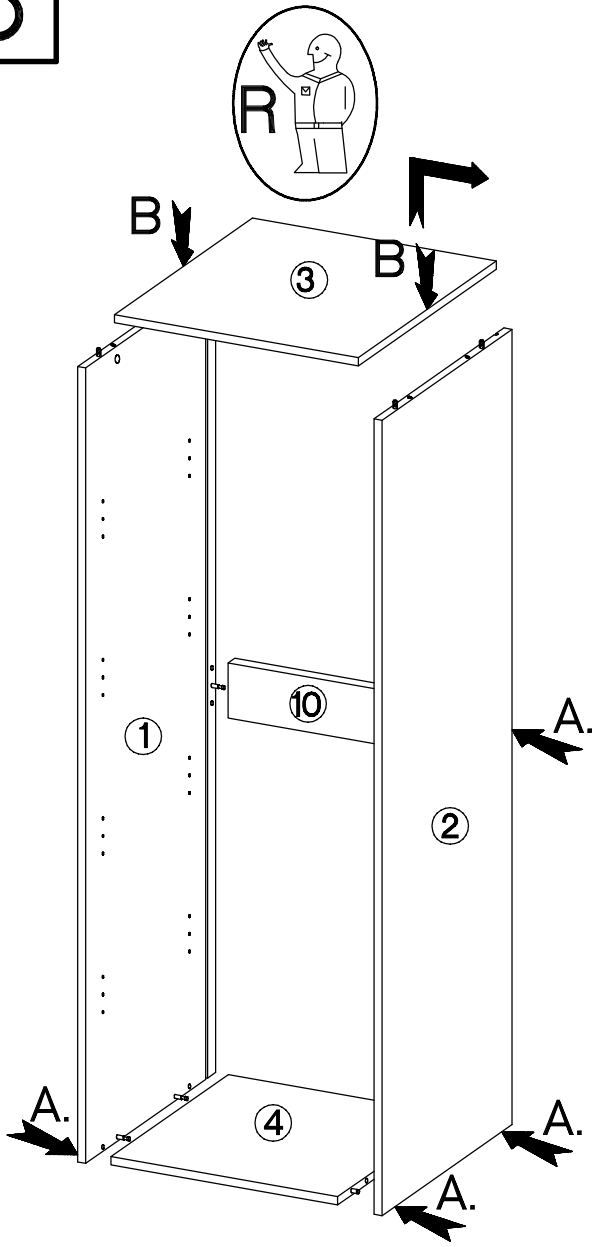

5

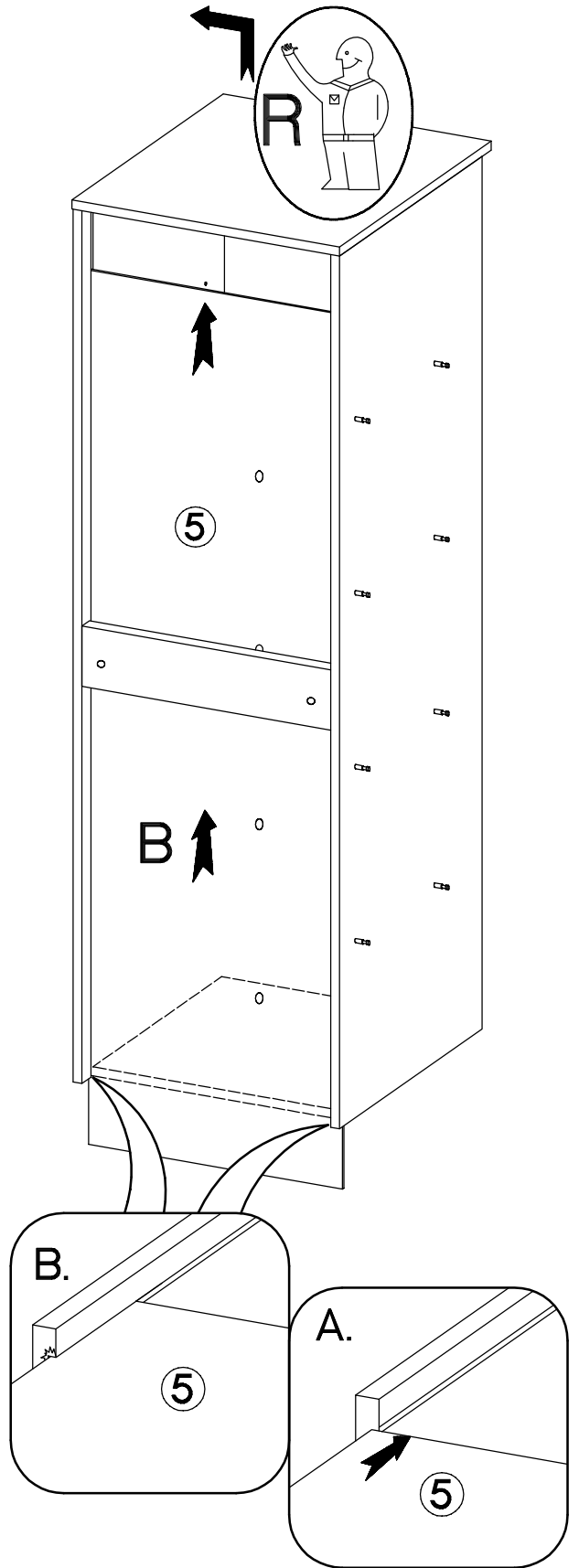

6



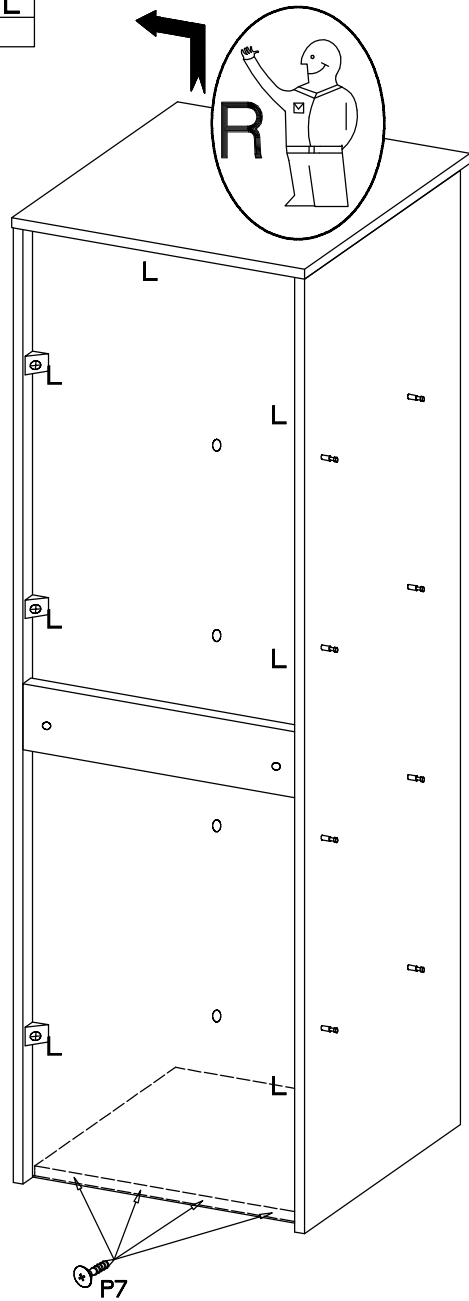
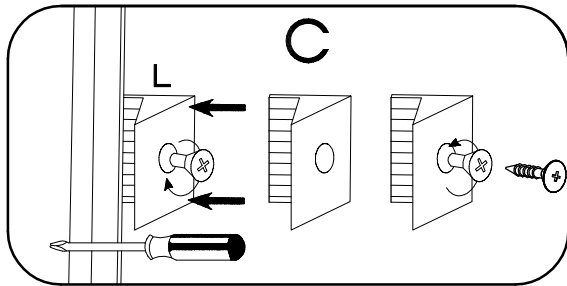
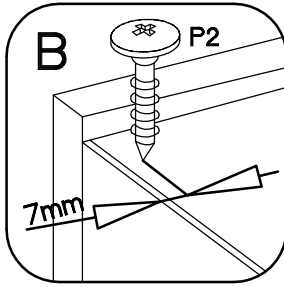
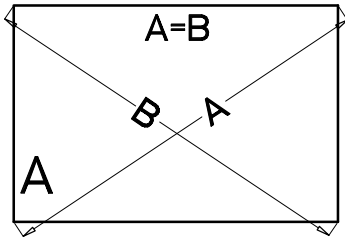

7

 P7 4	 L 14
---	---



8

 G 6	 H4 6	 P5 12
---	--	---

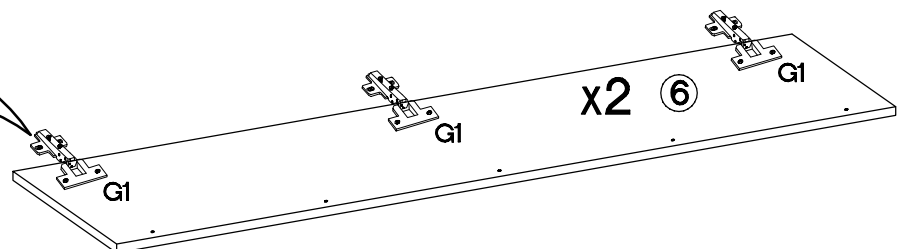
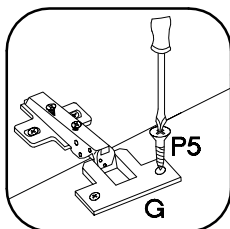
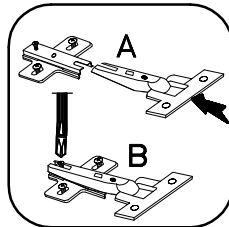

9

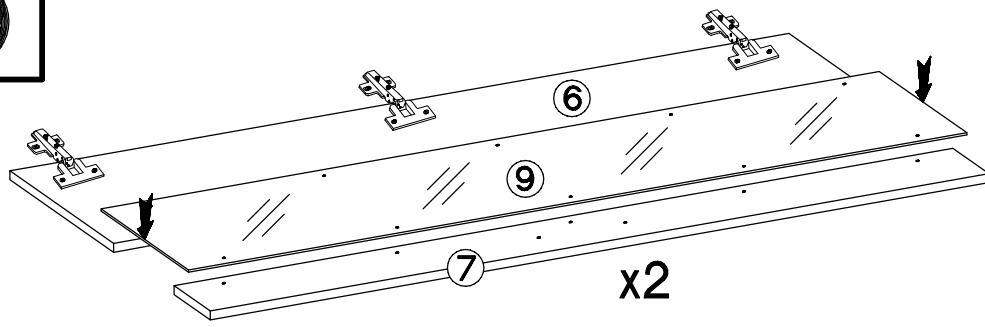

±4.0x16mm R11	±7/4mm J7
10	10

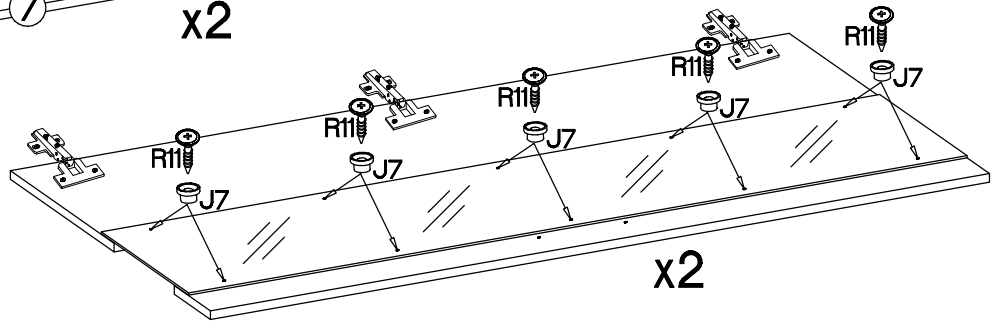
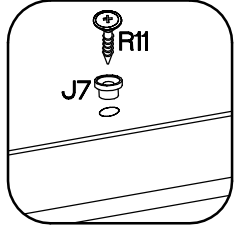

10

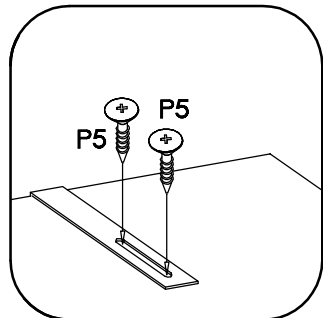
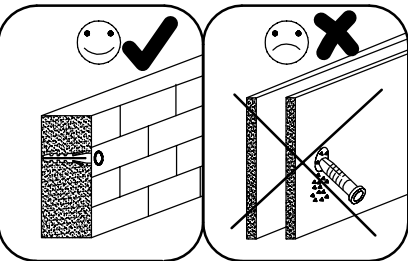
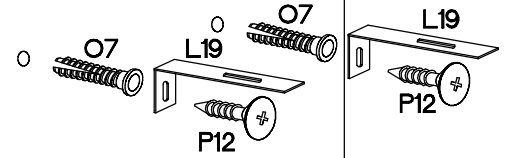
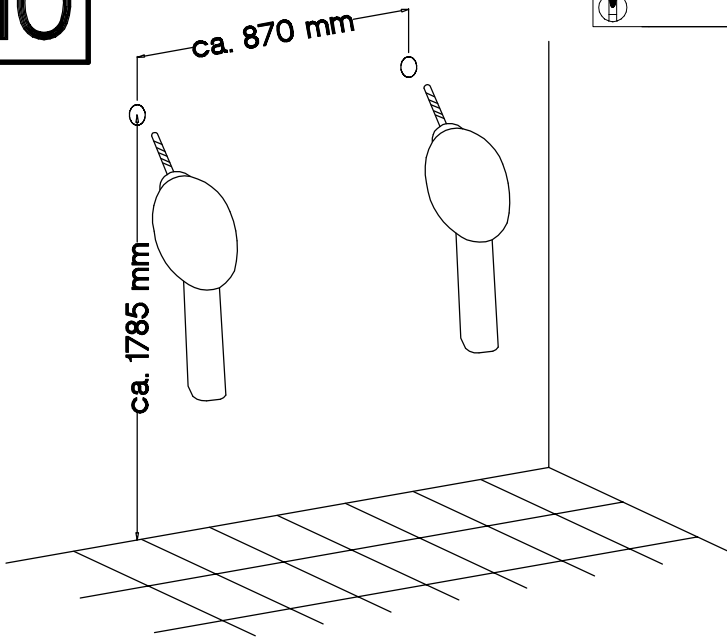

±20/25 E12	
8	
±5.0x60mm P12	±3.5x13mm P5
2	4
±10x50mm O7	L19
2	2

