

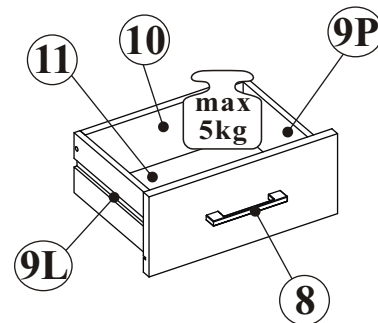

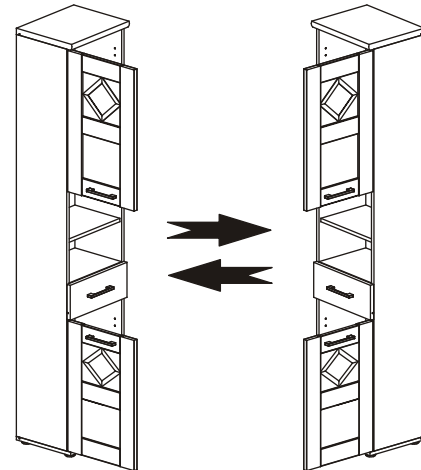

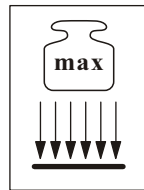

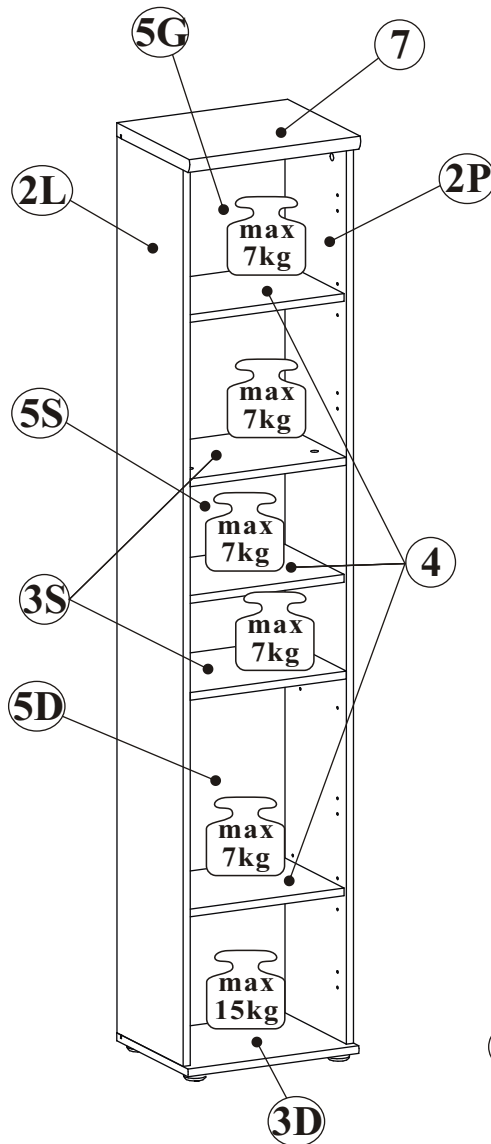

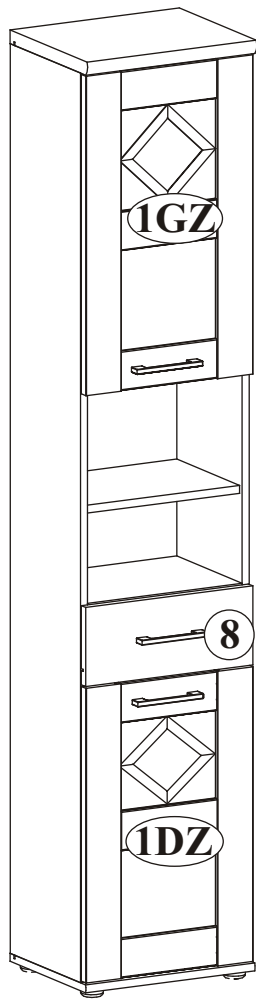
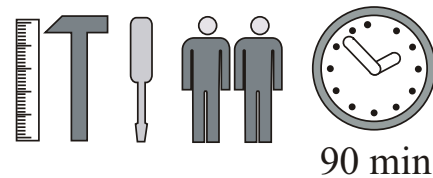

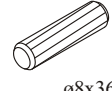
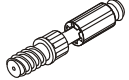



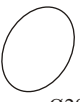
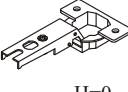
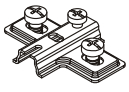

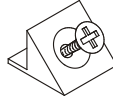
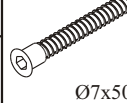





VITO COUNTRY 70-505-__-6



NO	Dim.		Col.-No	Qty
1DZ	596	376	1	1
1GZ	646	376	1	1
2L	1840	284	1	1
2P	1840	284	1	1
3D	381	307	1	1
3S	348	264	1	2
4	348	254	1	3
5D	763	360	1	1
5S	439	360	1	1
5G	650	360	1	1
7	381	314	1	1
8	376	160	1	1
9L	250	120	1	1
9P	250	120	1	1
10	315	106	1	1
11	255	326	1	1

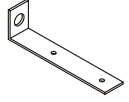

90 min

A1 x20  ø8x36	B4 x14 	B5 x12  ø15x12	G5 x12 	B7 x2  Ø15x10,3	G8 x2  Ø20
E21 x4 Ø35 H=0 	E2 x4 H=0 	D10 x10 USØ3,5x13 	S1 x15 	B11 x6 Ø7x50 	G4 x6 
H6 x1 L-250mm. 	D18 x2 M4x9 	D20 x4 ESØ6x9,5 	UP13 x10 UPØ3x16 	G16 x6 	Z2 x8 Ø5 
W128 x3 	UP16 x6 UPØ4x35 	I11 x4 Ø45, h=15 	UP11 x4 UPØ4x20 	G7 x12 	G2 x1 
KR1 x1 	L1 x1 	GU x4 Ø35 			

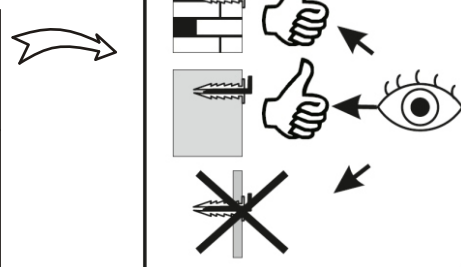
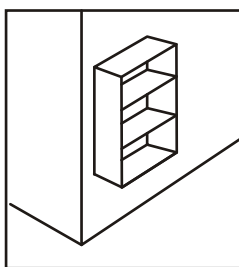
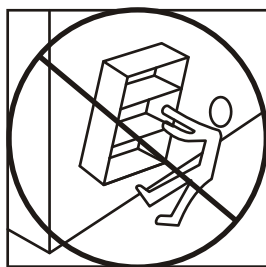
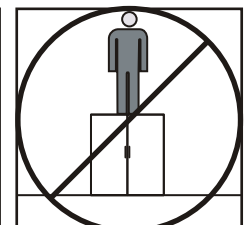
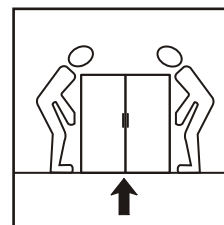
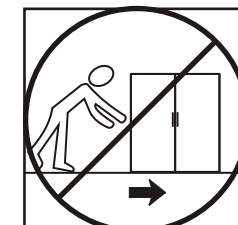
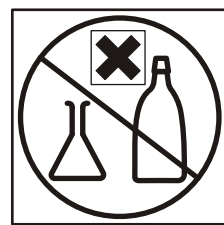
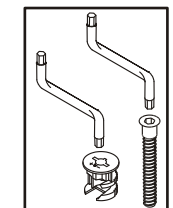
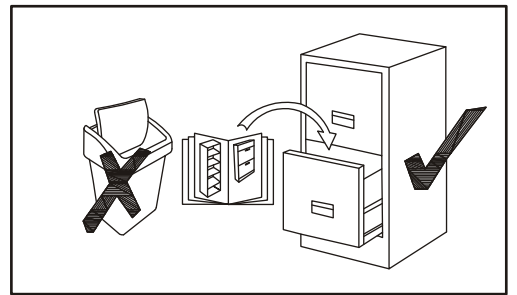
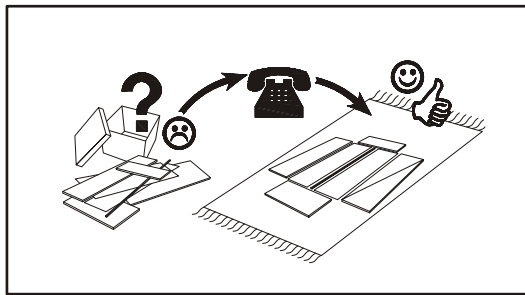
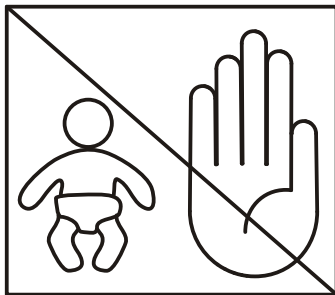
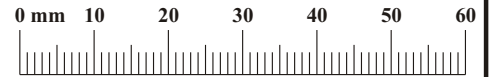

1

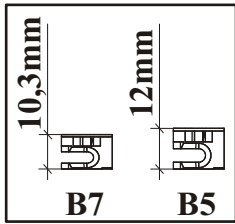

A1 x8	ø8x36	B5 x4	ø15x12	B4 x8	
H6 x1	L-250mm.	D20 x4	ES06x9,5	G7 x12	

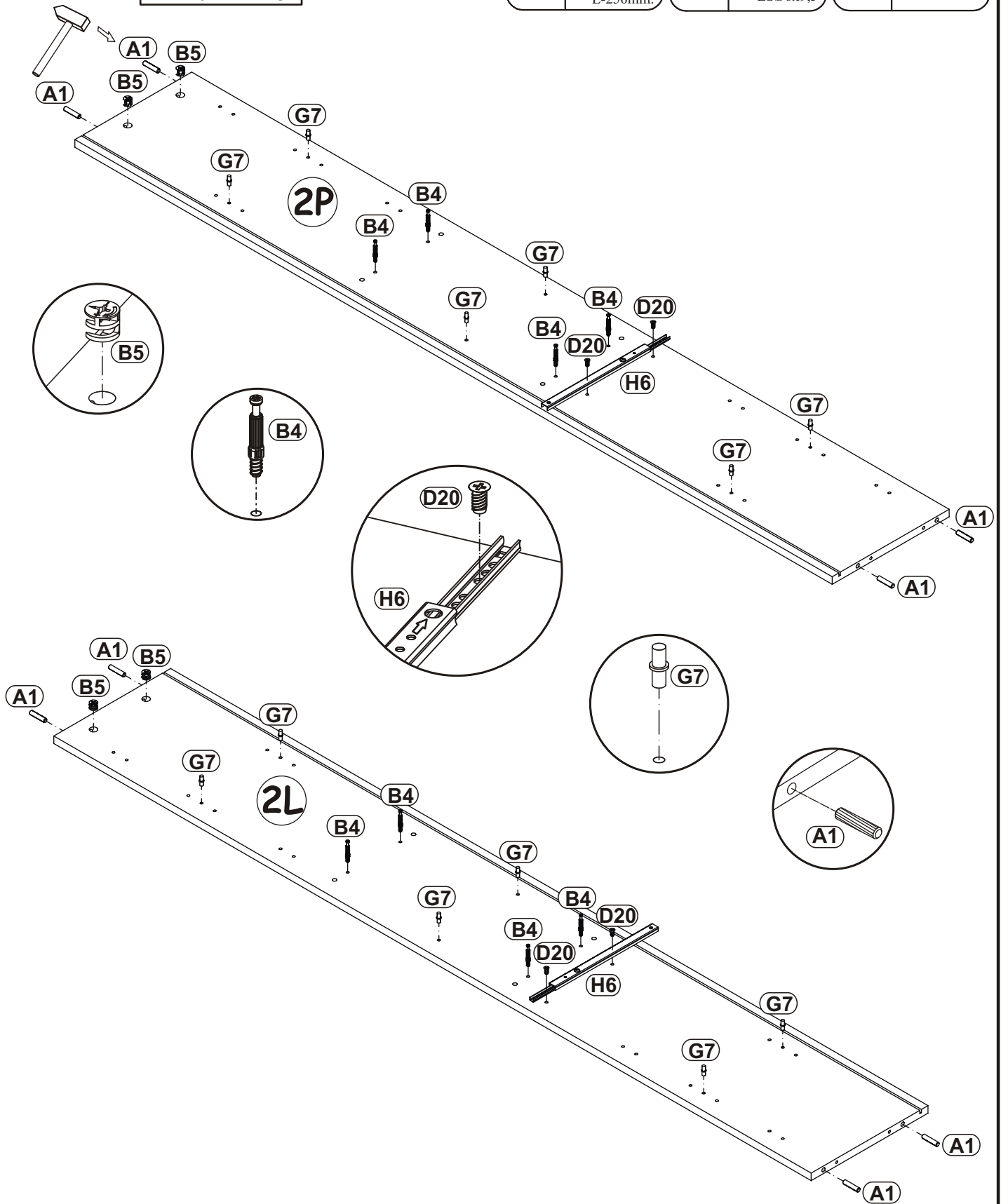

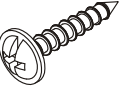
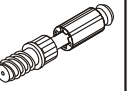

I11		UP11		B4	
x4	Ø45, h=15	x4	UPØ4x20	x4	

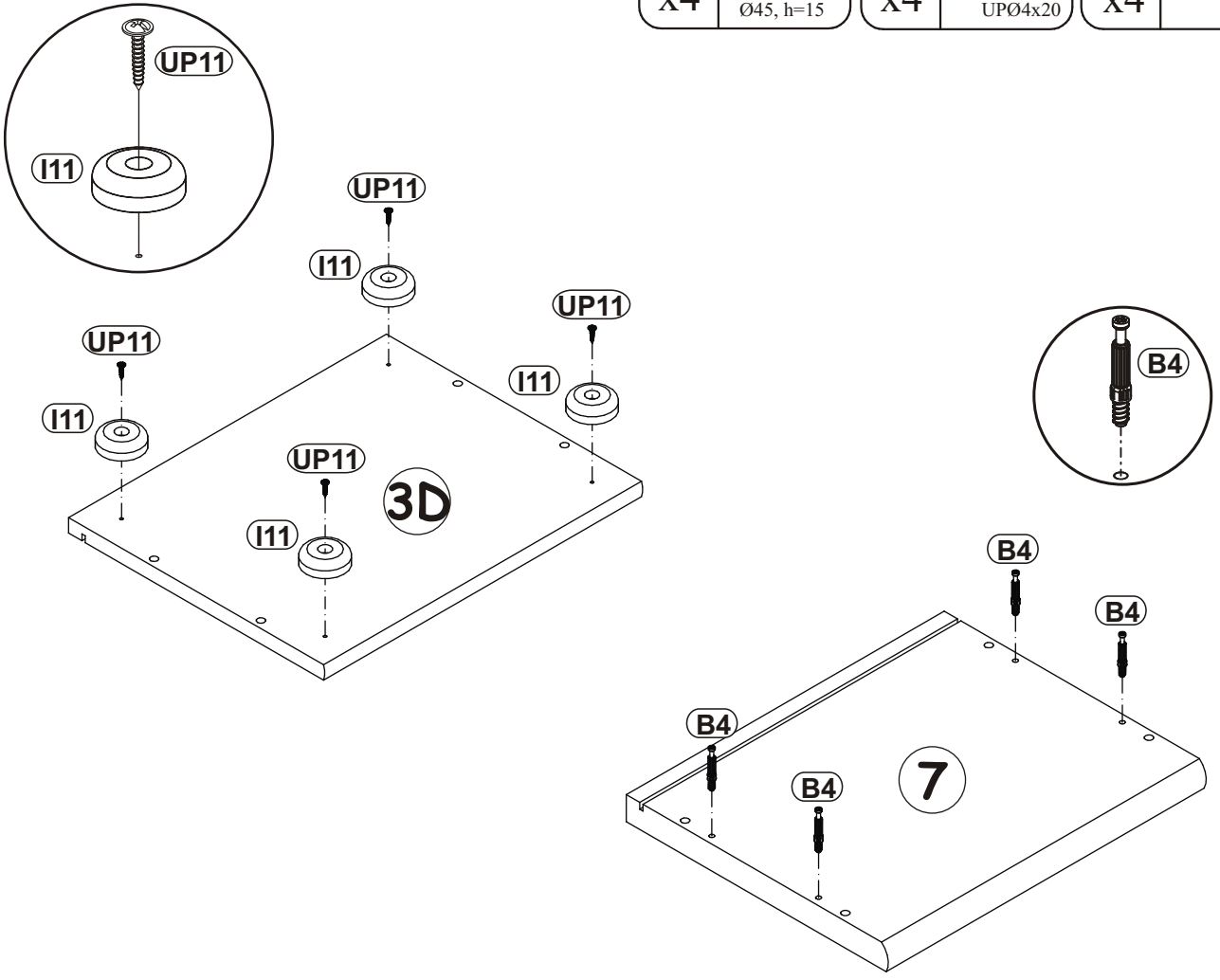
2

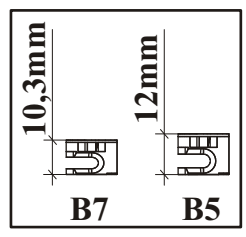

3

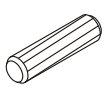

A1		B5	
x8	ø8x36	x8	ø15x12

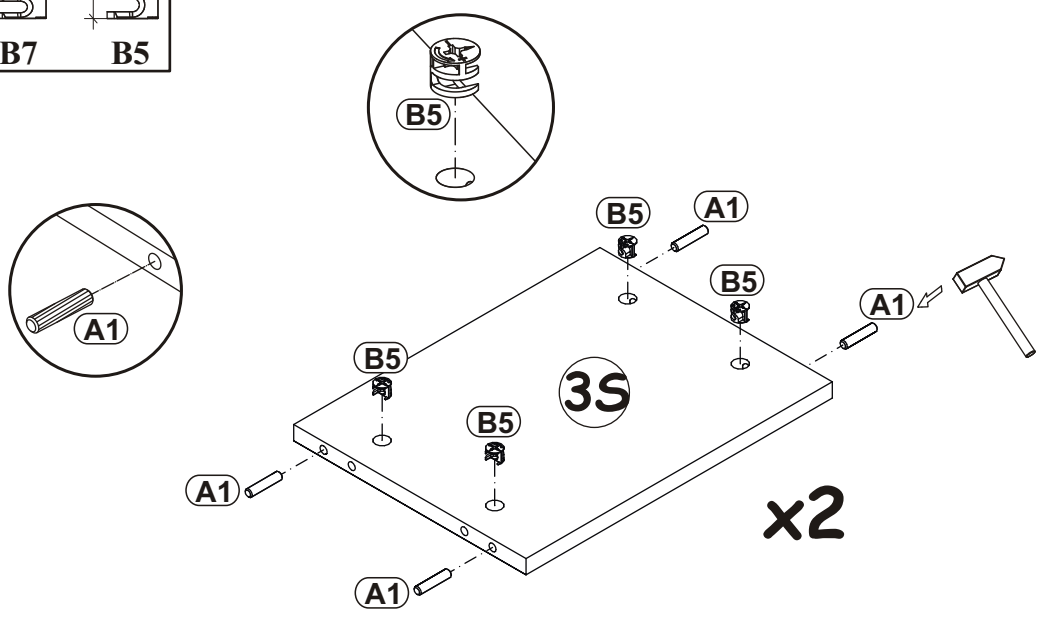

4

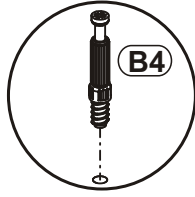
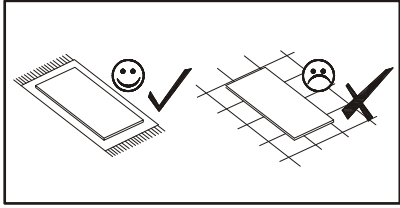

B4	
x2	

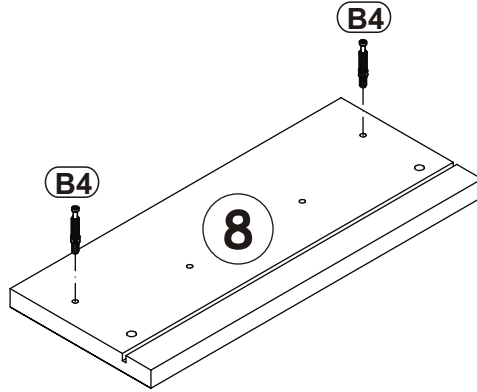

5

A1	
x4	ø8x36

B7	
x2	Ø15x10,3

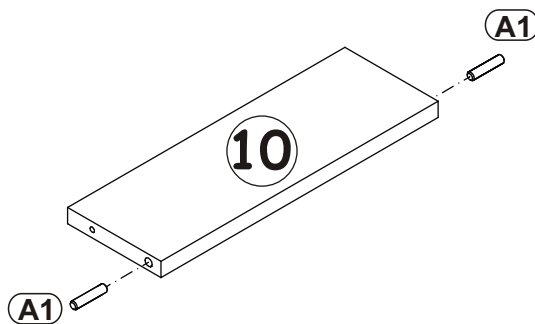
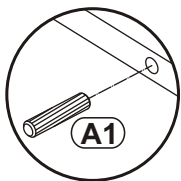
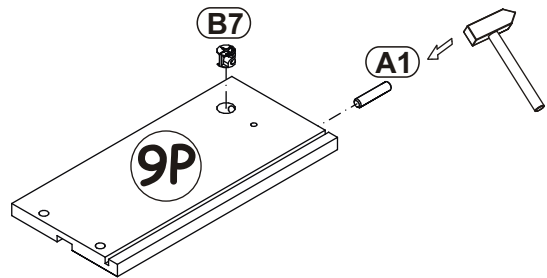
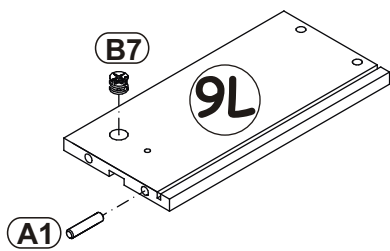
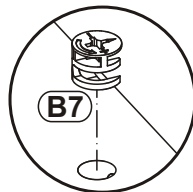
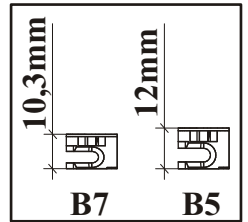

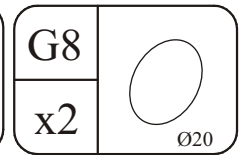
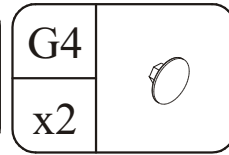
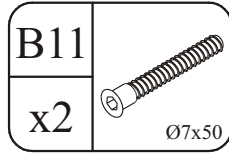

6

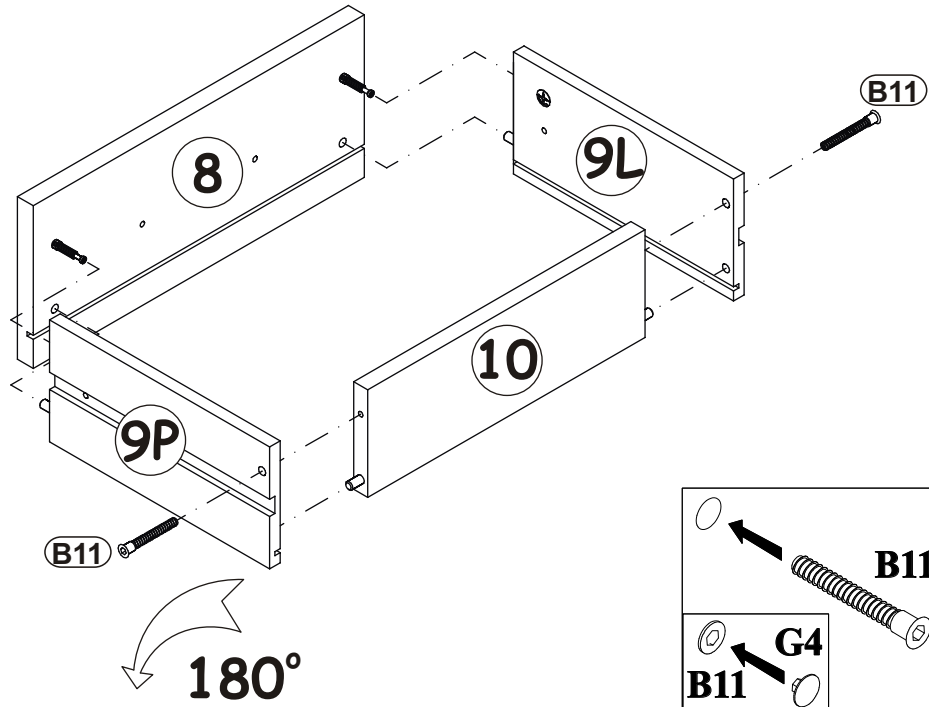
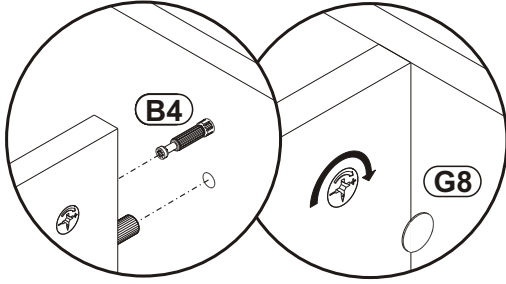

7

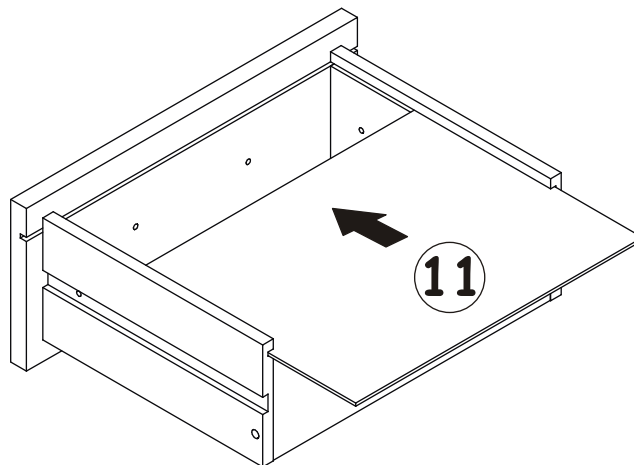

8

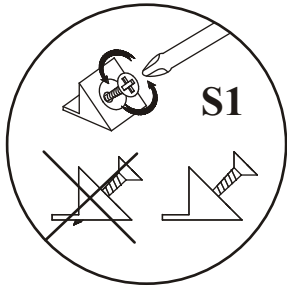

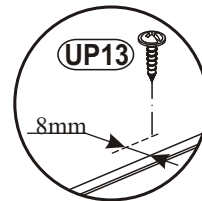
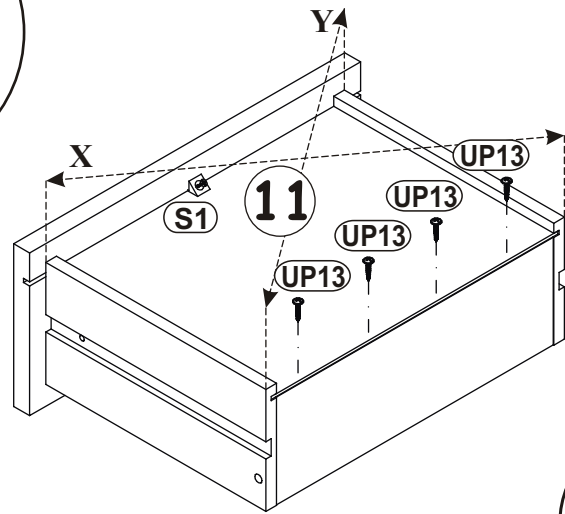

S1		UP13	
x1		x4	UPØ3x16

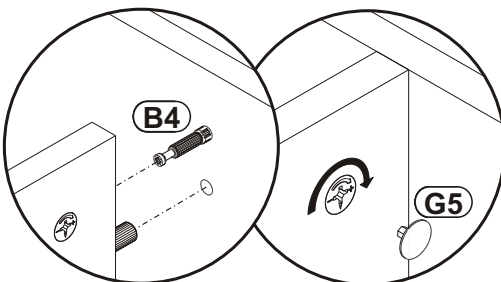
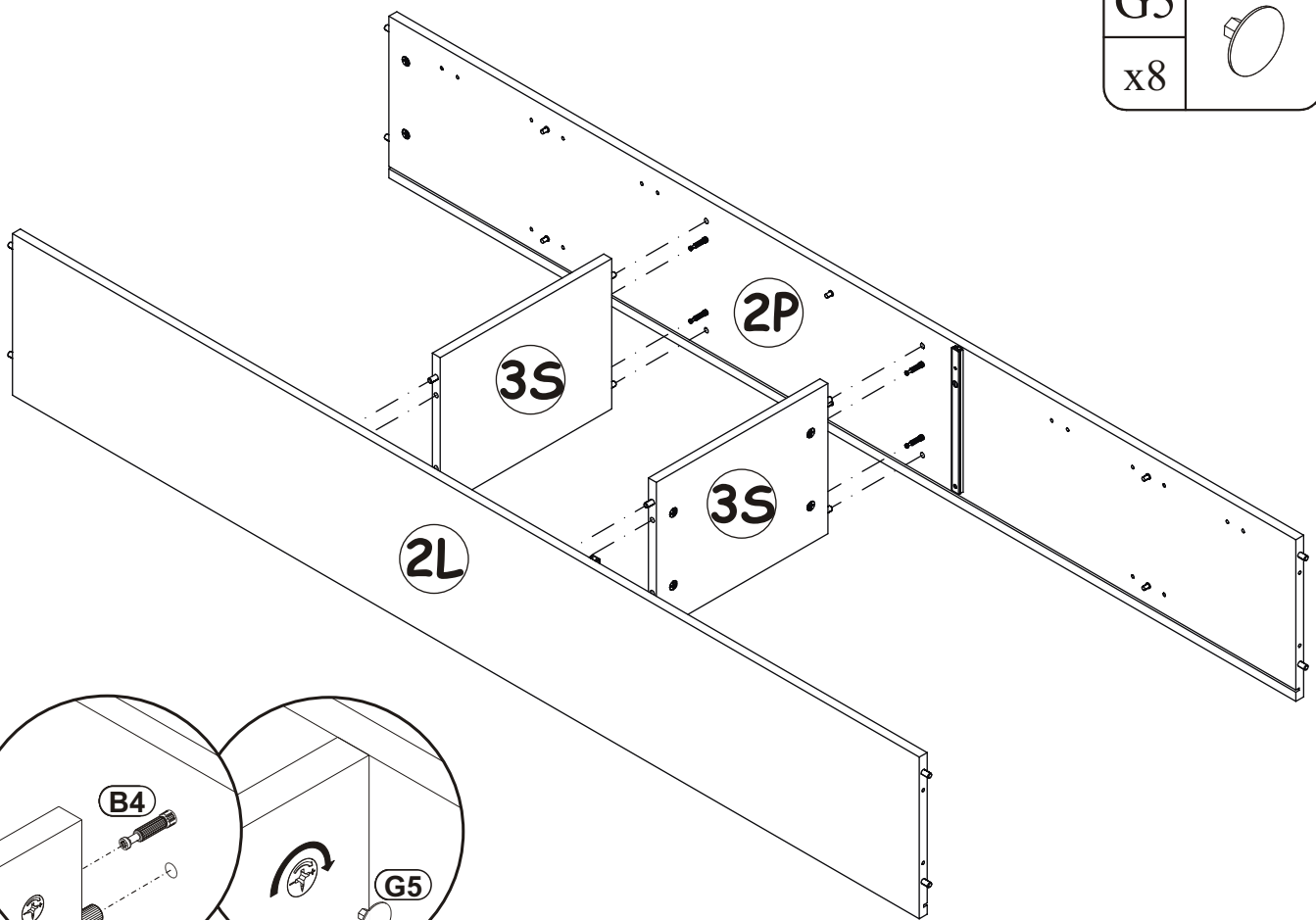

9

G5	
x8	



B11		G4	
x4	Ø7x50	x4	

10

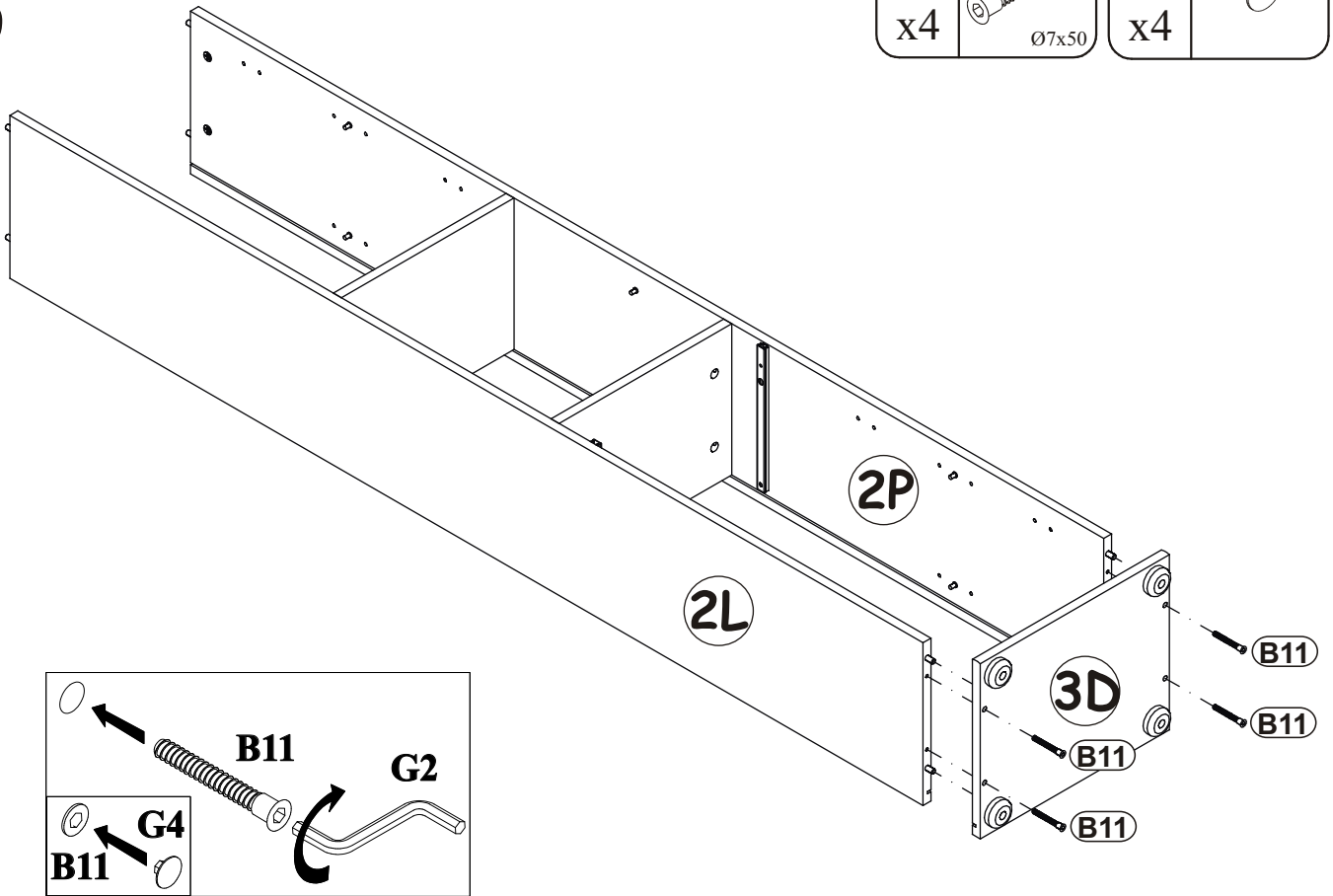

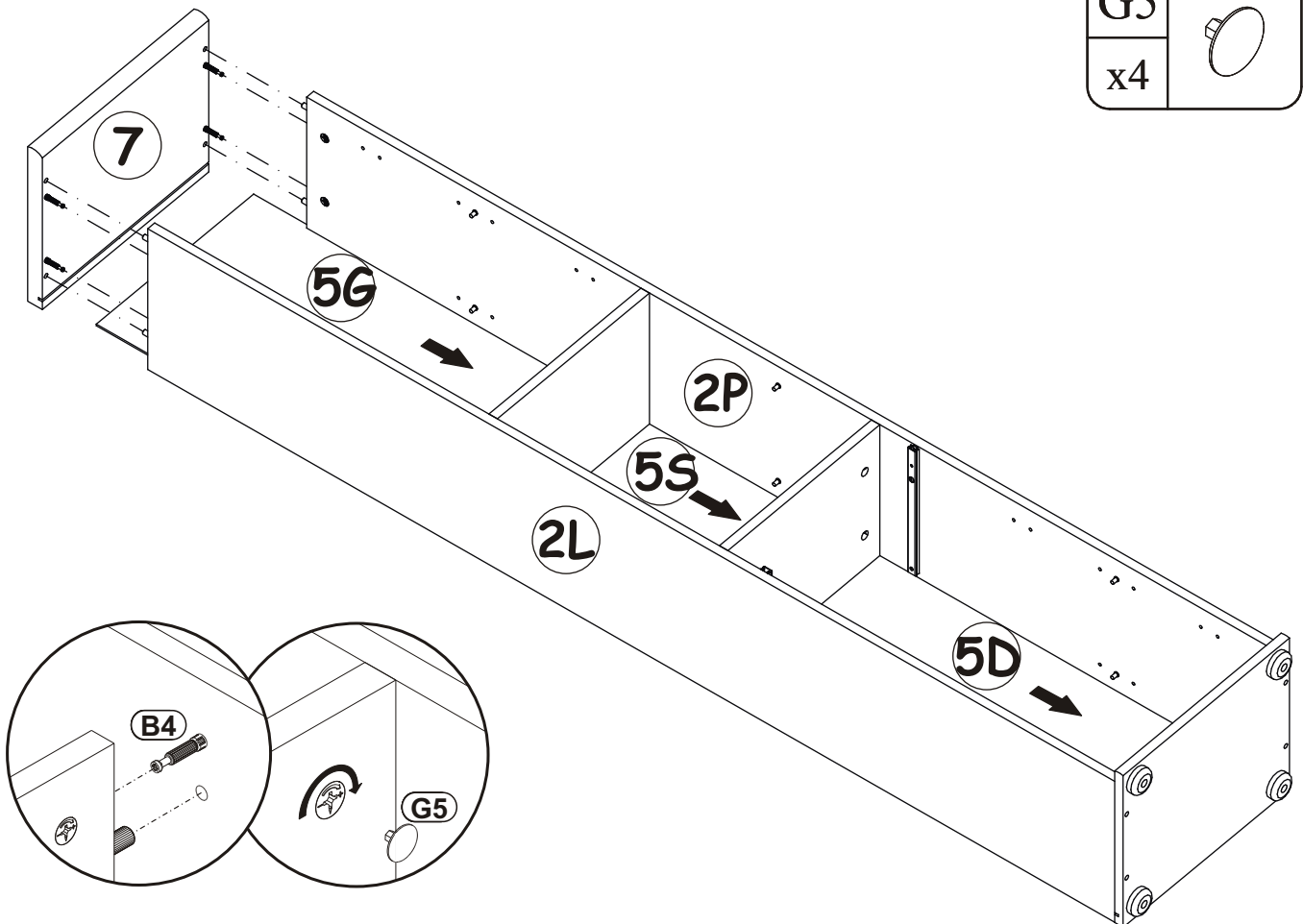

11

G5	
x4	

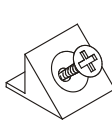

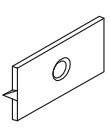
S1	
x14	

G16	
x6	

UP13	
x6	

12

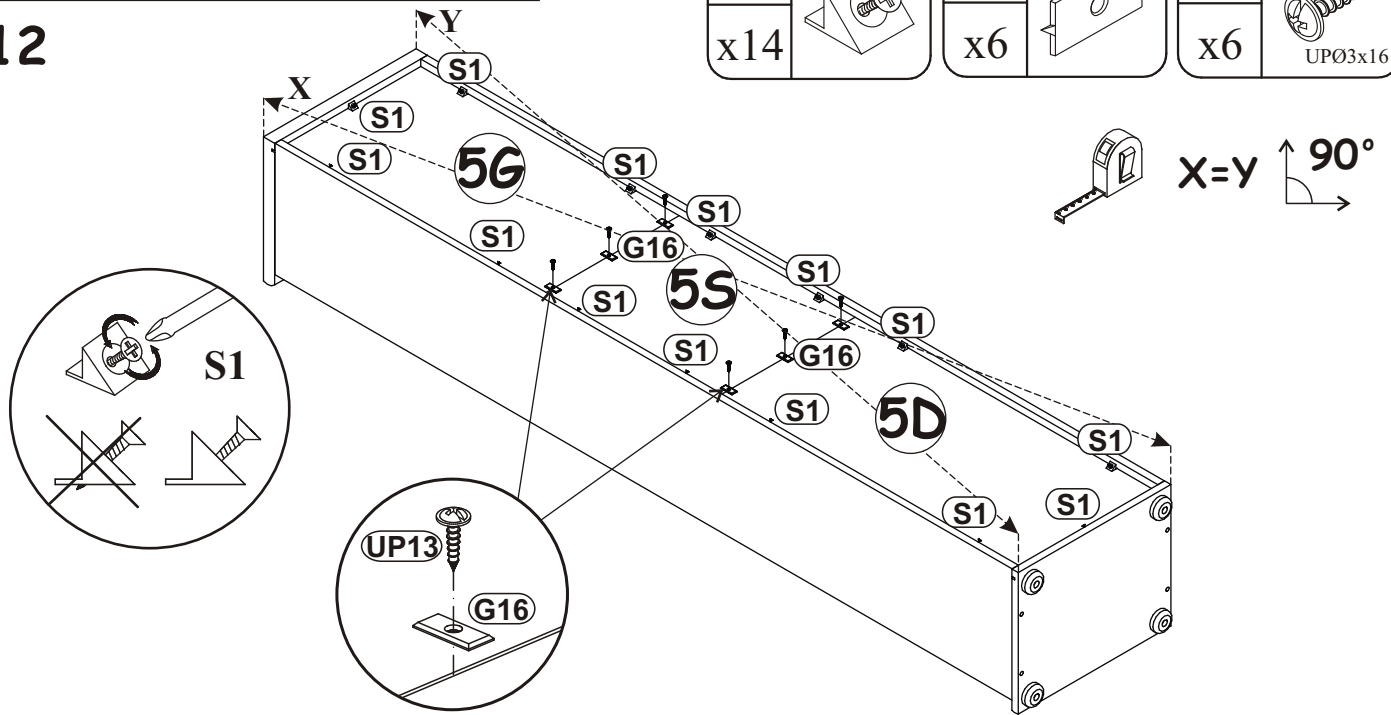

13

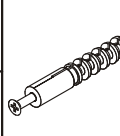
KR1	
x1	

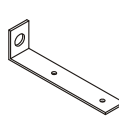
L1	
x1	

D10	
x2	

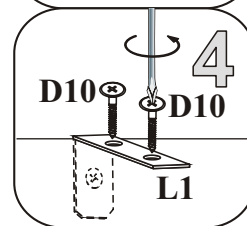
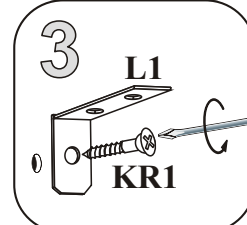
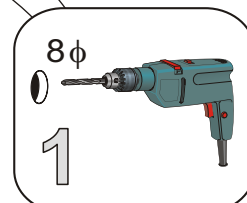
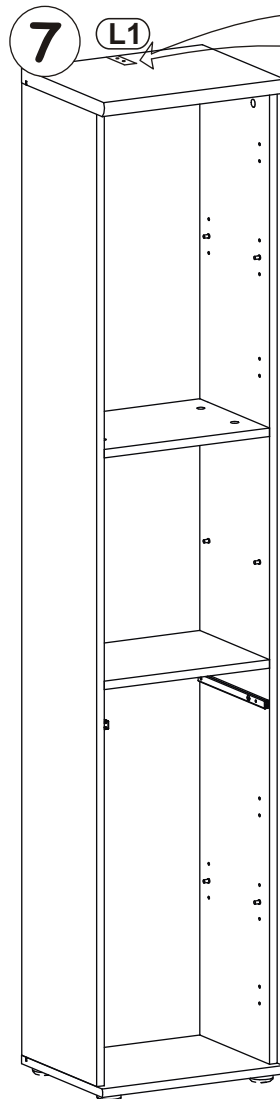
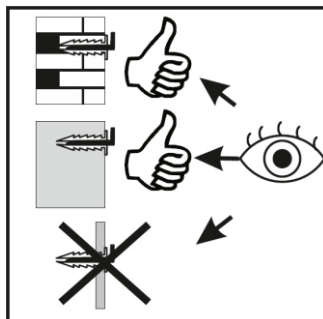

14-17

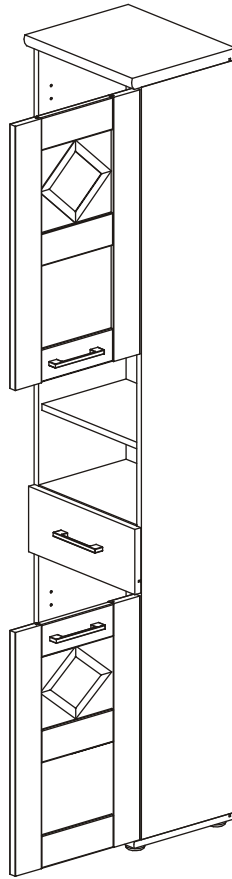

18-21

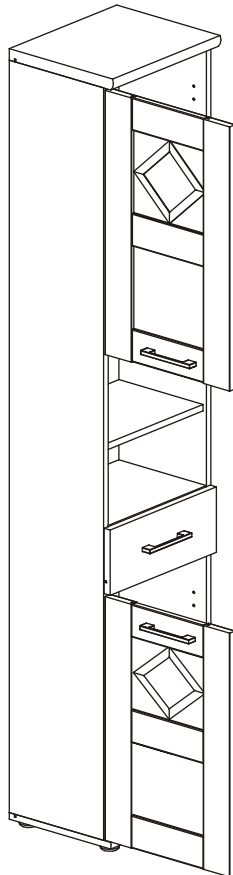

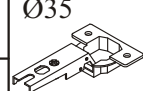
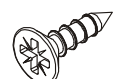
GU		E21		D10	
x4	Ø35	x4	H=0	x8	USØ3,5x13

14

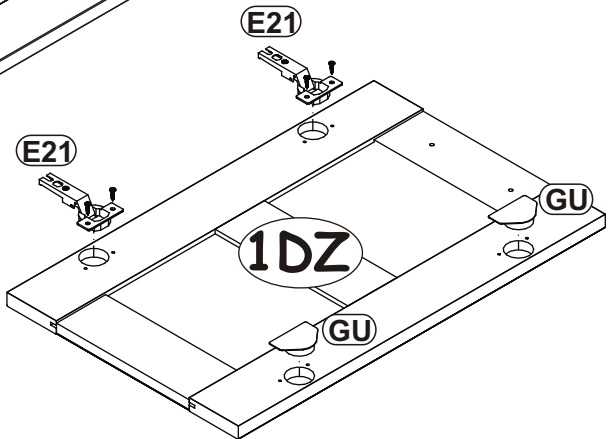
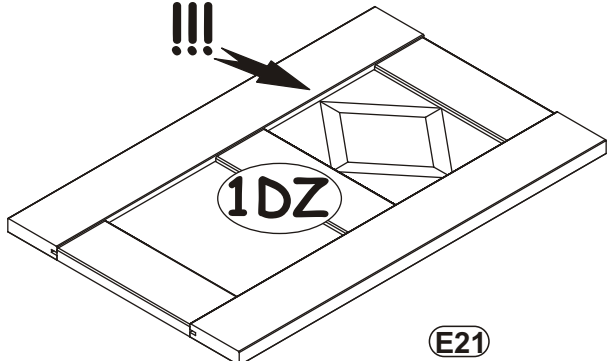
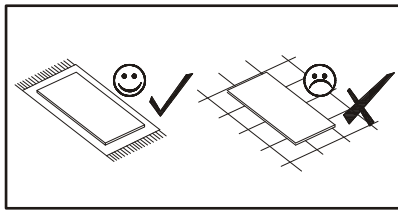
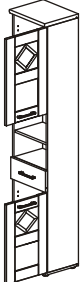

180°

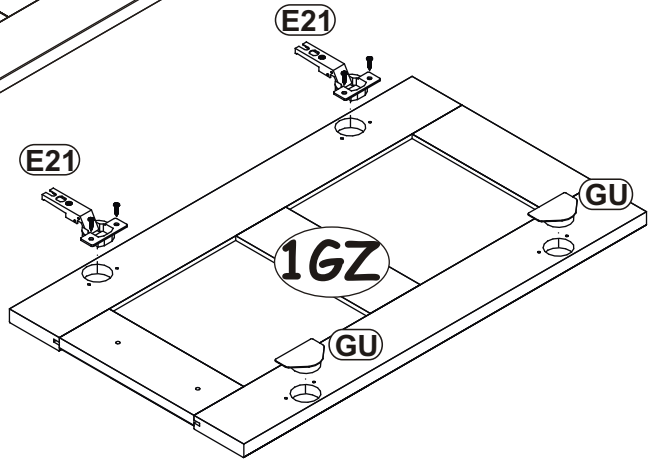
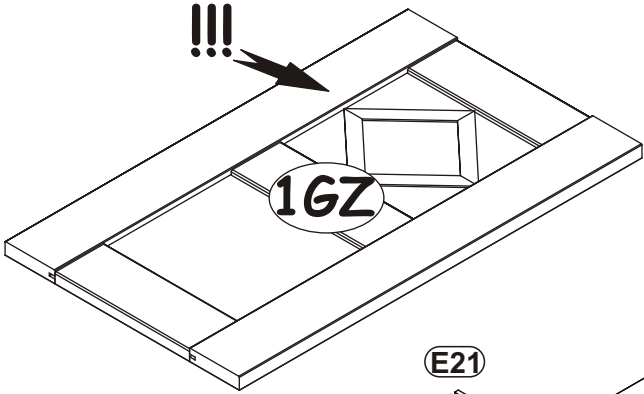
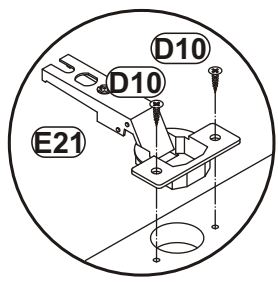

180°

15

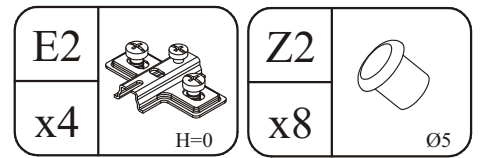
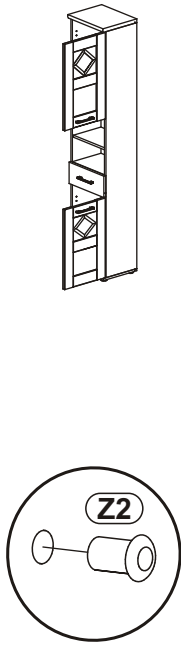



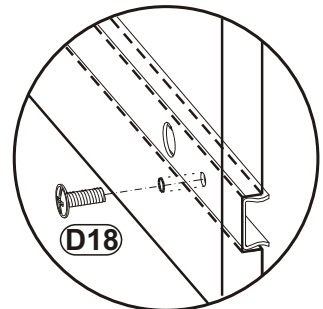
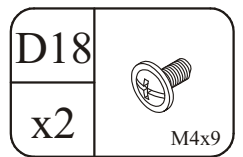
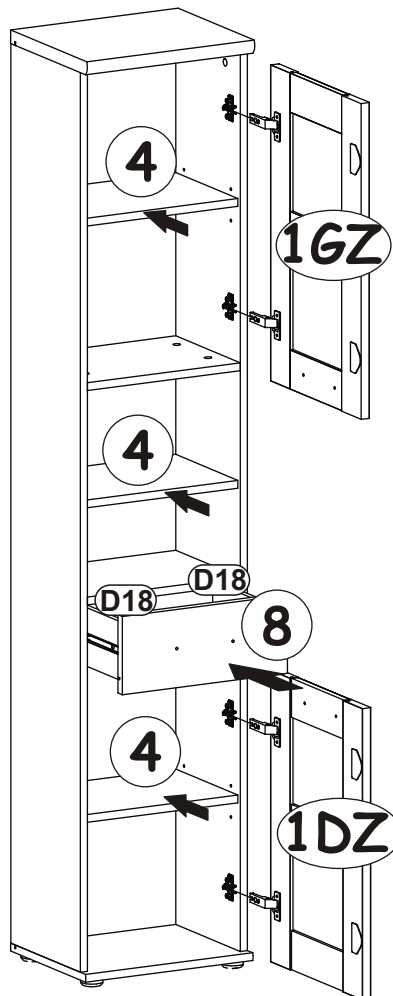
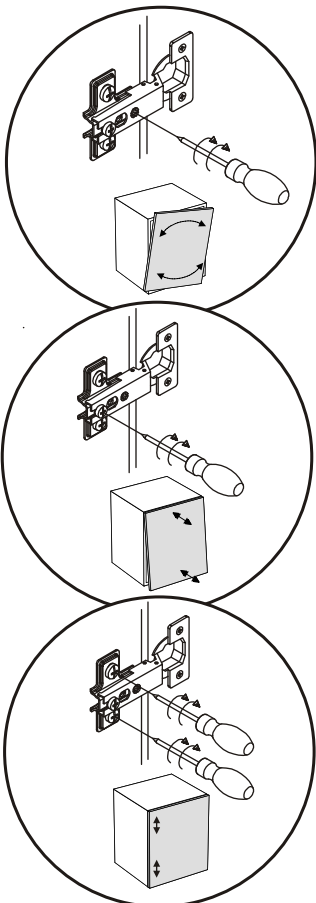

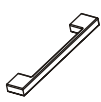
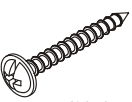
16

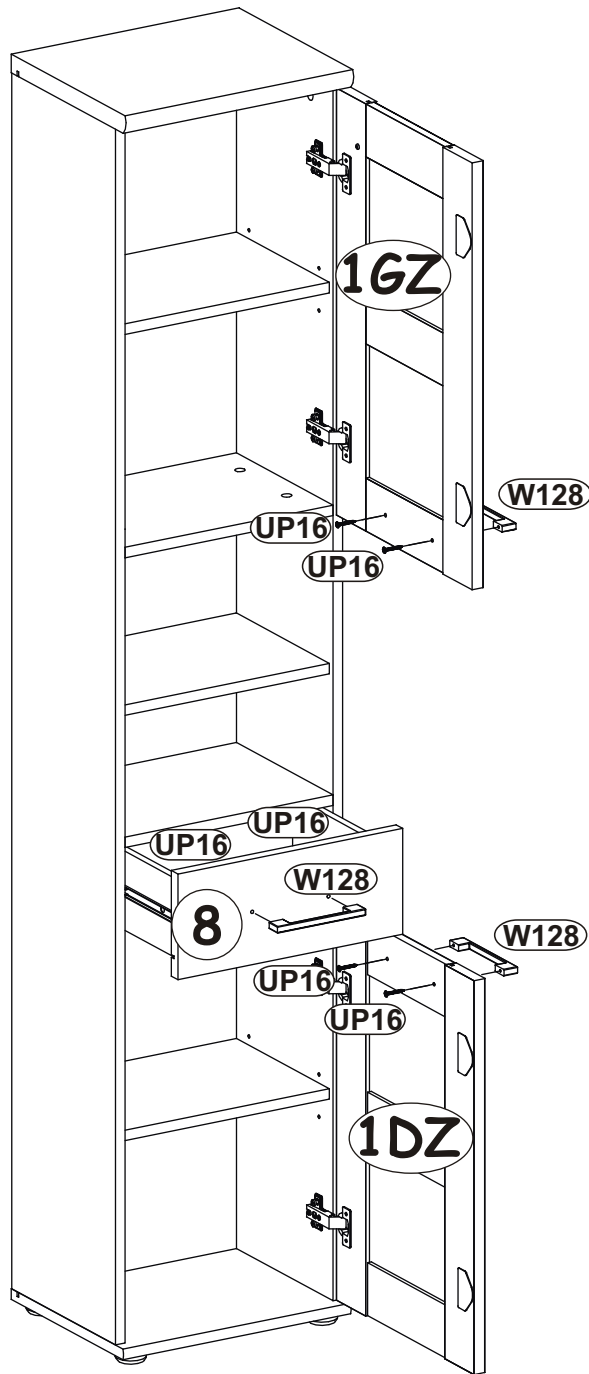
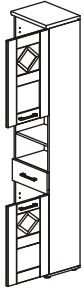

W128		UP16	
x3		x6	UPØ4x35

17

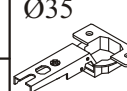

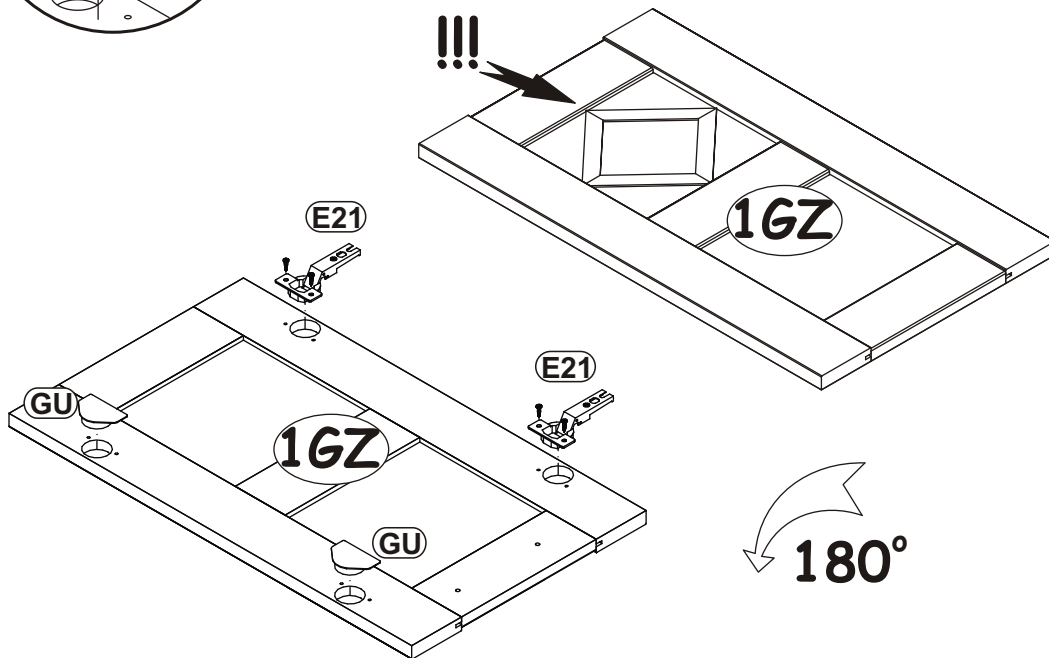
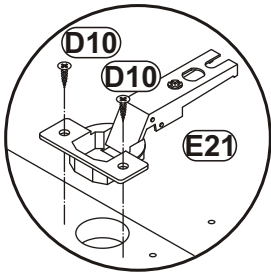
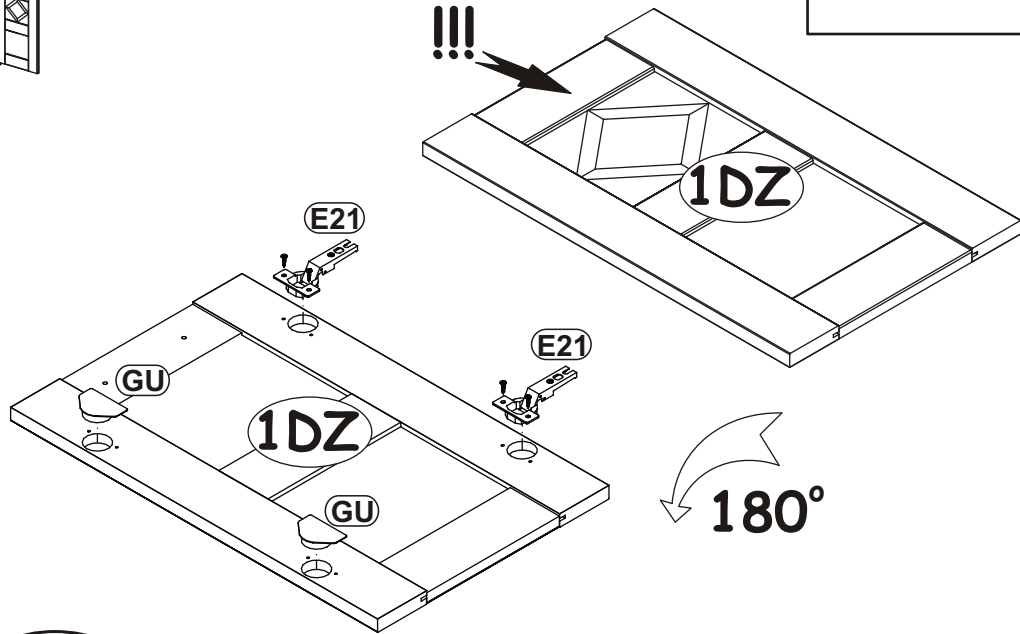
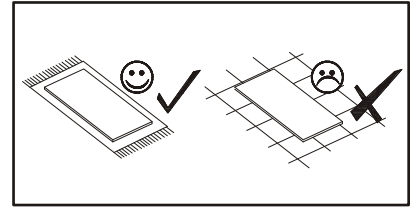
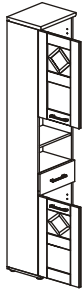

GU		E21		D10	
x4	Ø35	x4	H=0	x8	USØ3,5x13

18

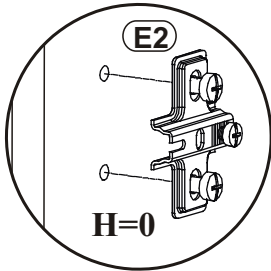
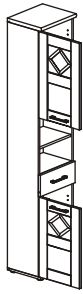

19

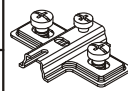

E2		Z2	
x4	H=0	x8	Ø5

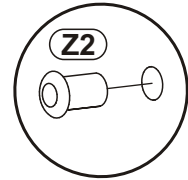

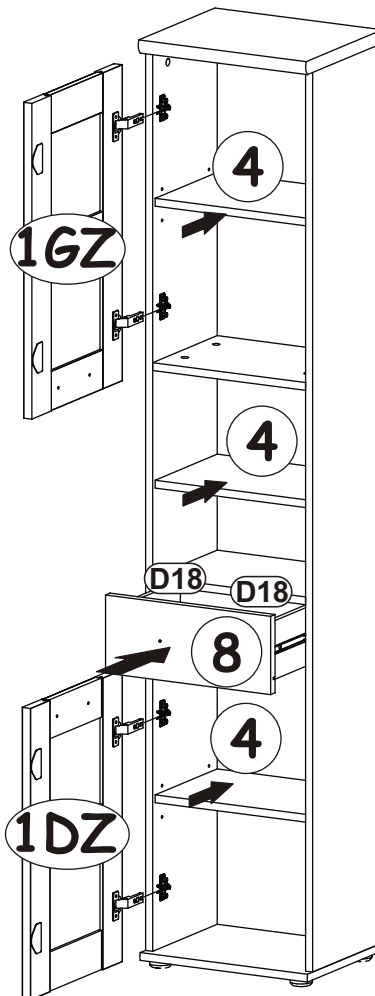
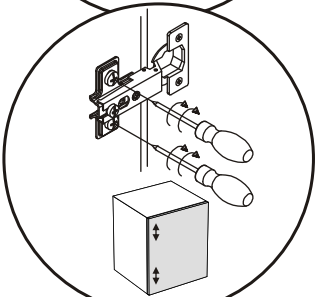
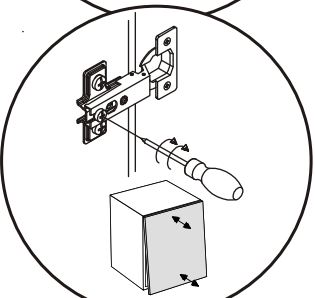
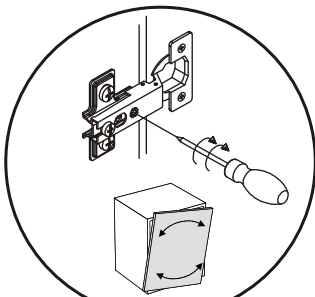

20

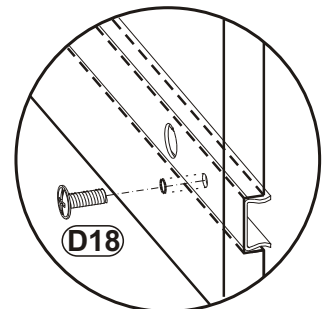
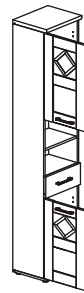

D18	
x2	M4x9

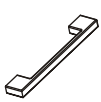

21

W128		UP16	
x3		x6	UPØ4x35

