

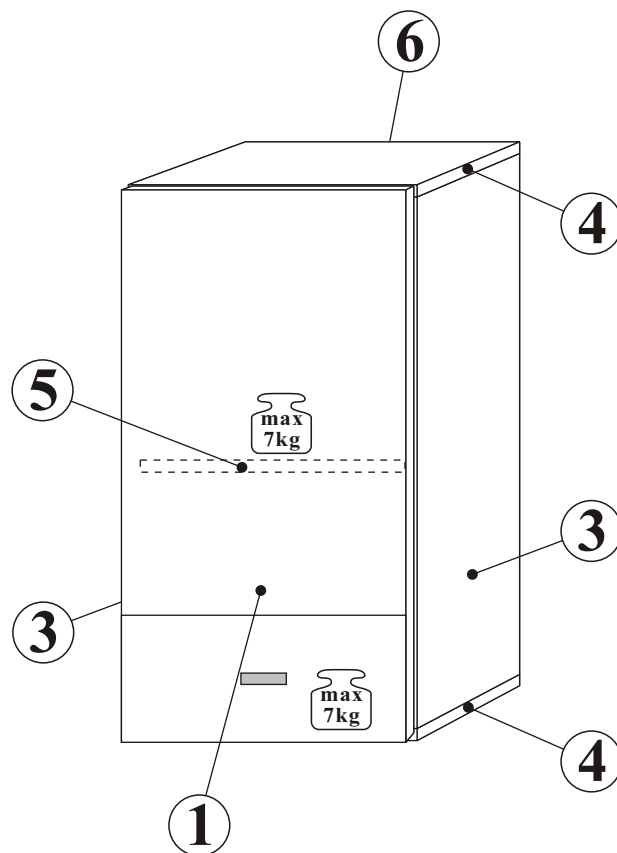

60 min

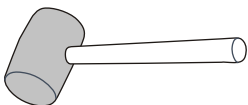

NO	Dim.		Col.-No	Qty
1	731	376	1	1
3	703	235	1	2
4	382	235	1	2
5	348	205	1	1
6	714	359	1	1

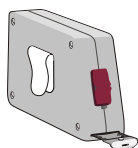
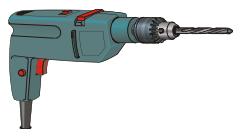
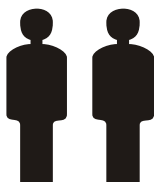
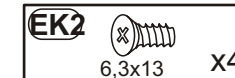
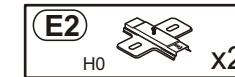
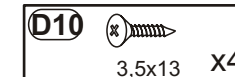
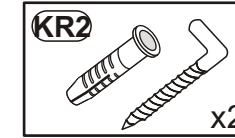
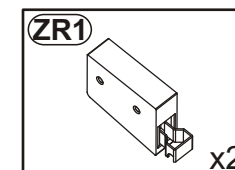
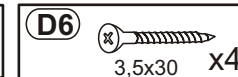
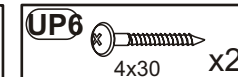
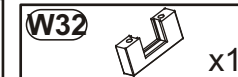
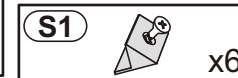
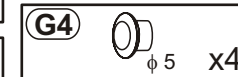
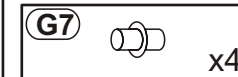
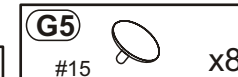
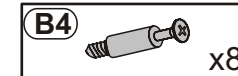
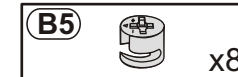
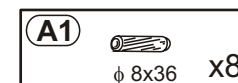
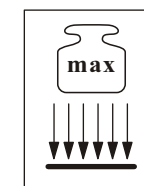

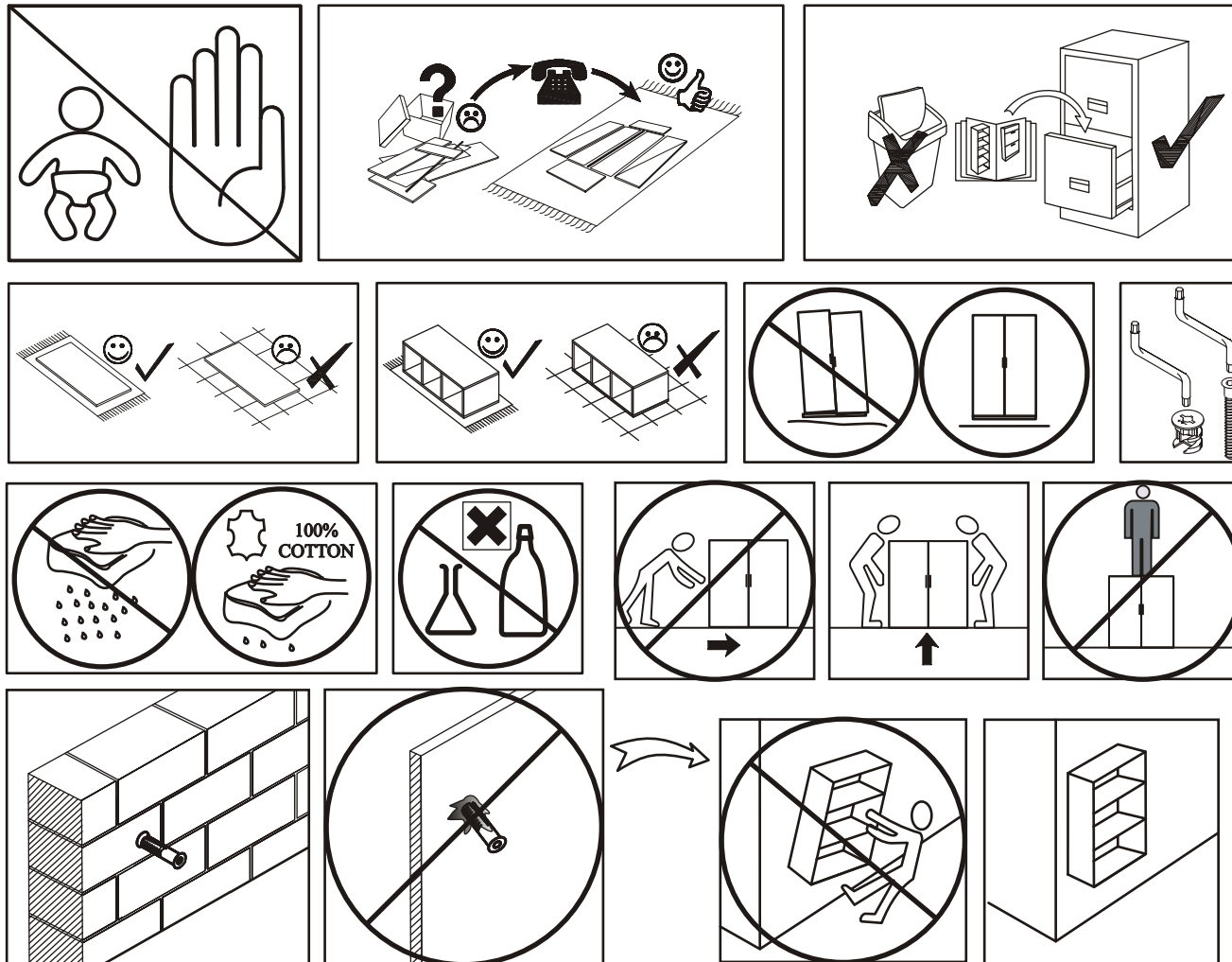

1

- E2** H0 x2
- A1** ϕ 8x36 x8
- EK2** 6,3x13 x4
- B5** x8
- B4** x8

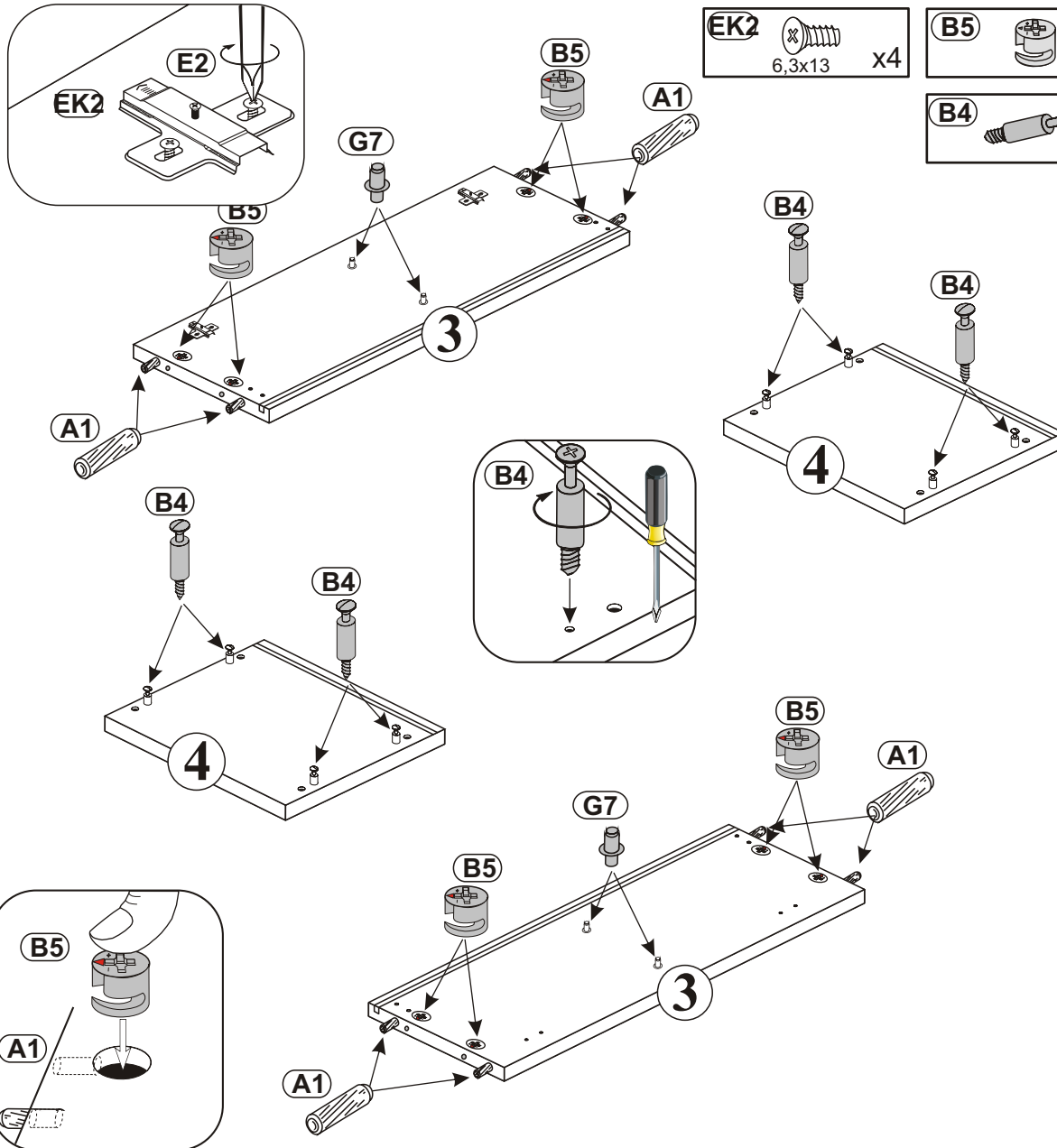

2

- E1** Kr0 x2
- D10** 3,5x13 x4
- W32** x1
- UP6** 4x30 x2

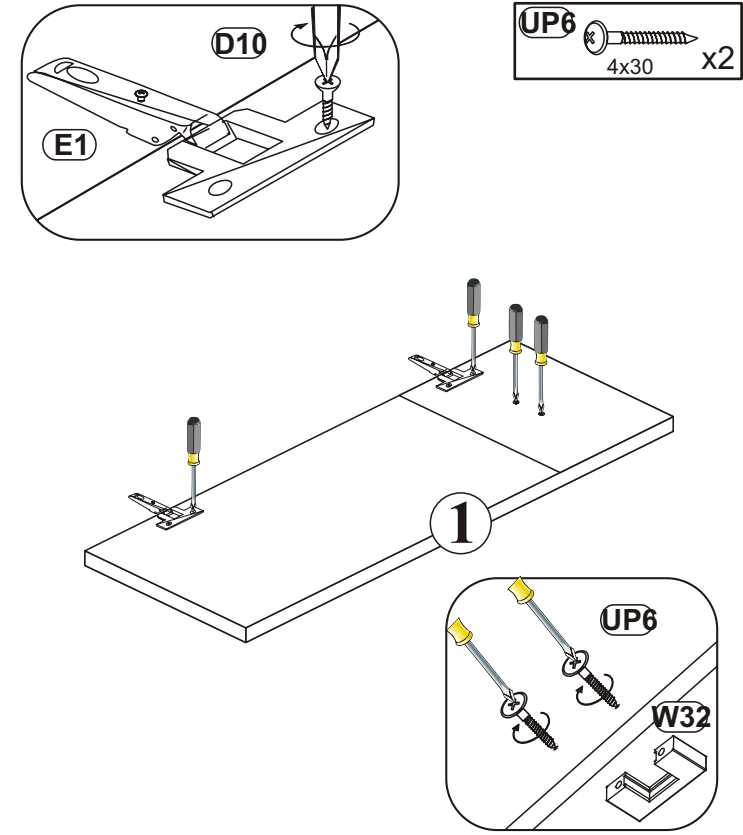

3

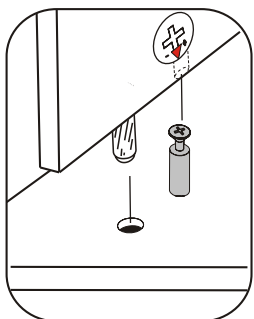
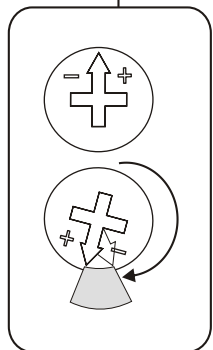
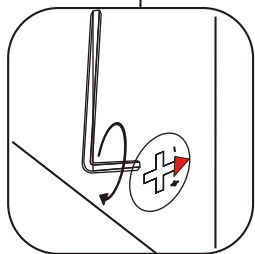
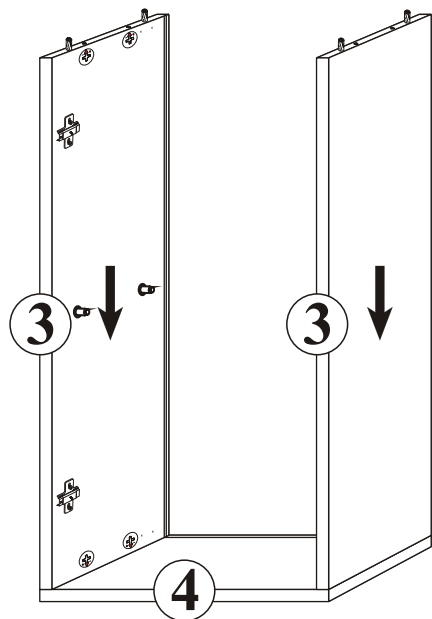

4

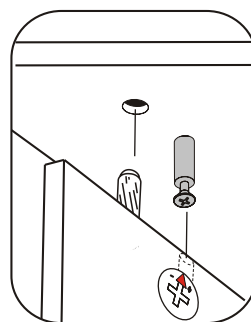
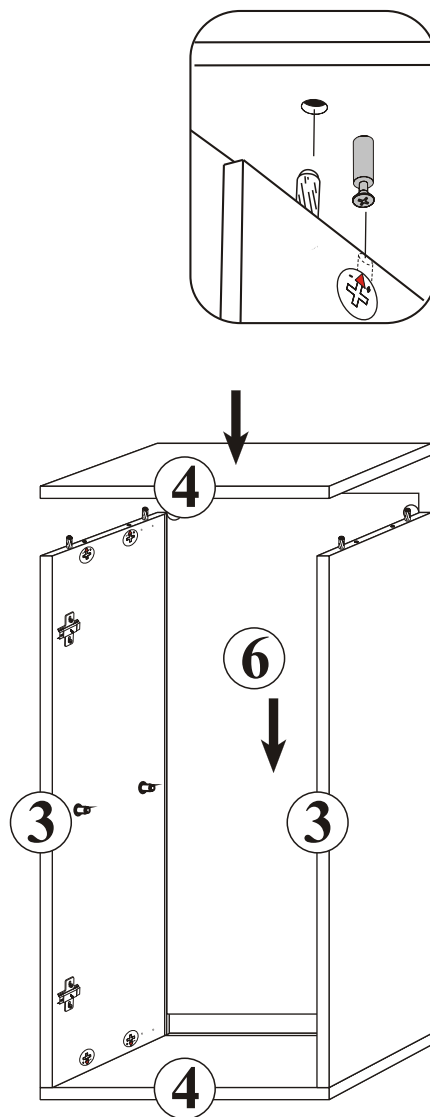

5

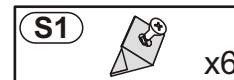

a=b

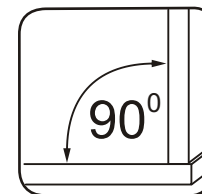
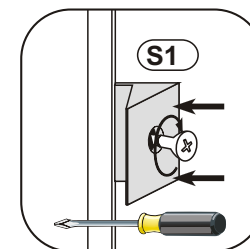
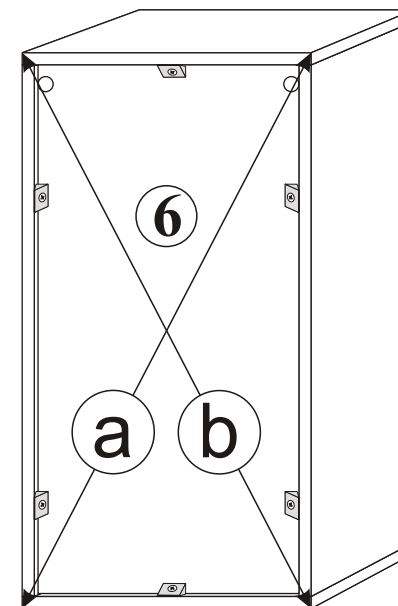

6

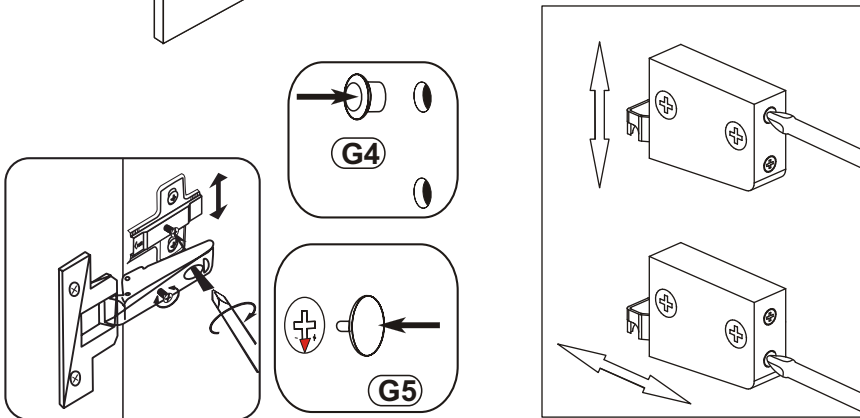
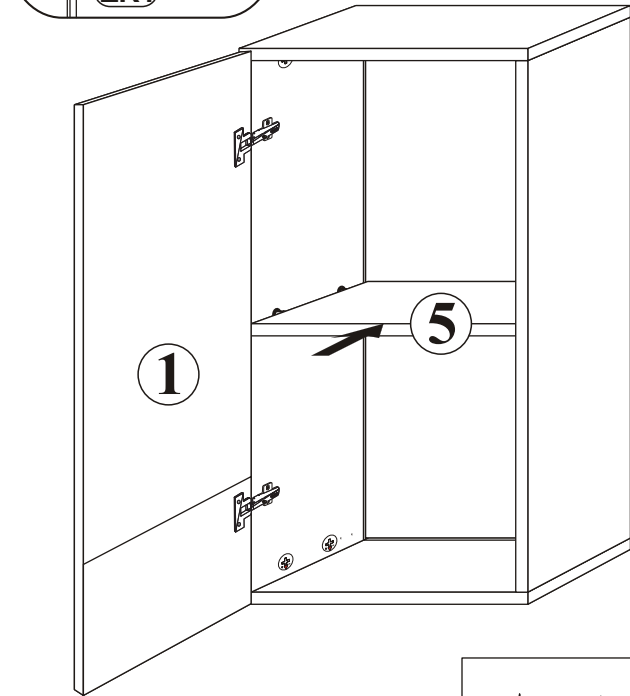
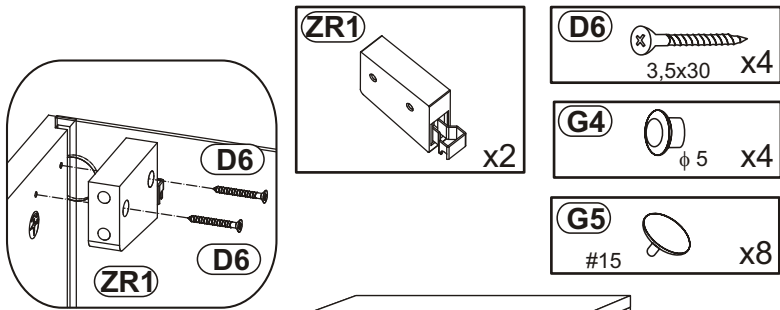

7

