

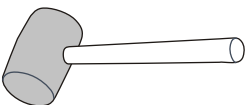

60 min

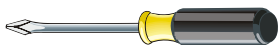

NO	Dim.	Col.-No	Qty
1L	1974 296	1	1
1P	1974 296	1	1
2L	1948 330	1	1
2P	1948 330	1	1
3	601 330	1	1
3G	567 310	1	1
4	567 300	1	1
5	1959 288	1	2
7	601 330	1	1

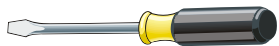
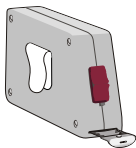
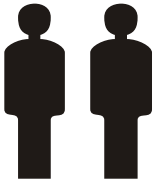
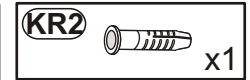
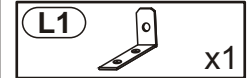
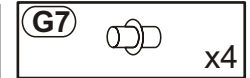
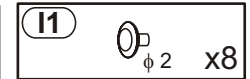
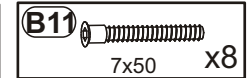
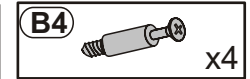
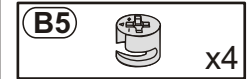
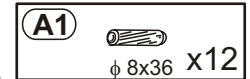
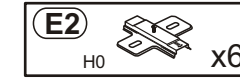
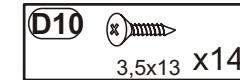
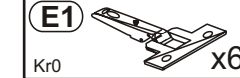
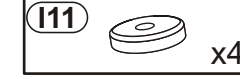
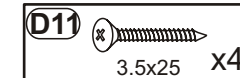
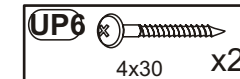
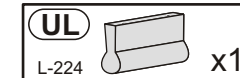
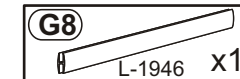
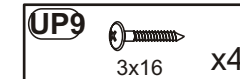
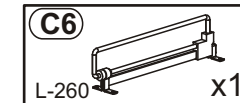
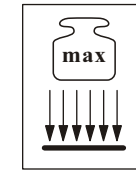
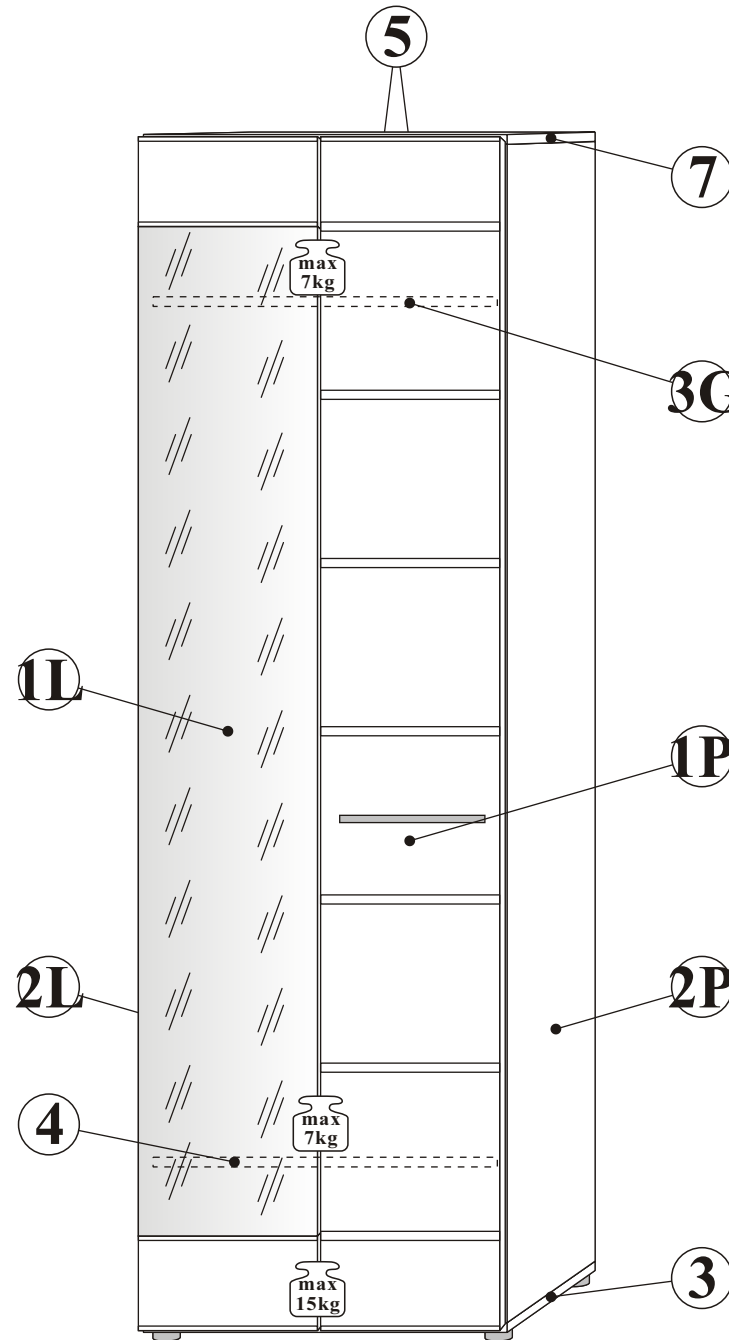

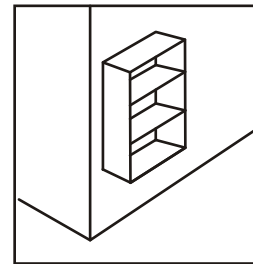
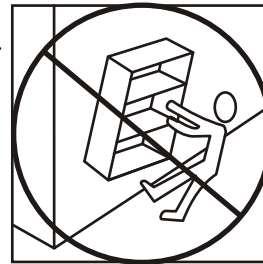
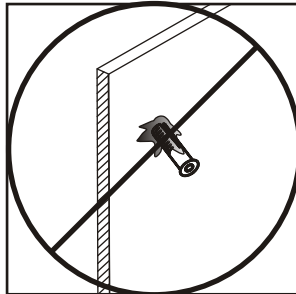
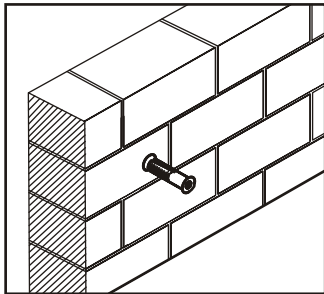
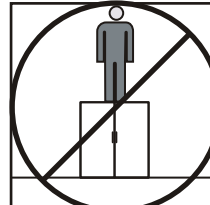
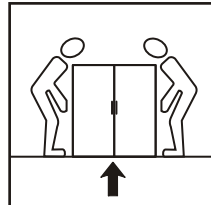
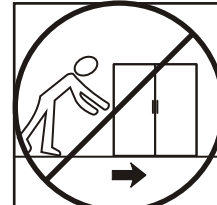
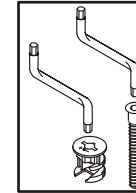
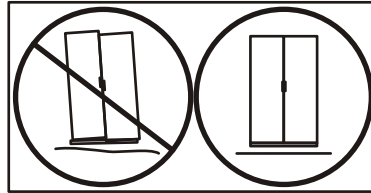
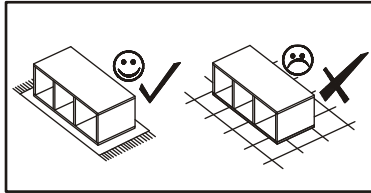
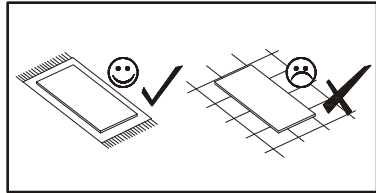
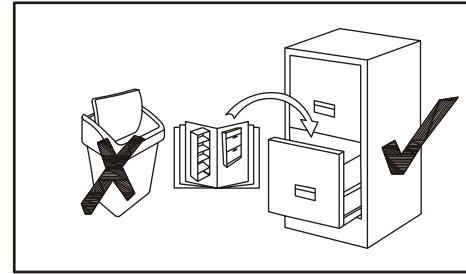
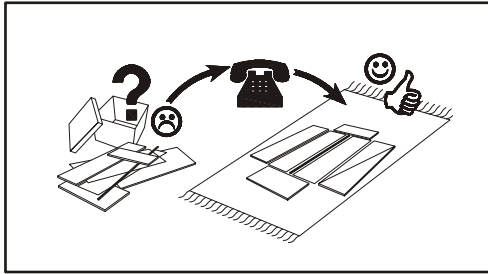
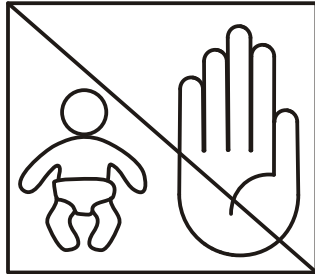

1

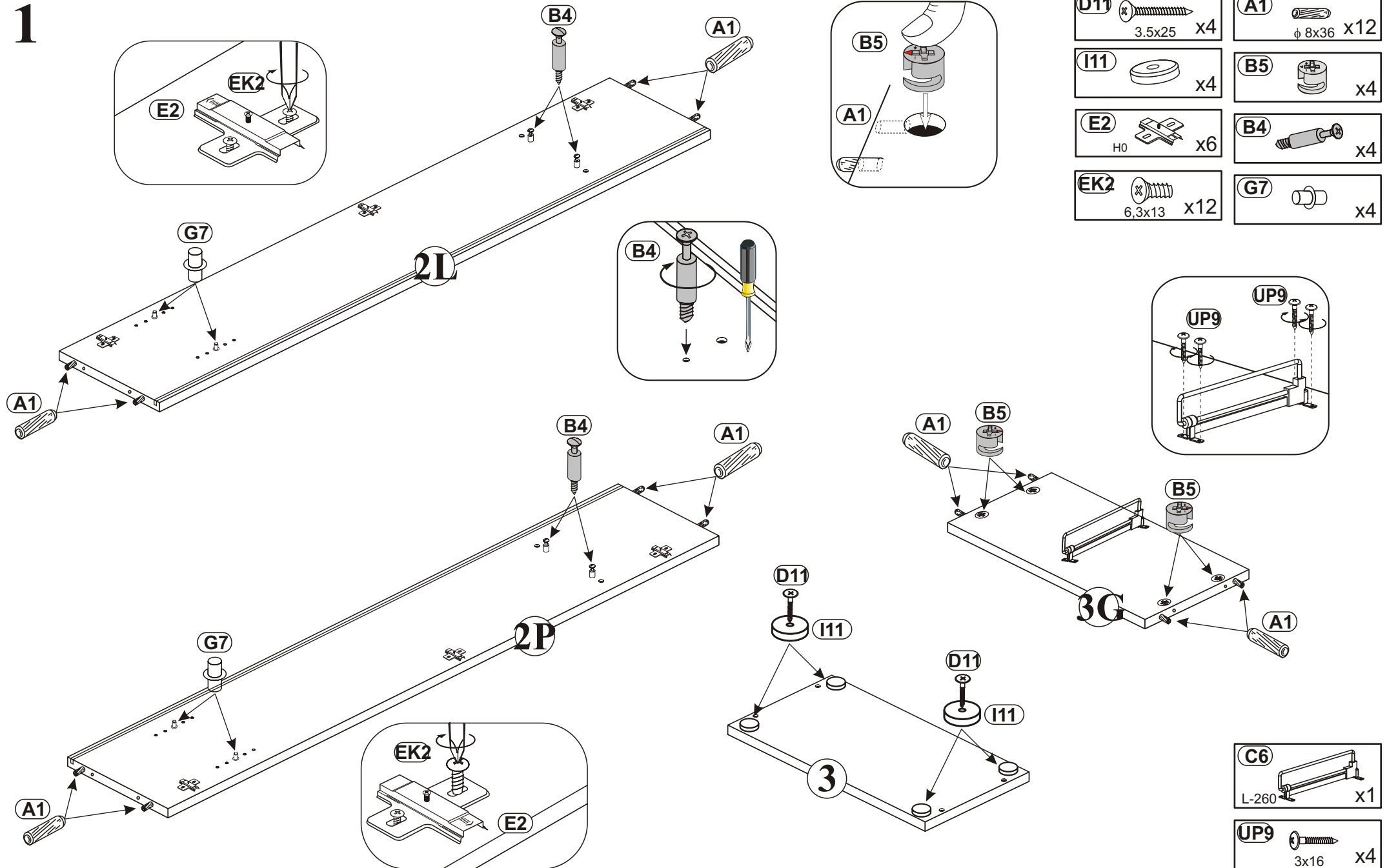

2

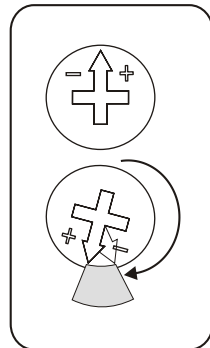
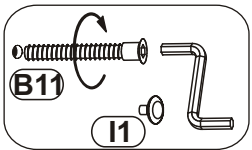
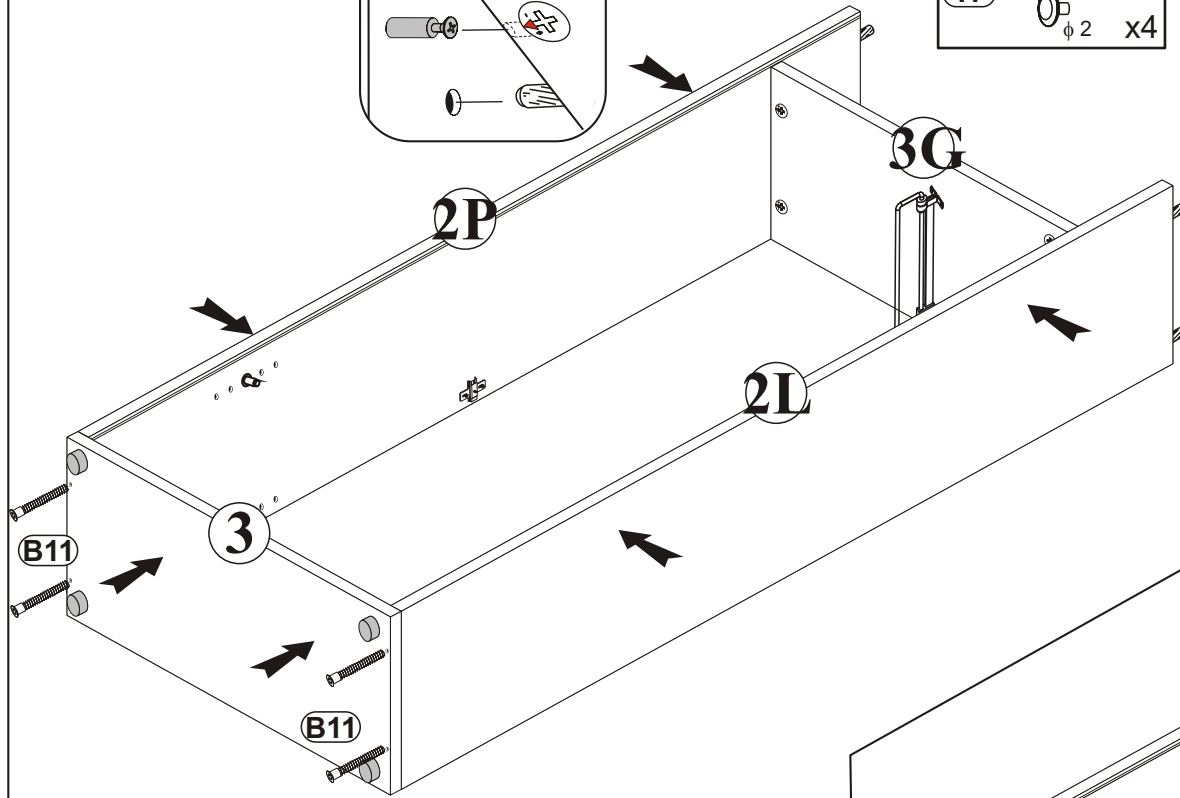
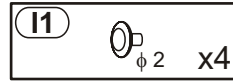
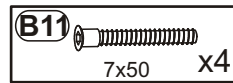
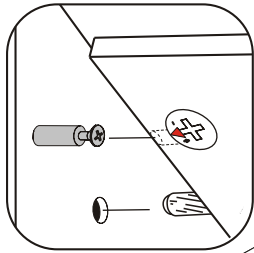

3

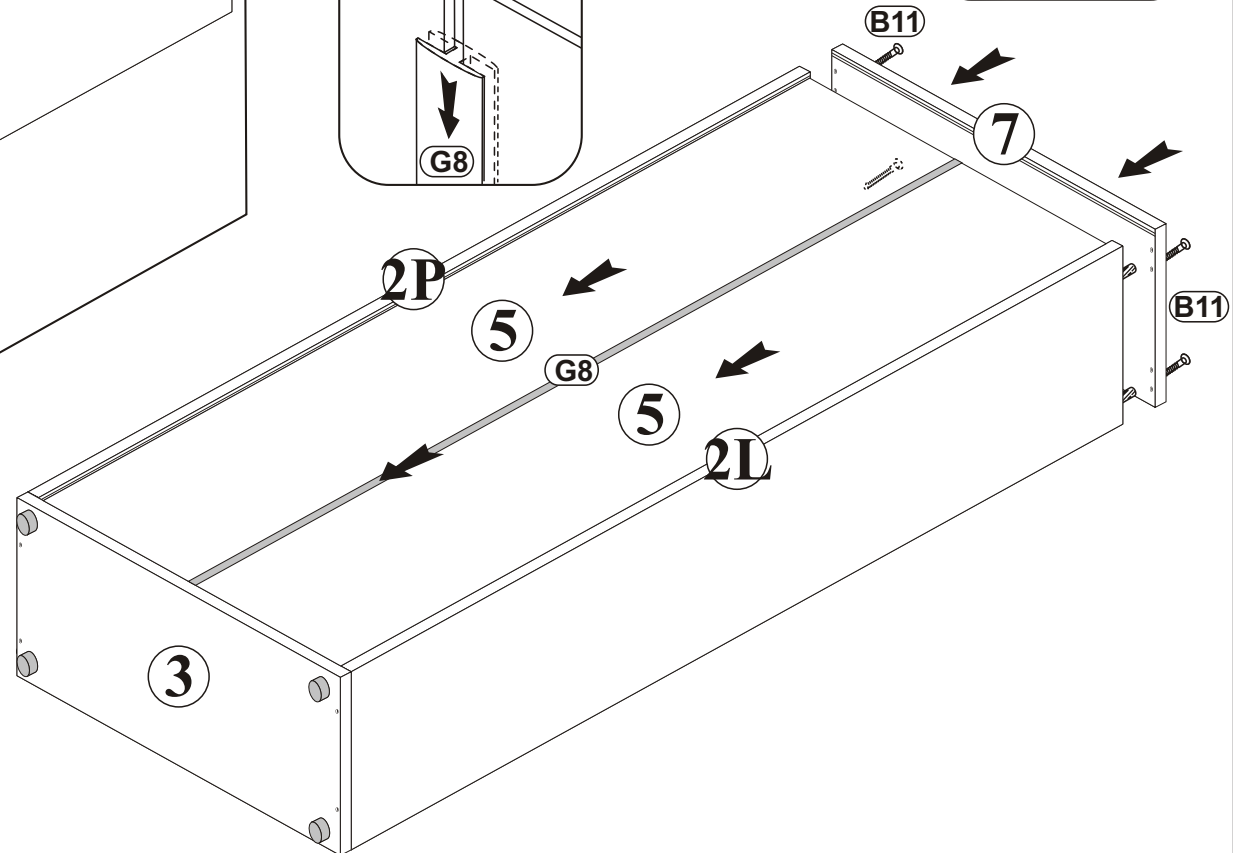
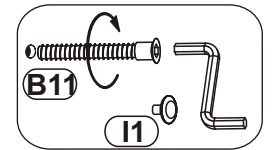
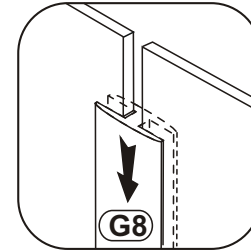
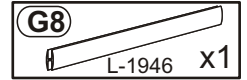
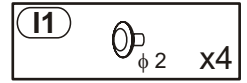
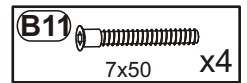

4

S1  x14

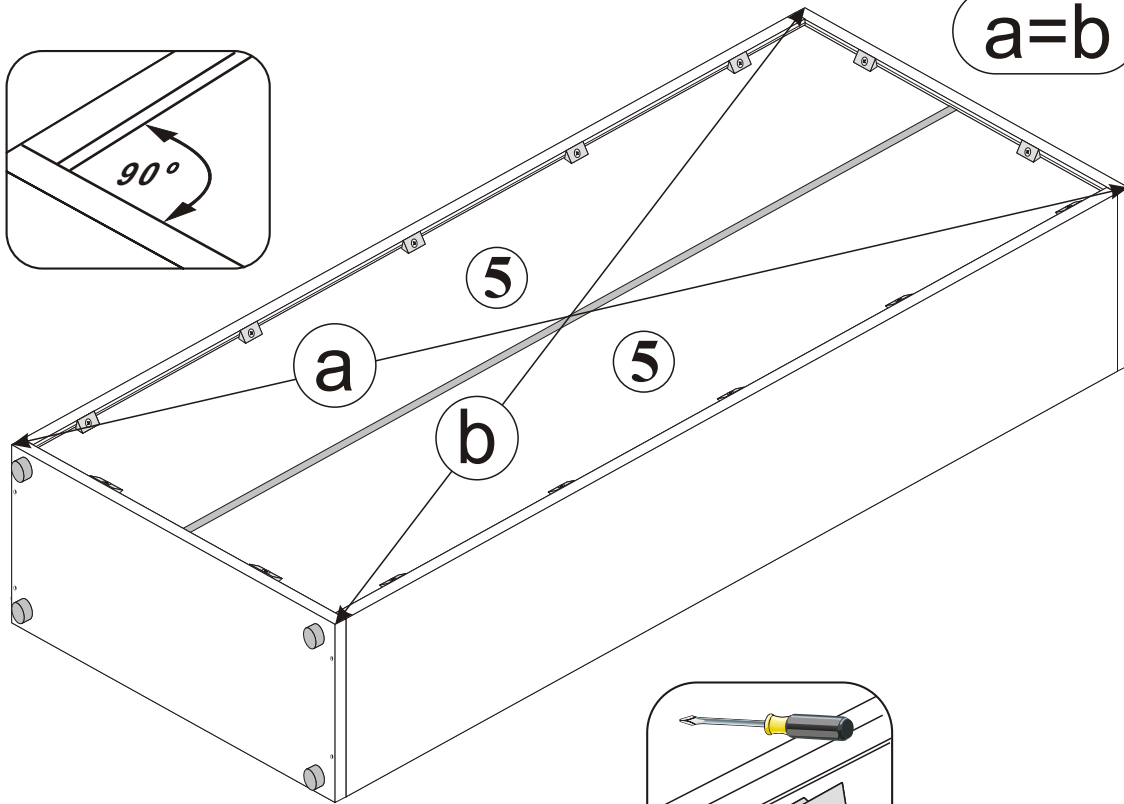
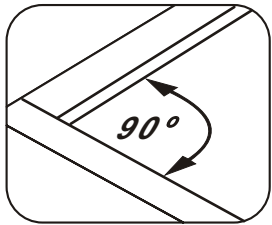



a=b

5

UL  L-224 x1

E1  Kr0 x6

UP6  4x30 x2

D10  3,5x13 x12

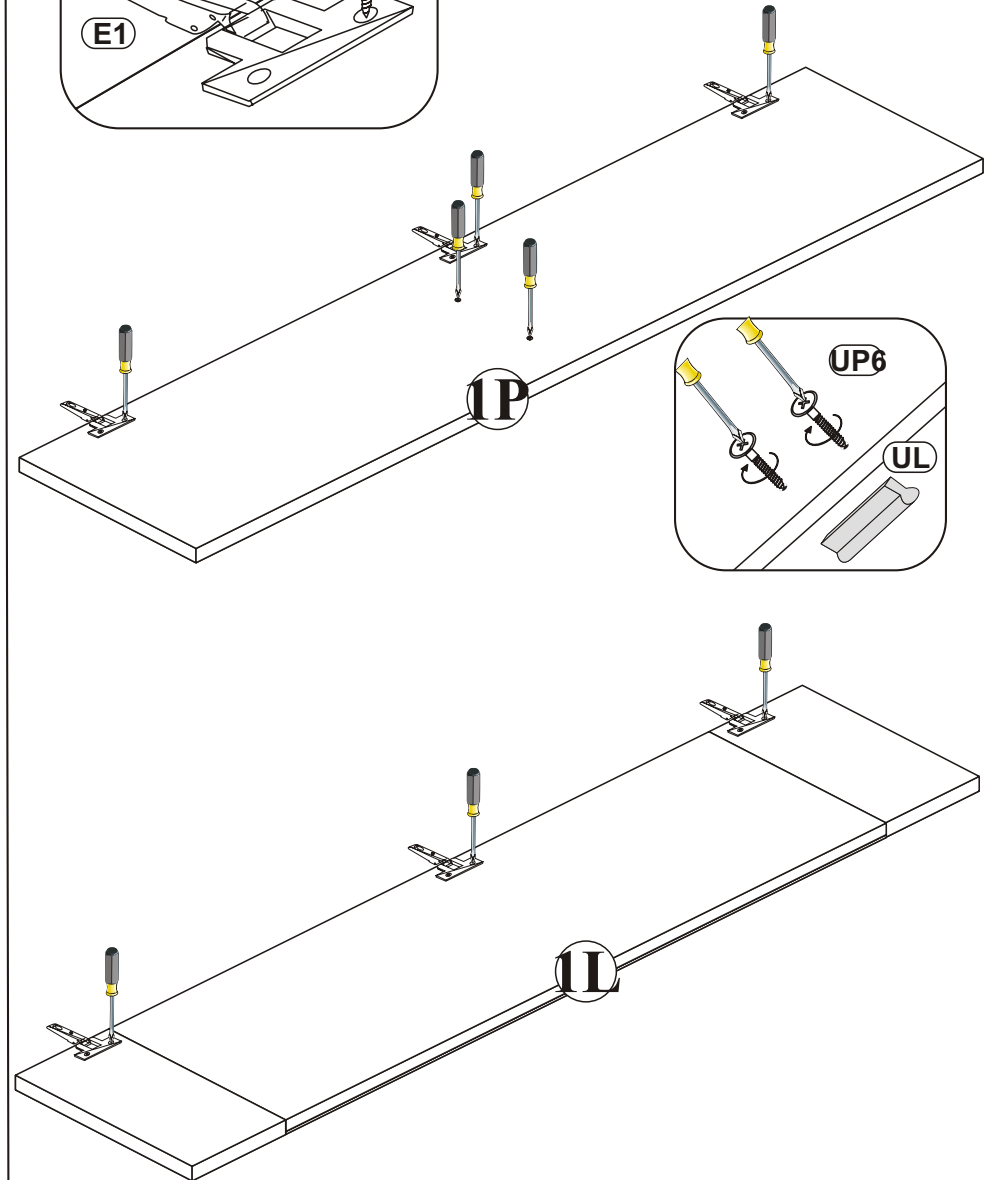
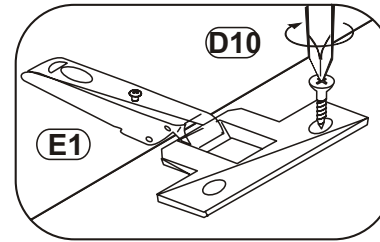

6

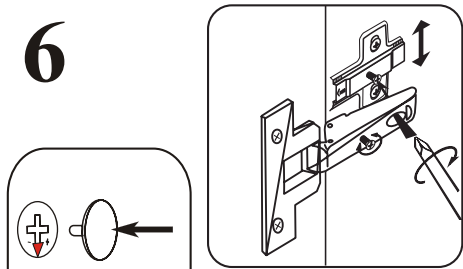

G5
#15 x4

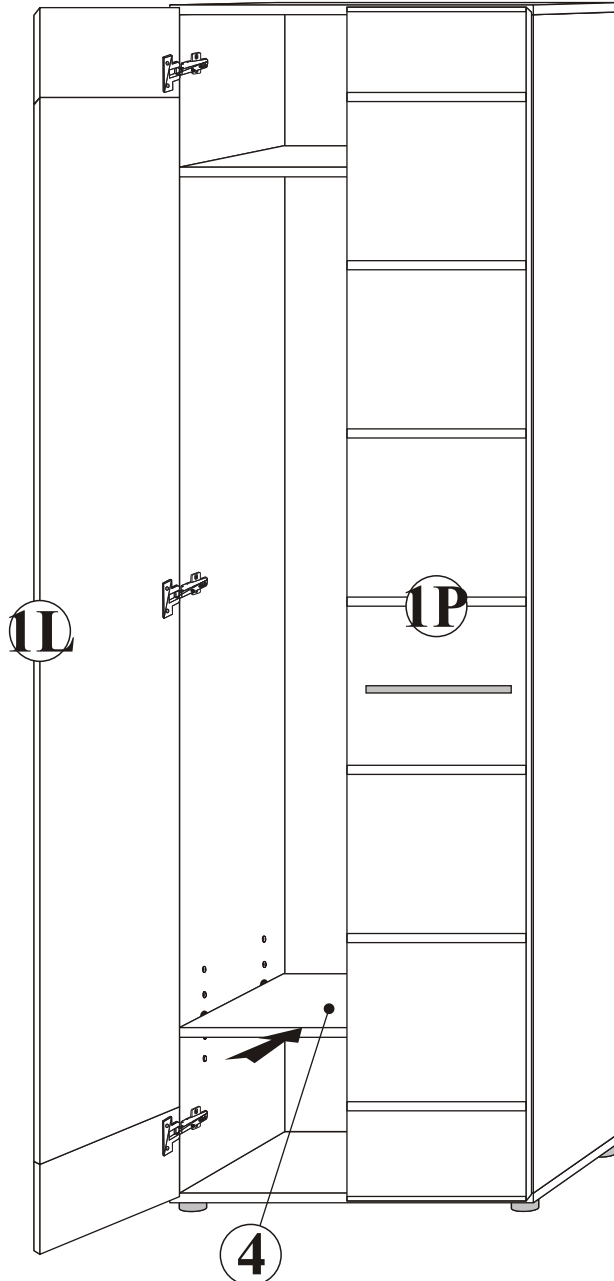

7

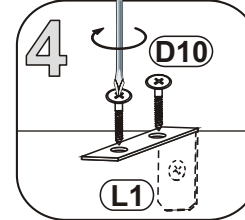
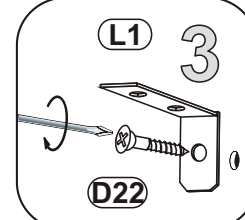
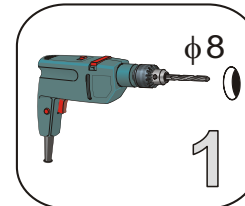

L1 x1

KR2 x1

D22 4x40 x1

D10 3,5x13 x2

