

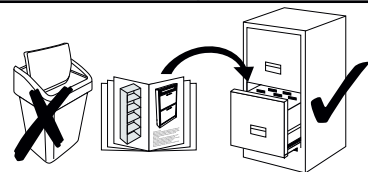

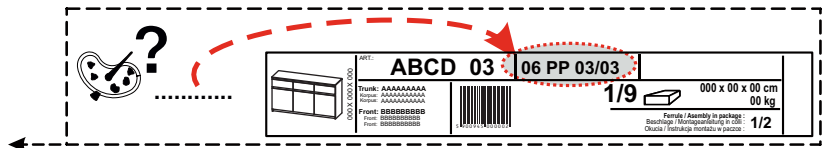

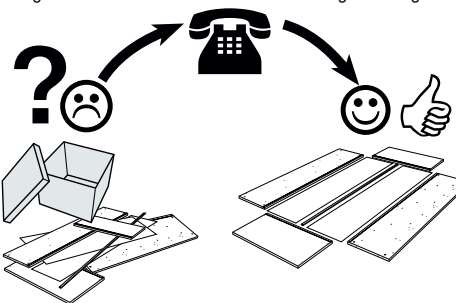



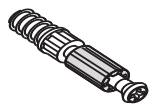

**Service • Assistenza • Dienstverlening • Serwis
Servis • Szerviz • Servizio • Usluga • Сервисная Служба**

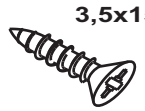
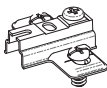
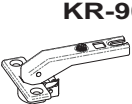
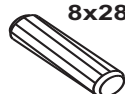
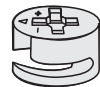
Name • Nom • Nome • Naam • Nazwa Jméno • Názov • Név • Denumire Nombre • Ime • Isim • Название	DAKAR
Nr. • No. • N° • Номер • Č • Sz • Ne	70-638
Typ • Type • Tip • Tipus • Тipo • Тип	

shop • geschäft • boutique • sklep • winkel • магазин
negozio • bolt • tienda • obchod • dučan • magaza • magazin

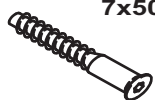

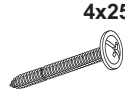
 2x U09	 8x T01	 4x S02
 4x W27	 8x W01	 4x Z06
 4x Z90	 16x D01	 8x T02
 4x E01	 8x C01	 8x R01
 4x W04	 1x K01	 4x W05



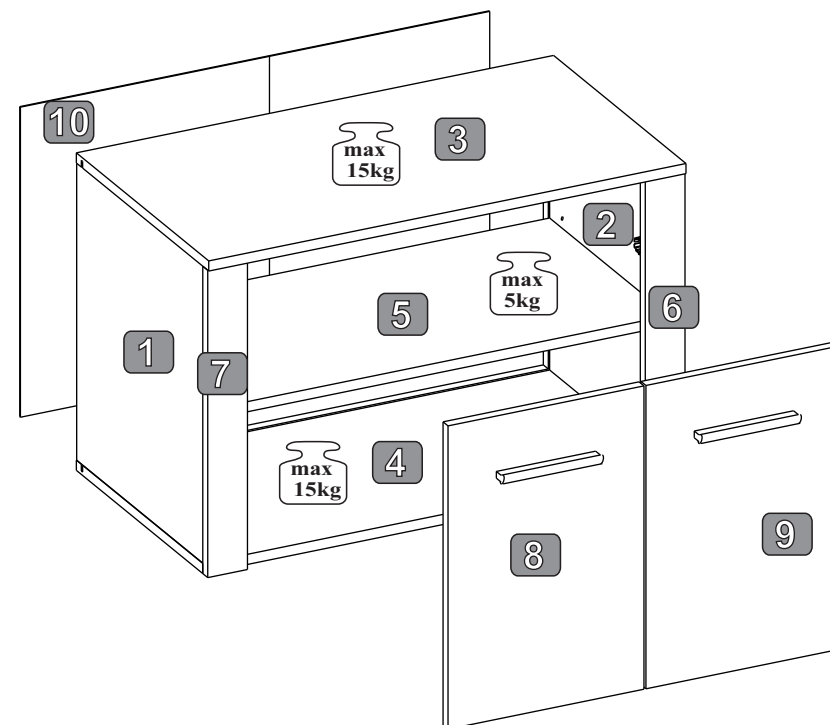





NR	DIM	QTE	COLLI
1	440x382x15	1	1/1
2	440x382x15	1	1/1
3	721x400x15	1	1/1
4	721x382x15	1	1/1
5	690x361x15	1	1/1
6	455x60x15	1	1/1
7	455x60x15	1	1/1
8	449x296x15	1	1/1
9	449x296x15	1	1/1
10	456x709x2	1	1/1

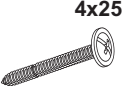

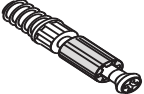
0 10 20 30 40 50 60 70 80 90 100 110 120 130 140 150 160 170 180 190 200

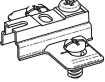

1

 4x25 4x W05	 2x U09	 8x T01	 4x S02	 4x20 4x W27	 3,5x15 8x W01	 4x Z06	 KR-90 4x Z90	 8x28 16x D01
---	---	---	---	---	---	---	--	--

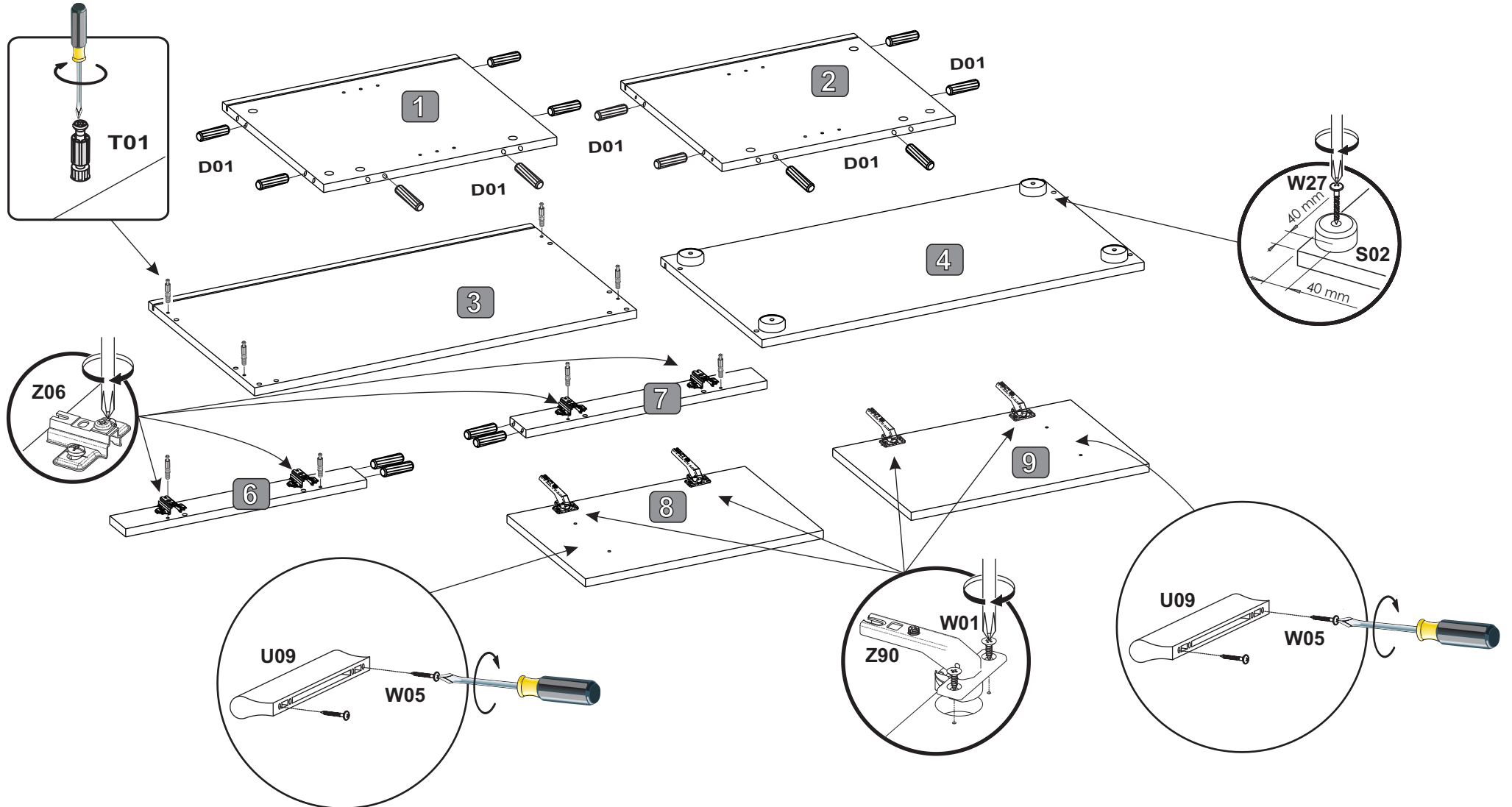

2

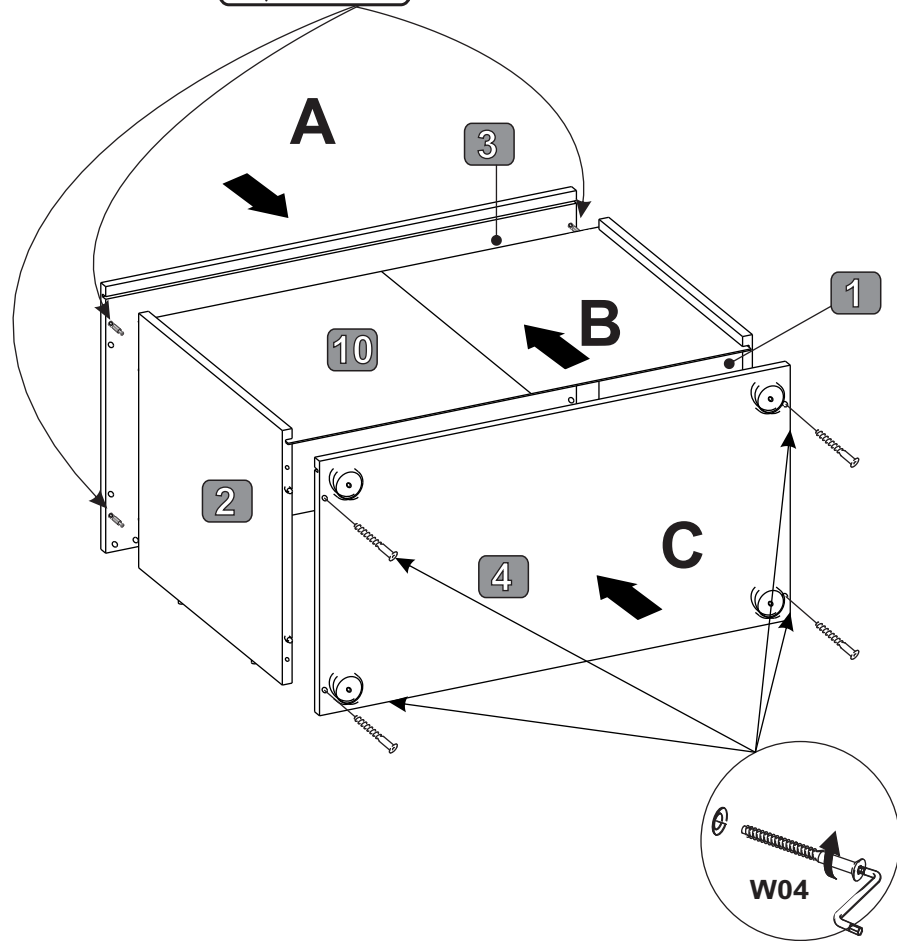
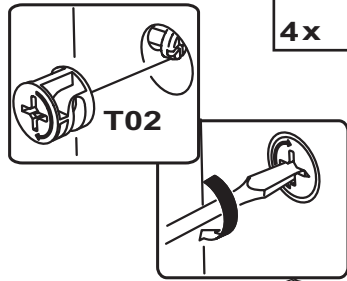
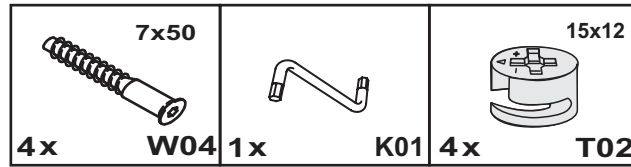

3

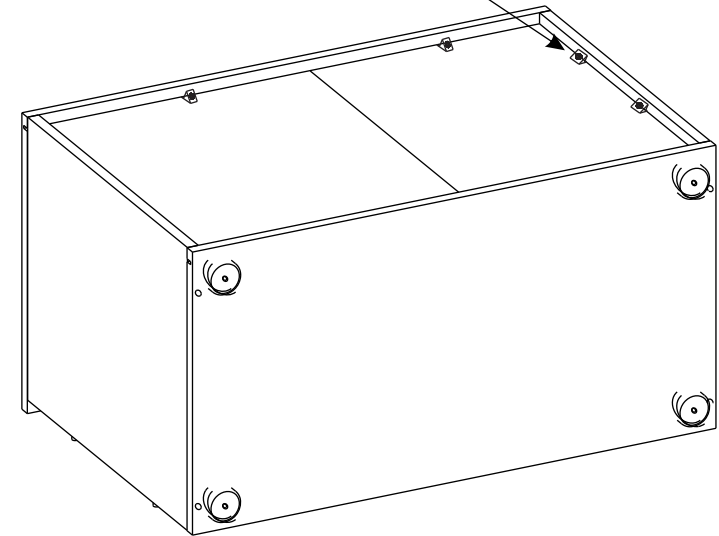
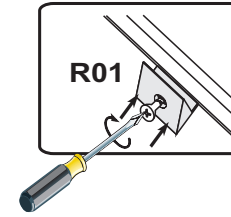
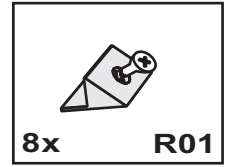

4

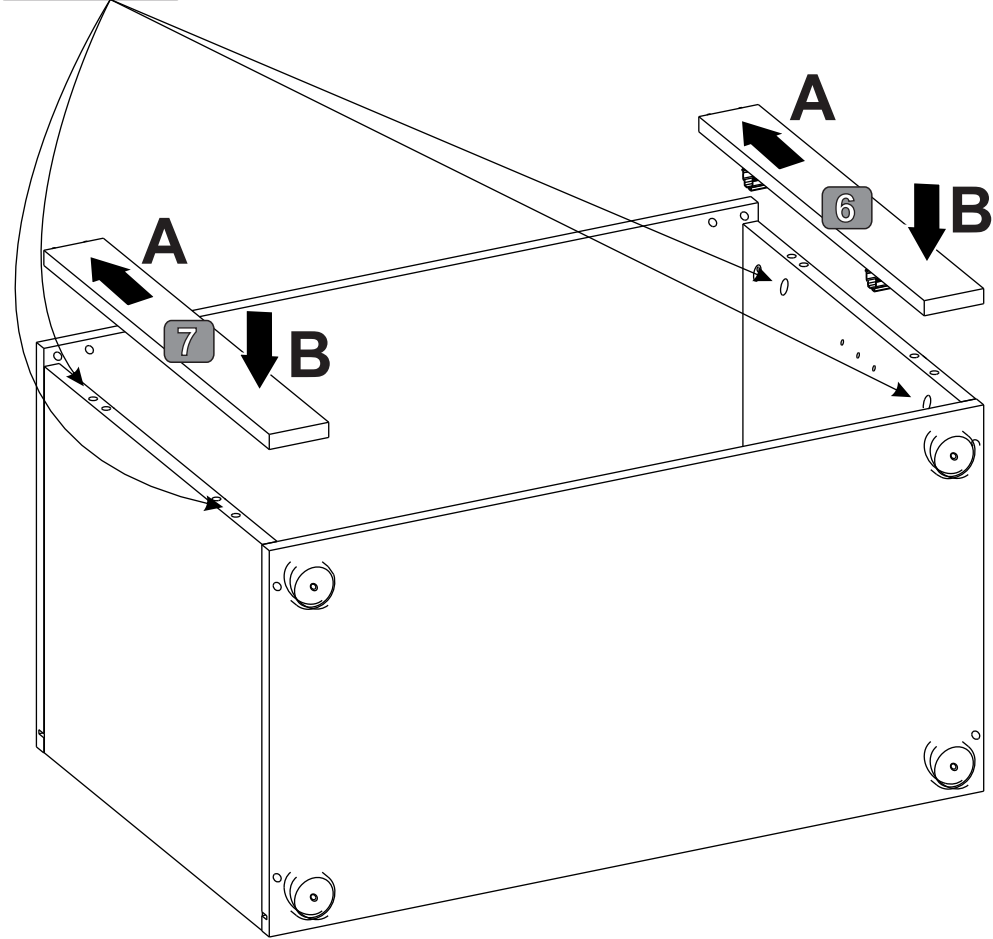
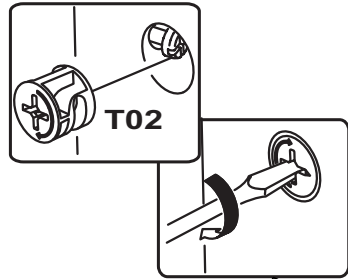
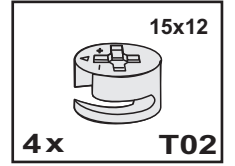

5

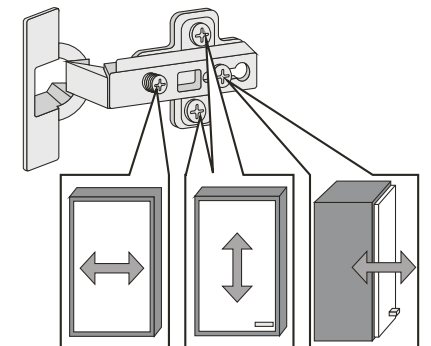
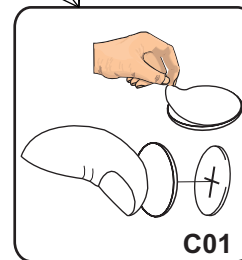
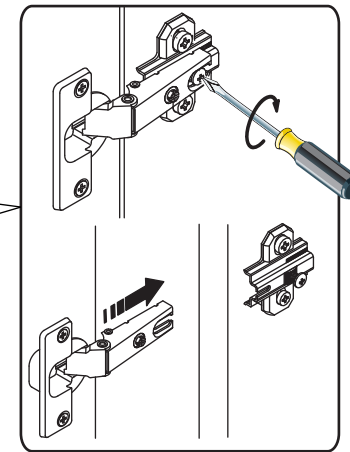
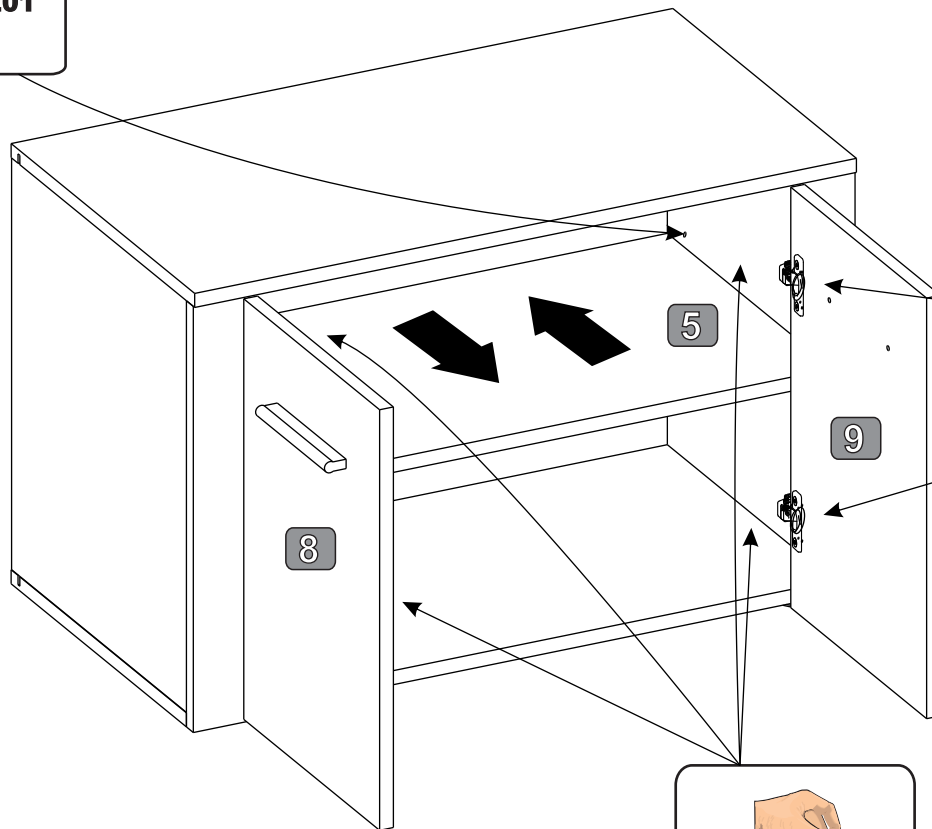
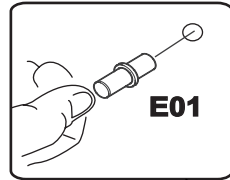
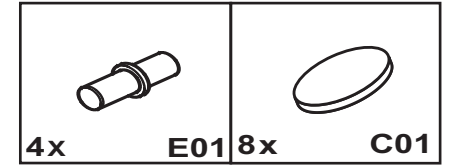

 <p>IT AWERTENZA</p> <p>Se il mobile si ribalta può causare lesioni da compressione serie o fatali. Per prevenire il rischio che il mobile si ribalti, quest'ultimo deve essere fissato permanentemente alla parete.</p> <p>Gli accessori per il fissaggio alla parete non sono inclusi perché pareti di materiali diversi richiedono tipi diversi di accessori di fissaggio. Usa sistemi di fissaggio adatti alle pareti della tua casa. Per maggiori dettagli, rivolgiti a un rivenditore specializzato.</p> <p>Важна информација Пазиљиво прочитајте. Саčuвајте ове упуте за будуће потребе.</p> <p>(HR) UPOZORENJE</p> <p>Ako se namještaj prevrće može doći do ozbiljnih ili smrtonosnih ozljeda. Kako bi izbjegli prevrtanje, namještaj mora biti pričvršćen na zid.</p> <p>Privršnici za zid nisu priloženi s obzirom da različite vrste zida zahtijevaju uporabu različitih vrsta pričvršćivača. Upotrijebite pričvršćivače prikladne za zidove vašeg doma. Za savjet o prikladnim vrstama pričvršćivača kontaktirajte lokalnu specijaliziranu trgovinu.</p> <p>Важна информација Внимательно прочитайте. Сохраните эту информацию.</p> <p>(RU) ВНИМАНИЕ</p> <p>Опрокидывание мебели может привести к серьезным или смертельным телесным повреждениям. Для предотвращения опрокидывания мебель должна быть постоянно прикреплена к стене.</p> <p>Крепёжные средства для крепления к стене не прилагаются. Для разных материалов стен требуются различные крепления. Используйте крепёжные средства, подходящие для материала стен в Вашем доме. Если Вы не уверены, какой тип крепления подходит к данному материалу, обратитесь в специализированный магазин.</p>	<p>Important information Read carefully. Keep this information for further reference.</p> <p>(GB) WARNING</p> <p>Serious or fatal crushing injuries can occur from furniture tip-over. To prevent this furniture from tipping over it must be permanently fixed to the wall.</p> <p>Fixing devices for the wall are not included since different wall materials require different types of fixing devices. Use fixing devices suitable for the walls in your home. For advice on suitable fixing systems, contact your local specialized dealer.</p> <p>Belangrijke informatie Goed lezen Bewaar deze informatie voor toekomstig gebruik</p> <p>(NL) WAARSCHUWING</p> <p>Wanneer meubels omvallen, kan er ernstig of levensbedreigend beklemmingsletsel ontstaan. Om te voorkomen dat dit meubel omvalt, dient dit permanent aan de wand te worden bevestigd.</p> <p>Bevestigingsbeslag voor de wand is niet inbegrepen aangezien verschillende wandmaterialen verschillende soorten bevestigingsbeslag vereisen. Gebruik bevestigingsbeslag dat geschikt is voor de wanden in je huis. Voor advies over geschikt bevestigingsbeslag, neem contact op met de vakhandel.</p> <p>Bitno! Pažljivo pročítajte! Sačuvažajte za ubuduće.</p> <p>(SRB) UPOZORENJE</p> <p>Mogu nastati ozbiljne povrede usled prevrtanja namještaja. Da ovaj namještaj ne bi pao, mora stalno biti pričvršćen za zid.</p> <p>Nisu dati okovi, tiplovi i šrafovi za pričvršćivanje jer se zidovi razlikuju i različiti materijali zahtijevaju i različite okove. Upotrijebite one koji su pogodni za zidove u vašem domu. Za savjet koje okove da upotrijebite, obratite se u lokalnoj govornici.</p> <p>Важна информација Прочетелте внимателно Запазете тази информација за бъдеща справка.</p> <p>(BY) ВНИМАНИЕ</p> <p>Прекартуването на тази мебел може да причини сериозни или фатални наранявания. За да избегнете тази опасност, закрепете здрава за стената.</p> <p>Комплекты не включоуа механизми за прикрепање към стената, тъй като различните стени материјали изискват различни приспособления. Използвайте механизми за прикрепање, подходящи за стените в дома ви. Обърнете към специјализиран търговец за съвет относно подходящи монтажни системи.</p>	<p>Wichtige Information Sorgfältig lesen Diese Information aufbewahren</p> <p>(DE) ACHTUNG</p> <p>Wenn Möbelstücke umkippen, können ernste oder lebensgefährliche Verletzungen durch Einklemmen die Folge sein. Um zu verhindern, dass das Möbelstück umkippt, muss es fest an der Wand verankert werden.</p> <p>Beschläge für die Wandbefestigung sind nicht beigelegt, da sie von der jeweiligen Wandbeschaffenheit abhängig sind. Befestigungsbeschläge benutzen, die für die heimischen Wände geeignet sind. Bei diesbezüglichen Fragen den örtlichen Fachhandel zu Rate ziehen.</p> <p>Informație importantă A lire attentivement. Conservez ces informations pour un usage ultérieur.</p> <p>(FR) AVERTISSEMENT</p> <p>Risque de blessure grave en cas de chute du meuble. Pour éviter que le meuble ne bascule, il faut le fixer au mur de façon permanente.</p> <p>Les fixations ne sont pas incluses car leur choix dépend du matériau du mur sur lequel est fixé le meuble. Utilisez des fixations adaptées au matériau du mur. Pour obtenir des conseils sur les fixations à utiliser, adressez-vous à un revendeur spécialisé.</p> <p>Fontos információ Kerjük, olvassd el alaposan, és orizd meg ezt a papírt!</p> <p>(HU) FIGYELEM</p> <p>A bútor felborulása súlyos, vagy akár végzetes balesetet okozhat. Ahhoz, hogy ezt megakadályozd, a bútort megfelleloen a falhoz kell rögzíteni.</p> <p>A rögzítéshoz szükséges kellekek nincsenek a csomagban, mivel a különböző típusú falakhoz különböző rögzítő eszközökre van szükség. Mindig a fal típusának megfelelő szerelvényeket használj! A megfelelő rögzítők kiválasztásához fordulj szegített a szaküzletek munkatársához!</p> <p>Viktig informasjon Les nøye. Spara informasjonen for framtidig bruk</p> <p>(SE) VARNING</p> <p>Allvariga eller livsfarliga klämskador kan ske om möbel tipsar över. För att förhindra att den här möbeln tipsar måste den fästas permanent vid väggen.</p> <p>Fästbeslag för väggen medföljer inte eftersom olika väggmaterial kräver olika typer av fästbeslag. Använd ett fästbeslag som passar för väggen hemma hos dig. För råd om lämpliga fästbeslag, kontakta din fackhandlare.</p>	<p>Ważne informacje Przezytaj uważnie. Zachowaj ulotkę na przyszłość.</p> <p>(PL) UWAGA</p> <p>Przewrócenie się mebli może doprowadzić do poważnych obrażeń lub śmierci. Aby zapobiec przewróceniu się mebla, należy na stale przymocować go do ściany.</p> <p>W zestawie nie znajdują się żadne śruby mocujące ponieważ różne rodzaje ścian wymagają różnych typów śrub. Użyj śrub odpowiednich do ścian w Twoim domu. W przypadku wątpliwości, jakich śrub użyć, skontaktuj się z najbliższym specjalistycznym sklepem.</p> <p>Informație importantă Citește cu atenție. Păstrează aceste informații pentru referințe ulterioare.</p> <p>(RO) ATENȚIE</p> <p>Pot surveni răni grave dacă te împiedici de obiectele de mobilier. Pentru prevenirea rănilor, fixează mobilierul pe perete.</p> <p>Accesorii de fixare pentru perete nu sunt incluse deoarece materialele diferite din care sunt făcuți pereții au nevoie de accesorii diferite de fixare. Folosește accesorii de fixare potrivite pentru pereții camerei tale. Contactează un specialist dacă nu știi care sunt accesoriile potrivite pentru casei tale.</p> <p>Importante! Ler estas instruções cuidadosamente. Guardar como referência.</p> <p>(PT) IMPORTANTE</p> <p>As quedas de móveis podem originar esmagamento ou morte. Estes móveis devem ser fixados a parede para evitar possíveis quedas.</p> <p>Os diferentes tipos de parede requerem diferentes tipos de ferragens. Utilize ferragens adequadas as paredes da sua casa (não incluídas). Se não tiver a certeza do tipo de parafusos ou ferragens a usar, consulte uma loja de ferragens.</p> <p>Viktig informasjon Les nøye. Ta vare på denne informasjonen for fremtidig bruk.</p> <p>(NO) ADVARSEL</p> <p>Alvorlige ulykker kan skje som følge av møbler som veltet. For å forhindre at dette møbelet faller, må det festes permanent til veggen.</p> <p>Festemidler for vegg er ikke inkludert fordi ulike vegger krever ulike festemidler. Bruk festemidler som passer til veggene i hjemmet ditt. Kontakt din nærmeste faghandel for råd om festemidler.</p>	<p>Důležitá informace Čtěte pečlivě. Uchovejte ji pro pozdější použití.</p> <p>(CZ) VAROVÁNÍ</p> <p>Pokud se nábytek převrhne, může dojít k velmi vážným nebo dokonce fatálním poraněním. Abyste předešly nábytku zabránění, musíte ho natrvalo připevnit ke stěně.</p> <p>Upevňovací materiál není součástí balení, protože se liší v závislosti na materiálu stěny. Použijte tedy takový upevňovací materiál, který je vhodný na stěny u vás doma. Pokud se potřebujete poradit, obraťte se na místního odborníka.</p> <p>Önemli bilgi Dikkatli okuyunuz Bu klavyzu ilerde gerekebileceği için saklayınız.</p> <p>(TR) UYARI</p> <p>Mobilyanın devrilmesi sonucunda ölümcül veya ciddi yaralanmalara meydana gelebilir. Devrilme riskini önlemek için mobilyanın duvara sabitlenmesi gerekmektedir.</p> <p>Duvar yapı malzemesi farklılık gösterebileceğinden, mobilyanın duvara sabitlenmesi için gereken baglantı parçaları ürüne dâhil değildir. Evimizin duvar yapı malzemesine uygun baglantı parçalarını seçiniz. Duvar yapı malzemesine uygun baglantı parçalarını satın almak için en yakın yapı market ya da bir malzeme dükkanından bilgi alabilirsiniz.</p> <p>Важлива інформація Прочитайте уважно Збережіть цю інструкцію</p> <p>(UA) УВАГА</p> <p>Падіння незакріплених меблів може спричинити серйозне або смертельне травмування людини. Щоб запобігти перевірданню цих меблів, їх слід міцно прикріпити до стіни.</p> <p>Кріплення до стіни не додаються, оскільки різні матеріали потребують різних кріплень. Використовуйте кріпильні пристрої, які пасують матеріалу Ваших стін. За порадою щодо належних систем кріплення звертайтеся у місцеву спеціалізовану крамницю.</p> <p>Tärkeä tieto Lue huolellisesti. Sästä mahdollista myöhempää tarvetta varten.</p> <p>(FI) VAROITUS</p> <p>Huonekalun kaatuminen voi aiheuttaa vakavia tai kuolemaan johtavia vammoja. Kaatumisen estämiseksi huonekalu tulee kiinnittää ruuvuavasti seinään.</p> <p>Rakkaus ei sisällä seinään kiinnittämistä varten tarvittavia ruuveja ja tulppia, koska erilaisia seinämateriaaleja varten tarvitaan erilaiset kiinnikkeet. Valitse kiinnikkeet kotisi seinämateriaalin mukaan. Arpa oikeanlaisen kiinnikkeen valintaan voit kysyä rautakaupasta.</p>	<p>Dôležitá informácia! Čítajte pozorne. Informácie si uschovajte pre prípad potreby.</p> <p>(SK) UPOZORNENIE</p> <p>Prevrhnutie nábytku môže spôsobiť veľmi vážne zranenia. Aby sa predišlo prevrhnutiu nábytku, upevnite ho ku stene.</p> <p>Upevňovací materiál nie je súčasťou balenia, pretože na každý materiál steny je potrebné použiť iný typ skrutky a hmoždinky. Použite upevňovací materiál vhodný na konkrétny typ materiálu, z ktorého je vaša stena vyrobená. V prípade potreby sa poraďte s odborníkom.</p> <p>Informație importantă Leer detenidamente. Guarda esta información para consultarla en el futuro.</p> <p>(ES) ADVERTENCIA</p> <p>Pueden producirse lesiones graves o fatales si vuelca un mueble. Para evitar que vuelque este mueble, debe fijarse permanentemente a la pared.</p> <p>No se incluyen los dispositivos de fijación, dado que los diversos materiales de pared requieren diferentes tipos de herrajes de fijación. Usa herrajes adecuados para el material de las paredes de tu casa. Para saber cuáles son los herrajes adecuados, pide consejo en tu ferretería habitual.</p> <p>Viktig oplysninger! Les omhyggeligt. Gem disse oplysninger til senere brug.</p> <p>(DK) ADVARSEL</p> <p>Der kan opstå alvorlig eller livsfarlig tilskadekomst, hvis møbel veltet. For at undgå at møbel veltet, skal det fastgøres permanent til væggen.</p> <p>Forskellige vægmateriale kræver forskellige skruer og råvplugs. Medfølger ikke. Brug skruer og råvplugs, der passer til væggen i dit hjem. Hvis du er i tvivl om, hvilken type skruer/råvplugs du skal bruge, skal du kontakte et byggemarked.</p> <p>Σημαντική πληροφορία Διαβάστε προσεκτικά Φυλάξτε αυτή την πληροφορία για μελλοντική αναφορά.</p> <p>(GR) ΠΡΟΕΙΔΟΠΟΙΗΣΗ</p> <p>Σοβαροί ή μοιραίοι τραυματισμοί από σύνθλιψη, ύποβορνη ή σύρσιμο από το αναποδογύρισμα επίπλων. Για να προληφθείτε το αναποδογύρισμα ενός επίπλου, αυτό θα πρέπει να είναι ροιμια στερεωμένο στον τοίχο.</p> <p>Τα έπιπλα/μπατα στερεωθούν στον τοίχο δεν περιλαμβάνονται, δεδομένου ότι τα διαφορετικά υλικά τοίχων απαιτούν και διαφορετικούς τύπους εξαρτημάτων στερέωσης. Χρησιμοποιήστε εξαρτήματα στερέωσης κατάλληλα για τους τοίχους του σπιτιού σας. Για πληροφορίες σχετικά με τα κατάλληλα εξαρτήματα στερέωσης, συμβουλευθείτε το ειδικό κατάστημα της περιοχής σας.</p>
---	---	--	---	--	--

(GB)**Instructions for furniture maintenance**

- The maintenance consists in regular cleaning the external and internal surfaces of the furniture.
- Remove any stains or dirt regularly. The fresh stains are usually to be removed easier and completely
- Materials and agents for maintenance:
- RECOMMENDED** : soft fabric cloths while using proper cleaning and maintenance agents (it is recommended to apply commonly used foams and emulsions) however, before using them it is advisable to do the test on the invisible surface with the agents designed for using for this type of material
- UNACCEPTABLE** : rough sponges, scratchers, detergents, chemical solvents, polishes powders containing abrasive materials and it is also inadvisable to soak with a great amount of water.

(DE)**Anweisung zur Möbelpflege**

- Pflege bedeutet regelmäßige Reinigung der äußeren und inneren Möbeloberfläche
- Flecken und Verschmutzungen laufend entfernen. Neue Flecken lassen sich gewöhnlich leicht und häufig völlig entfernen
- Pflegestoffe und -mittel:
- EMPFEHLENSWERT** : Lappen aus weichem Stoff und entsprechendes Reinigungsmittel (empfehlenswert sind handelsübliche Schäumen und Emulsionen) allerdings wird vor der Anwendung der Reinigungsmittel ein Test auf der unsichtbare Oberfläche empfohlen
- UNZULÄSSIG**: harte Schwämme, Schrubber, Spülmittel, chemische Lösungsmittel, Pasten Pulver mit Schleifmittel sowie Nassmischen mit viel Wasser.

(FR)**Indications concernant la conservation des meubles**

- La conservation consiste à un nettoyage régulier des surfaces externes et internes du meuble.
- Effacer les taches et les salures immédiatement. D'habitude, les taches fraîches sont plus faciles à effacer.
- Les matériaux et les substances destinés pour la conservation:
- RECOMMANDÉS** : les chiffons mous, en utilisant les moyens convenables destinés pour nettoyer et conserver les meubles (il est recommandé d'utiliser les crèmes et émulsions accessibles au marché) pourtant, avant d'utiliser un liquide, il est recommandé de faire un test sur une surface invisible avec des liquides destinés pour ce type de matériau
- INADMISSIBLES** : éponges dures, radiaires, détergents, dissolvants chimiques, pâtes-poudres contenant les substances abrasives, il n'est recommandé non plus de mouiller les meubles avec de l'eau.

(NL)**Aanwijzing voor het onderhoud van meubels**

- Het onderhoud houdt het regelmatig reinigen van de meubels in.
- Verwijder steeds vlekken en vuil. Versne vlekken zijn gewoonlijk gemakkelijker en vaak in hun geheel te verwijderen.
- Onderhoudsmaterialen en -middelen:
- AANBEVOLEN**: doeken van zachte stof met reinigingsmiddelen (het gebruik van algemeen verkrijgbare schuim en emulsies wordt aanbevolen). Voer voor het gebruik van de reinigings- en onderhoudsmiddelen een test uit op een onzichtbare plaats met middelen die bestemd zijn voor dat soort materiaal.
- AFGERADEN**: harde sponzen, krabbers, detergenten, chemische oplosmiddelen, pasta's en poeders die schuwmiddelen bevatten. Het wordt ook afgeraden om grote hoeveelheden water te gebruiken.

(IT)**Indicazioni relative alla conservazione dei mobili**

- La conservazione consiste in una pulizia sistematica delle superfici interne ed esterne dei mobili.
- Togliere le macchie e sporchie immediatamente poiché lo sporco fresco solitamente ed interamente è più facile da eliminare.
- Pulire le macchie e sporchie immediatamente poiché lo sporco fresco solitamente ed interamente è più facile da eliminare.
- SI RACCOMANDA**: stracci di tessuto morbido con aggiunta di adeguati prodotti per la pulizia e conservazione (si raccomanda l'utilizzo di schiume ed emulsioni generalmente accessibili nel commercio). Tuttavia, prima di applicare tali prodotti, scelti in base alla superficie da trattare, occorre eseguire il test su una zona meno visibile.
- SONO VIETATI**: spugne dure, raschiatori, detergenti, paste e polveri contenenti sostanze abrasive. Inoltre, è da evitare di bagnare i mobili con l'acqua.

(HU)**Bűtor ápolására vonatkozó útmutatók**

- Az ápoláshoz a bűtor külső és belső felületének rendszeres tisztítása tartozik.
- Folyamatosan kell a foltokat és a szennyeződéseket eltávolítani. A friss foltok általában könnyebben és gyakran teljesen eltávolíthatók.
- Ápolási anyagok és szerek:
- JAVASOLT**: a tisztításhoz puha rongyot (ruhát) és megfelelő ápolási szereket használnunk (javasolt a kereskedelemben elérhető habok és emulziók használata) a tisztító-ápolási szerek használata előtt a nem látható (nem szembetűnő) felületen adott szerrel egy próbatesztet kell elvégezni.
- TILLOS**: a kemény szivacs, kaparó, mosószernek, vegyi oldószerek, surólószereket tartalmazó porok és paszták használata, a tisztításhoz nem szabad nagy mennyiségű vizet használni és abban zdatni.

(ES)**Indicaciones para conservación de los muebles**

- La conservación consiste en la limpieza corriente de las superficies externas e internas del mueble.
- Quite las manchas y suciedades según vayan apareciendo. Las manchas recientes suelen quitarse ligera y completamente.
- Materiales y productos para conservación:
- SE RECOMIENDAN**: trapo de tela suave con la utilización de los productos correspondientes de limpieza y conservadores (se recomiendan las espumas y emulsiones disponibles en el mercado). No obstante, antes de usar el producto de limpieza y conservador se recomienda hacer una prueba en la superficie invisible con los productos apropiados para este tipo de materia.
- NO SE ADMITE EL USO DE**: esponjas duras, metálicas, detergentes, disolventes, cremas, polvos que contienen agentes abrasivos. Tampoco se puede mojar el mueble con demasiada cantidad de agua.

(PL)**Wskazówki na temat konserwacji mebli**

- Konserwacja polega na regularnym czyszczeniu zewnętrznych i wewnętrznych powierzchni mebla.
- Na bieżąco usuwać plamy i zabrudzenia. Świeże plamy dają się najłatwiej usunąć w całości.
- Materiały i środki do konserwacji:
- ZALECANE**: ściereczki z miękkiej tkaniny z użyciem odpowiednich środków czyszcząco - konserwujących (zaleca się stosowanie ogólnie dostępnych pianek i emulsji) jednak przed użyciem środków czyszcząco - konserwujących zaleca się przeprowadzenie testu na powierzchni niewidocznej nieodcznej próbkami przeznaczonymi dla tego typu tworzywa
- NIEDOPUSZCZALNE**: twarde gąbki, drapak, deterenty, rozpuszczalniki chemiczne, pasty proszki zawierające środki ściernie oraz niewskazane jest moczenie duża ilością wody.

(CZ)**Pokyny pro údržbu nábytku**

- Údržba spočívá v pravidelném čištění vnějších a vnitřních povrchů nábytku.
- Škvrny a nečistoty okamžitě odstraňujte. Čerstvé škrny je možné snadněji a nejčastěji zcela odstranit
- Materiály a prostředky k údržbě:
- DOPORUČENÉ**: hadičky z měkké látky s použitím vhodných čisticích a konzervačních prostředků (doporučuje se používat všeobecné přístupných pěnek a emulzí) avšak před použitím čisticích a konzervačních prostředků (doporučuje se doporučit test na neviditelné části, a to prostředky určenými pro tento typ látky.
- NEDOVOLENÉ**: tvrdé hubky, škrábky, deterenty, chemické rozpouštědla, pasty prášky obsahující brusné prostředky a nedoporučuje se močit příliš velkým množstvím vody.

(SK)**Pokyny pre údržbu nábytku**

- Údržba spočíva v pravidelnom čistení vonkajších a vnútorných povrchov nábytku.
- Škvrny a nečistosti okamžite odstraňujte. Čerstvé škvrny môže sa ľahko a najčastejši celkom odstrániť.
- Materiály a prostriedky na údržbu:
- ODPORUČENÉ**: handričky z mäkkej látky s použitím vhodných čisticích konzervačných prostriedkov (odporčuje sa používať všeobecne prístupných pen a emulzií) avšak pred použitím čistiaci a konzervačných prostriedkov (odporčuje sa doporučiť test na neviditeľnej časti, a to prostriedkami určenými pre tento typ látky
- NEDOVOLENÉ**: tvrdé hubky, škrabáky, deterenty, chemické rozpúšťadla, pasty prášky obsahujúce brusné prostriedky a neodporčuje sa močiť príliš veľkým množstvom vody.

(HR)**Savjeti za Održavanje namještaja**

- Održavanje se sastoji od redovitih čišćenja vanjskih i unutarnjih površina namještaja.
- Redovito uklanjati mrlje i prljavštine. Svježe mrlje mogu biti lakše i najčešće u potpunosti uklonjene.
- Materijali i sredstva za održavanje:
- PREPORUČAMO**: korištanje krpica od mekih tkanina i odgovarajuća sredstva za čišćenje i održavanje (preporuča se koristiti pjene i emulzije dostupne u prodaji) - ali prije nego počnete koristiti sredstva za čišćenje i održavanje, preporučljivo je provesti test tog sredstva na nevidljivoj površini materijala.
- NEDOVOLJENA SREDSTVA**: tvrda spužva, grebalice, deterženti, hemijska otopila, sredstva u obliku pasti ili praška, koja sadrže abrazivna sredstva, ne preporuča se namakanje velikim količinama vode.

(TR)**Mobilya bakım talimatı**

- Mobilya bakımı, mobilyanın iç ve dış yüzeylerinin muntazam bir biçimde temizlenmesinden oluşur.
- Oluşan lek ve kirlemelerin derhal giderilm. Taze lekeler genellikle kolay ve tümyle çıkar.
- Mobilya bakım malzeme ve araçları
- TAVSİYELER**: yumuşak bez ve uygun temizleme-bakım araçları (piyasadaki köpük ve emülsiyonlar) tavsiye edilir. Aslı temizlemeye geçmeden önce kullanacağıınız ilacı mobilyanın görünmeyen yüzeyinde test etmeyi ihmal etmeyiniz.
- UYARI**: sert sünger, tel sünger, tiner, çizici özelliği olan deterjan, toz deterjan asla kullanmayın. Mobilya yüzeylerini fazla ıslatmayın

(RO)**Ștaturi pentru întreținerea mobiliei**

- Întreținerea constă în curățarea regulată a suprafețelor exterioare și interioare ale mobilierului.
- Petele și murdăria trebuie să îndepărtate imediat. De obicei, petele proaspete pot să fie mai ușor și complet eliminate.
- Materiale și detergenți de întreținere:
- RECOMANDATE**: ștergere cu o cârpă moale, și utilizarea unor detergenți pentru curățare și întreținere (este recomandat să utilizezi spume disponibile în comerț și emulsii), cu toate acestea, înainte de aplicarea detergenților pentru curățare-întreținere, se recomandă să se efectueze testul pe o suprafață disponibilă învizibilă din acest tip de material
- NICIODATĂ**: bureți duri, lavete abrazive, detergenți, solvenți, substanțe chimice, pulberi, paste care conțin substanțe abrazive; nu este recomandată nici umezirea cu o cantitate mare de apă

(RU)**Рекомендации по уходу за мебелью**

- Уход за мебелью предусматривает регулярную протирку внешней и внутренней поверхности мебели.
- Пятна и загрязнения снимают сразу же. Свежие пятна удаляются легче и зачастую полностью.
- Материалы и средства по уходу:
- РЕКОМЕНДУЕМЫЕ**: тряпочки из мягкой ткани с применением соответственных чистяще-консервирующих средств (рекомендуется применение общедоступных пенки и эмульсий). Однако, перед применением чистяще-консервирующего средства следует провести тест на скрытой поверхности мебели.
- НЕ РЕКОМЕНДУЕМЫЕ**: жесткие губки, наждаки, deterгенты, химические растворители, пасты и порошки с содержанием абразивных веществ. Не допускать скопления воды на поверхности мебели.