

option :A

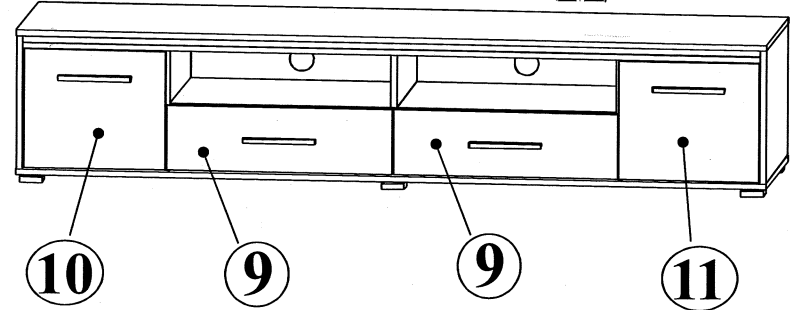

option :B

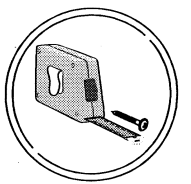
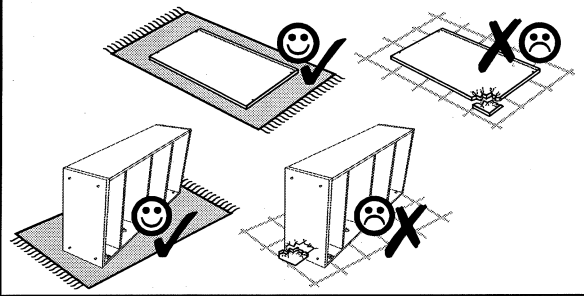
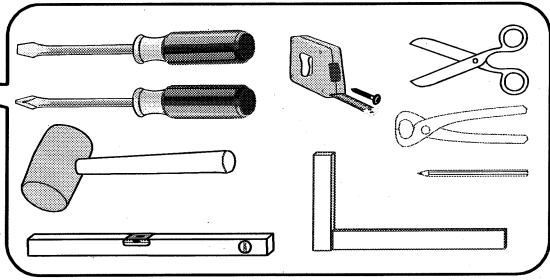
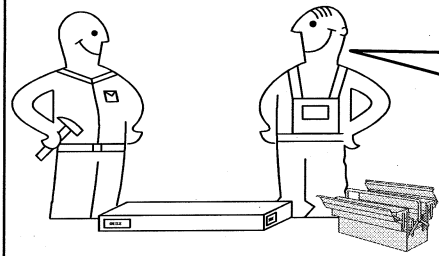
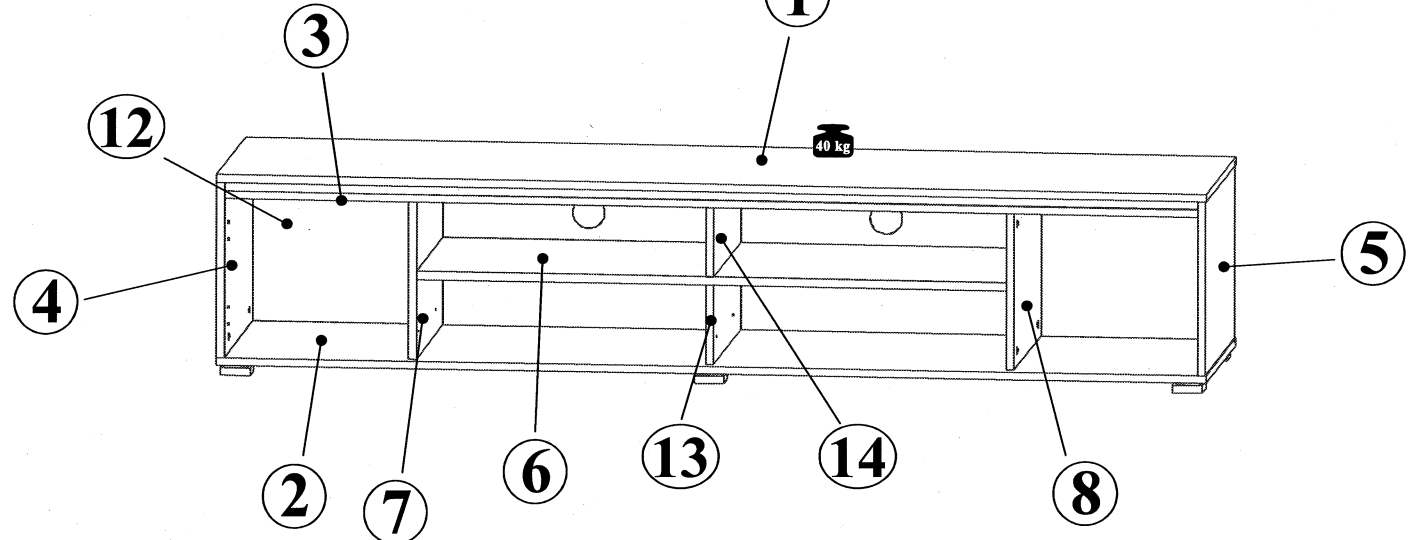
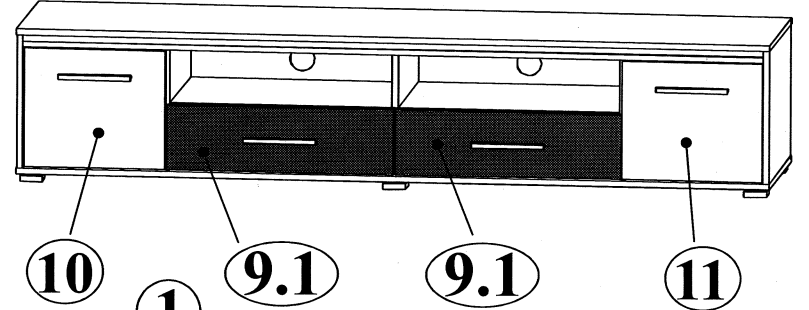

**2**

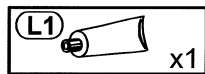
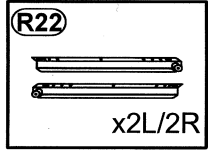

option :A

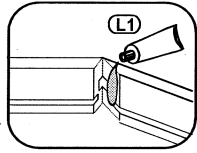

option :B

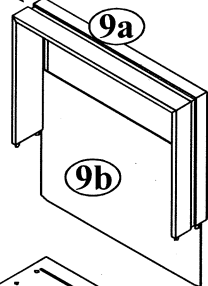
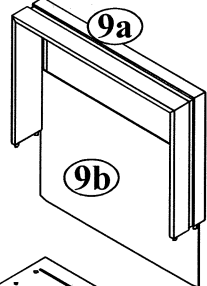

x2

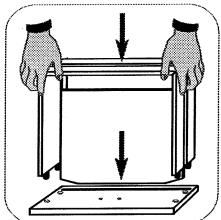
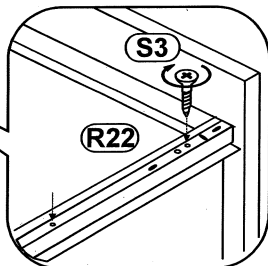
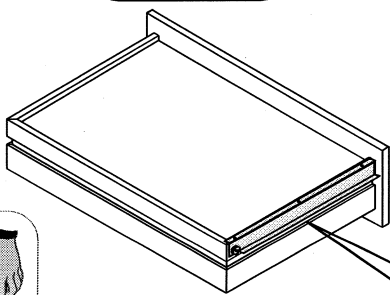
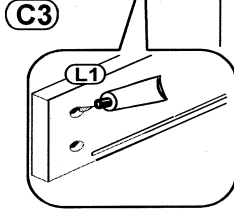
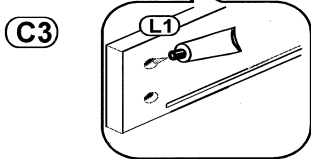
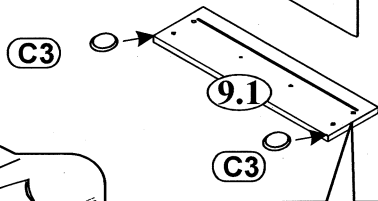
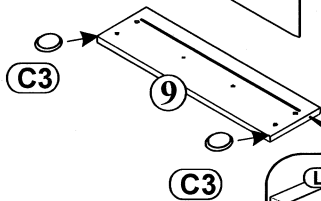

**3**

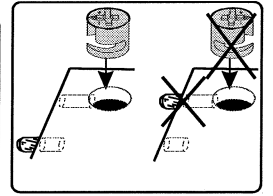
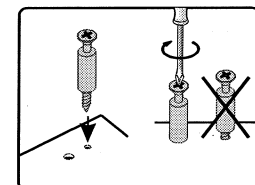
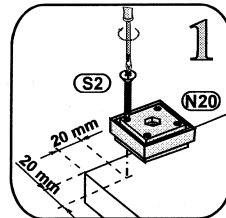
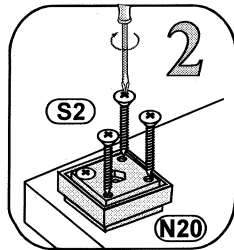
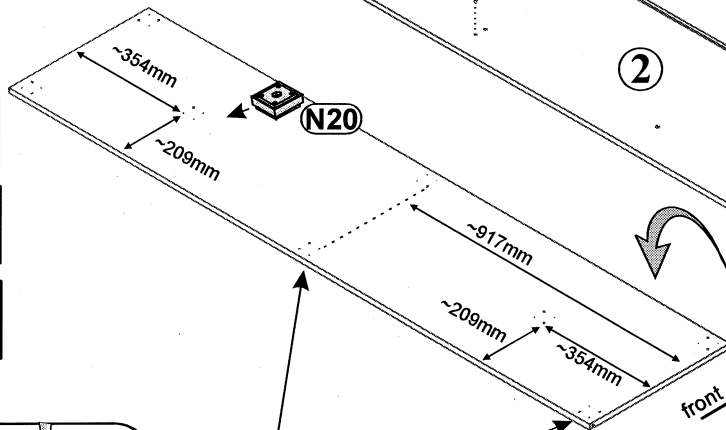
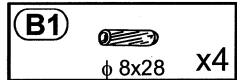
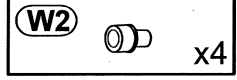
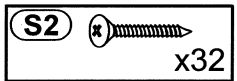
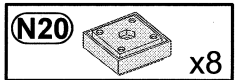
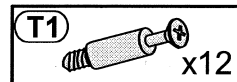
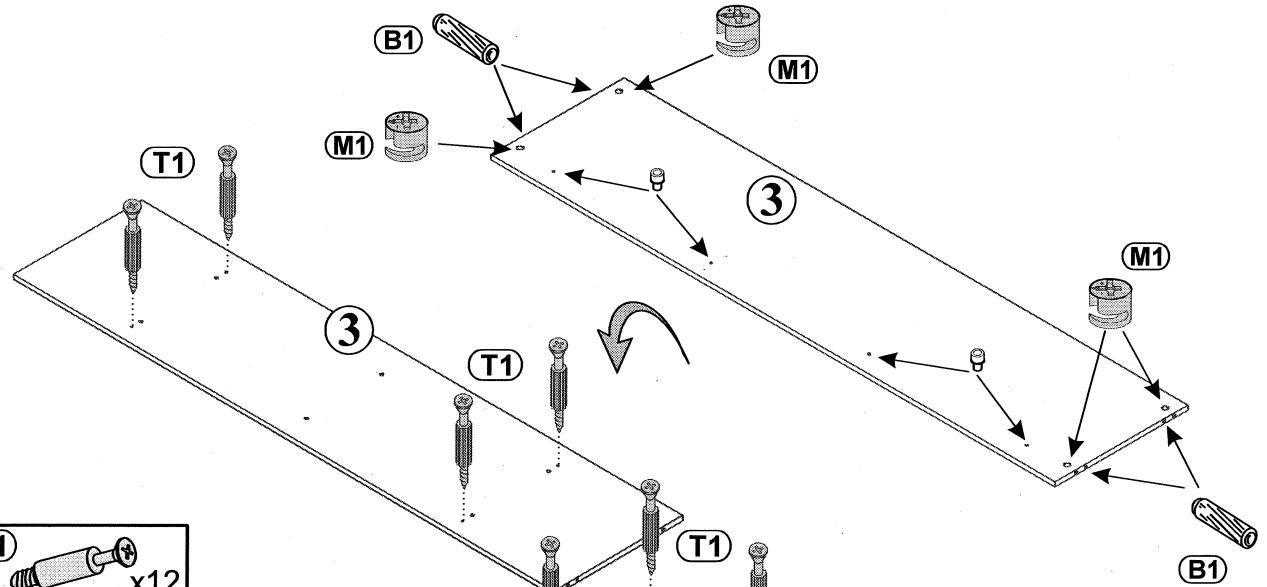

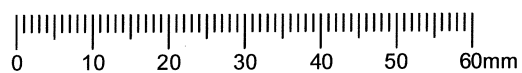
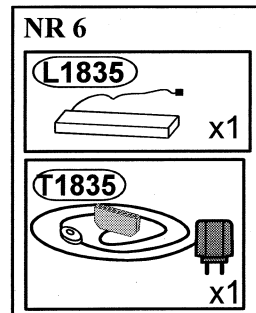
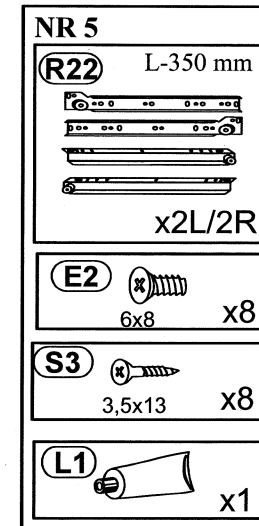
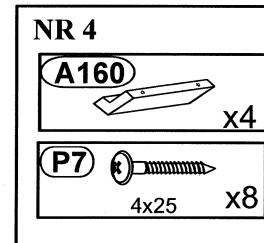
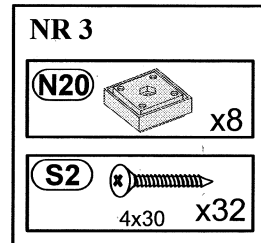
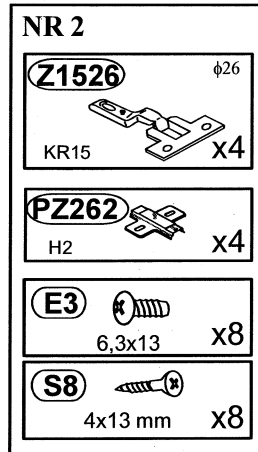
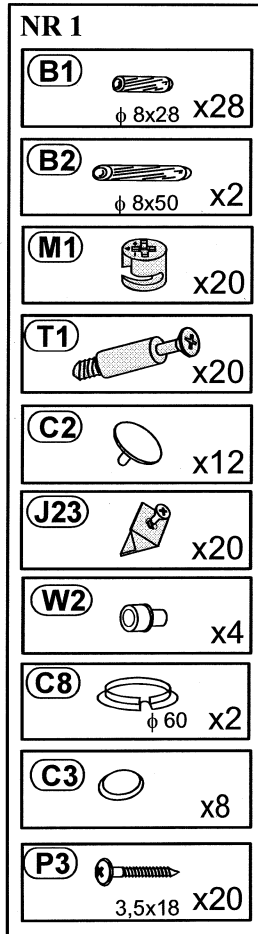

Modellname: **BLUE LINE**  
 Nazwa modelu:

Modellreihe: **45-294-...-8**  
 Numer modelu:

Type:  
 Typ:

Blatt Nr 3 von: 6  
 Strona z:

**1**

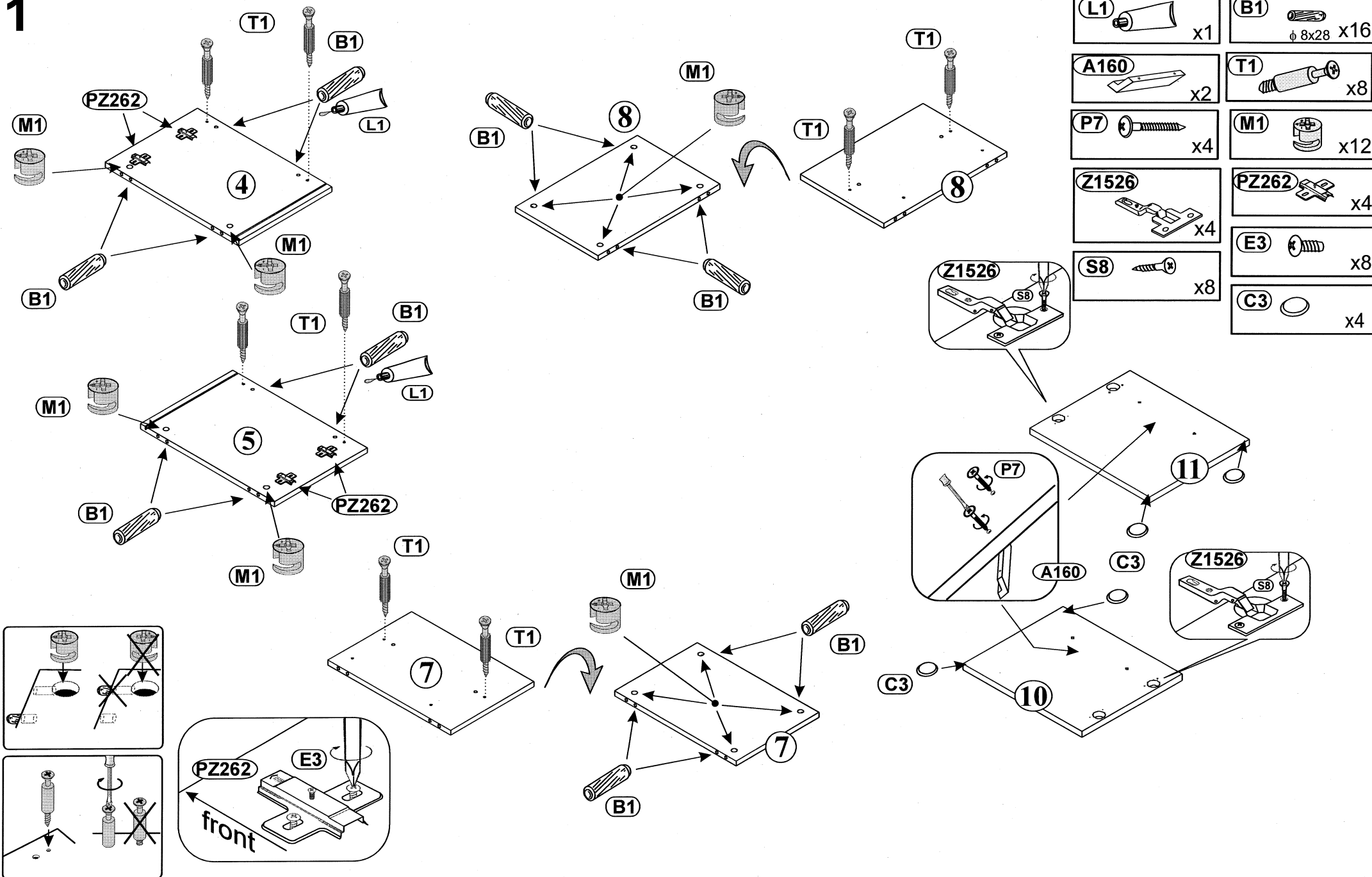

**4**

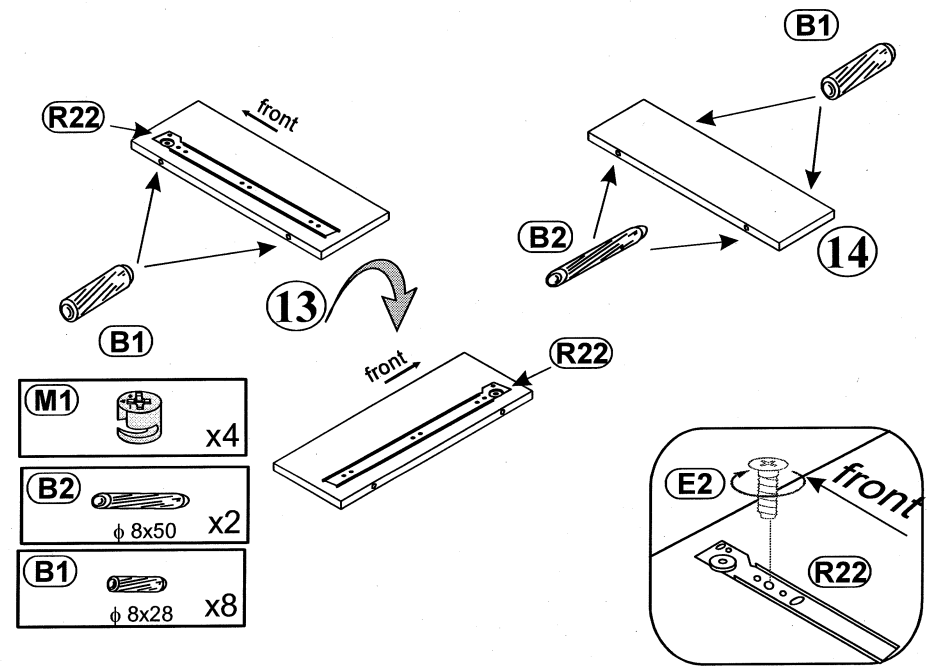
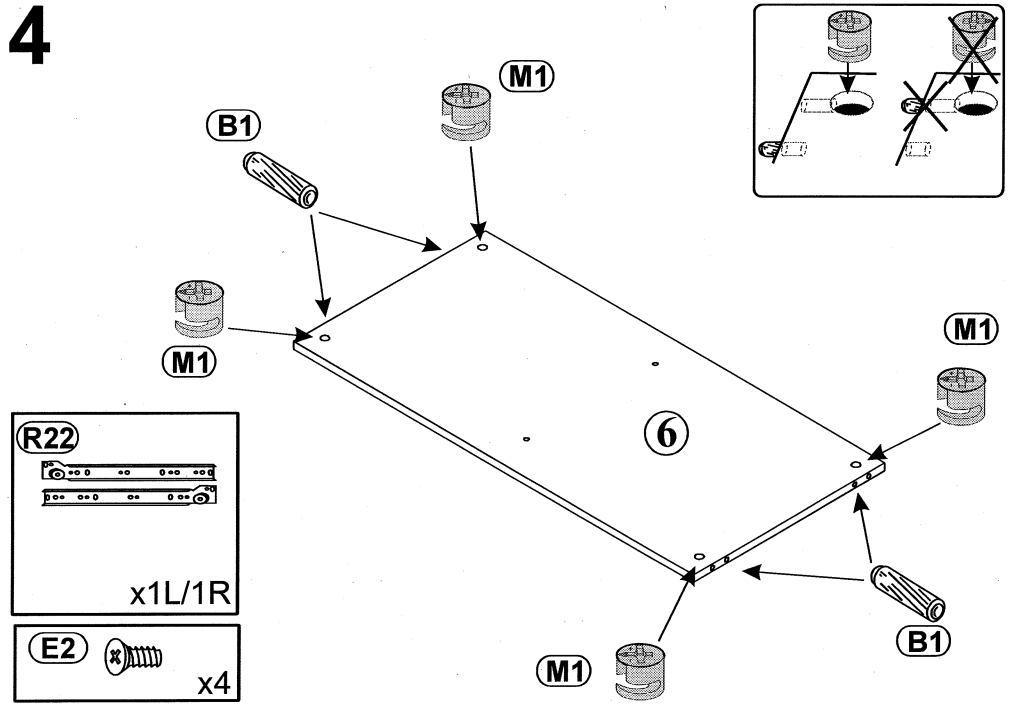

**5**

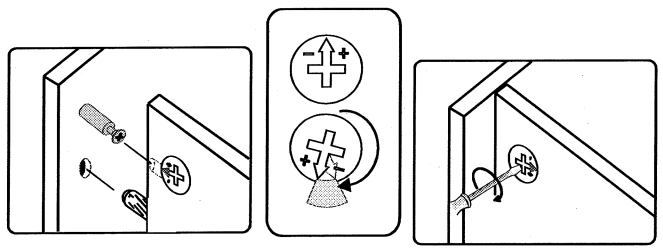
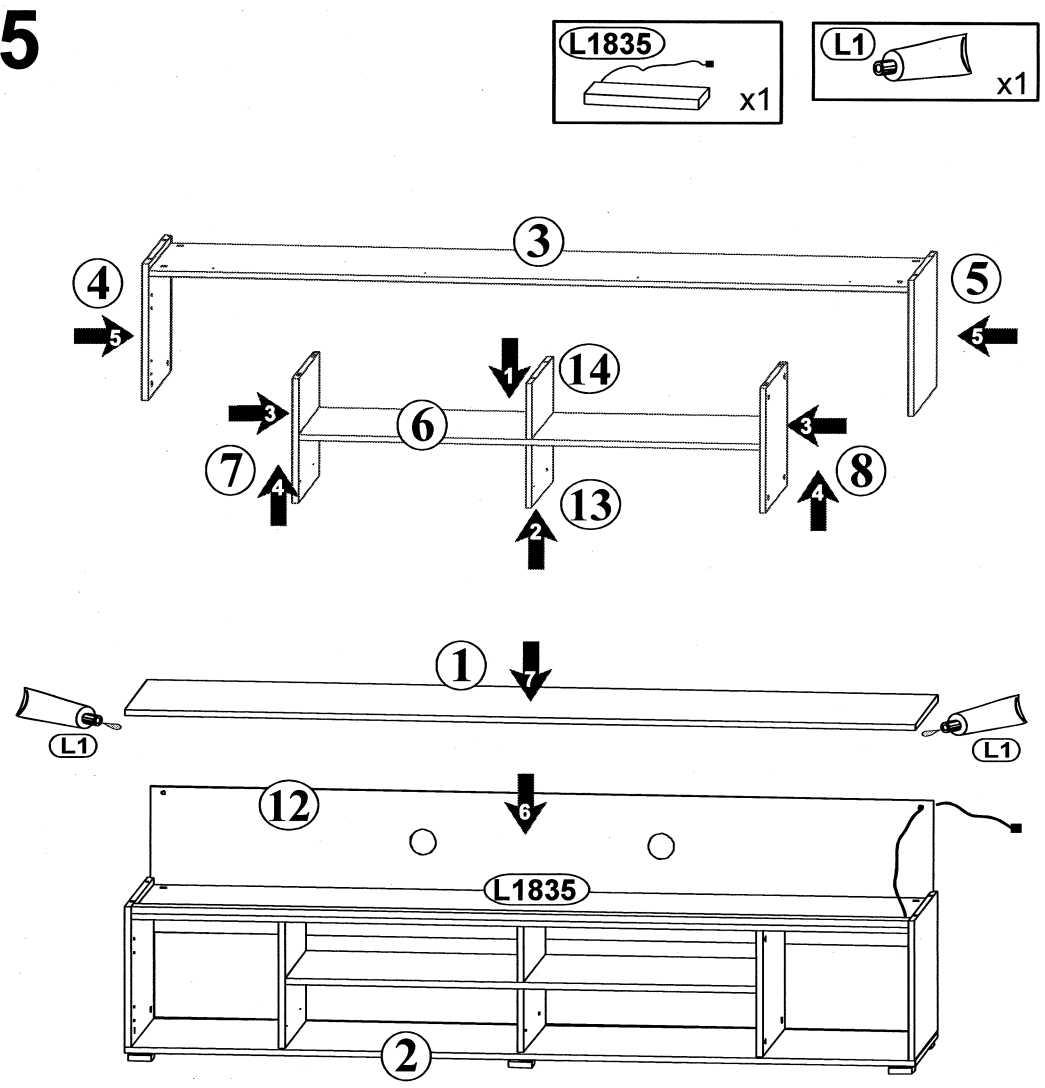

**6**

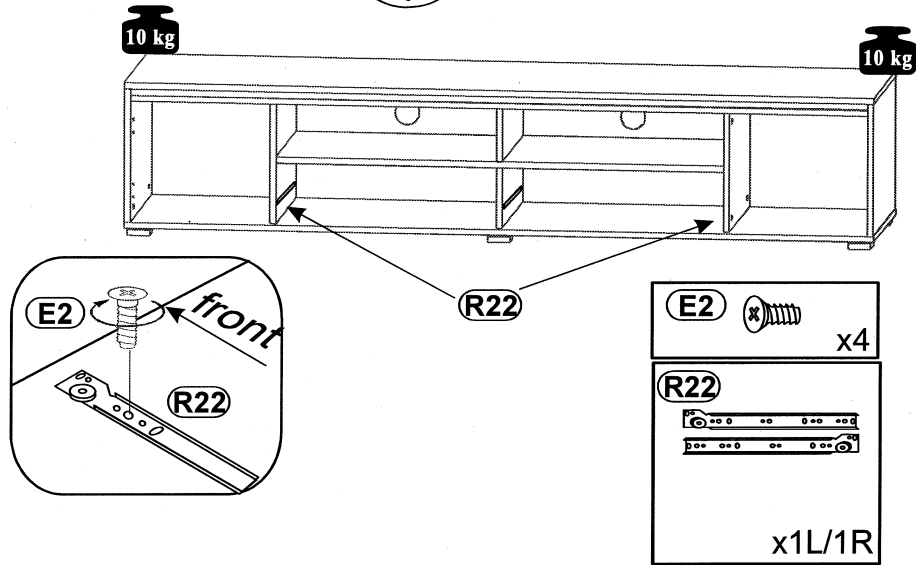

**7**

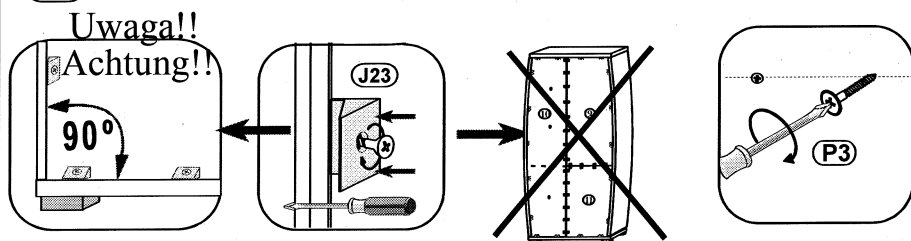
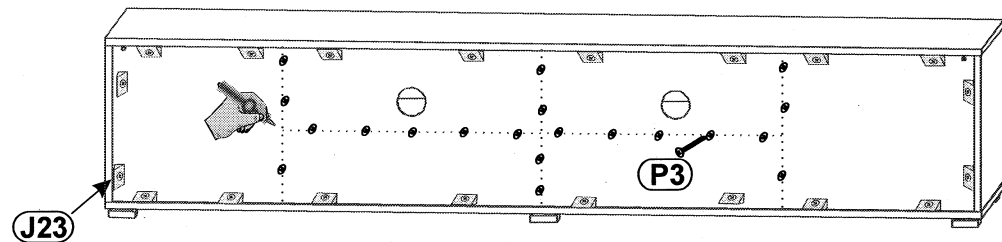
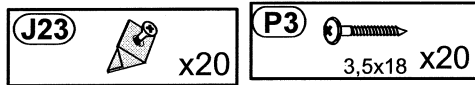

**8**

