

# Montageanleitung für das X-Beingestell

Versionsnummer:  
Version number:  
Numer wersji:

08.2020

Naturholz kann sich werkstoffbedingt verziehen. Durch das Montieren ziehen sich Teile wieder plan.

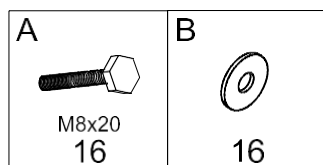
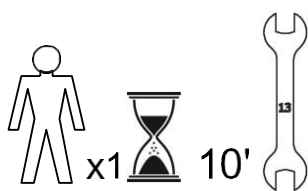
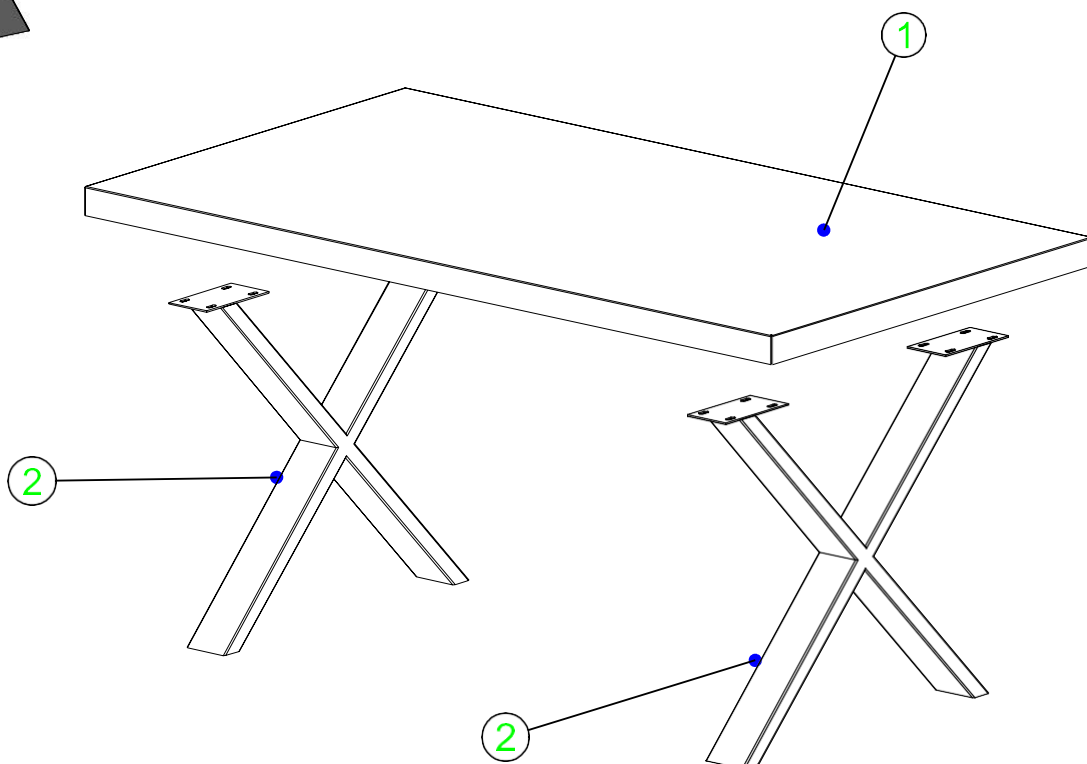
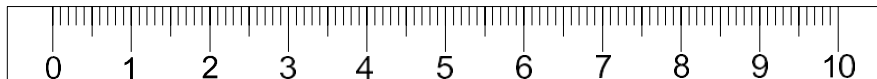

Wood is a natural material and can be distorted. However, when the furniture is assembled, the parts straighten out.

Drewno jest surowcem naturalnym i może ulec wypaczeniu. Jednakże, po zmontowaniu mebla w całość części wyprostowują się.

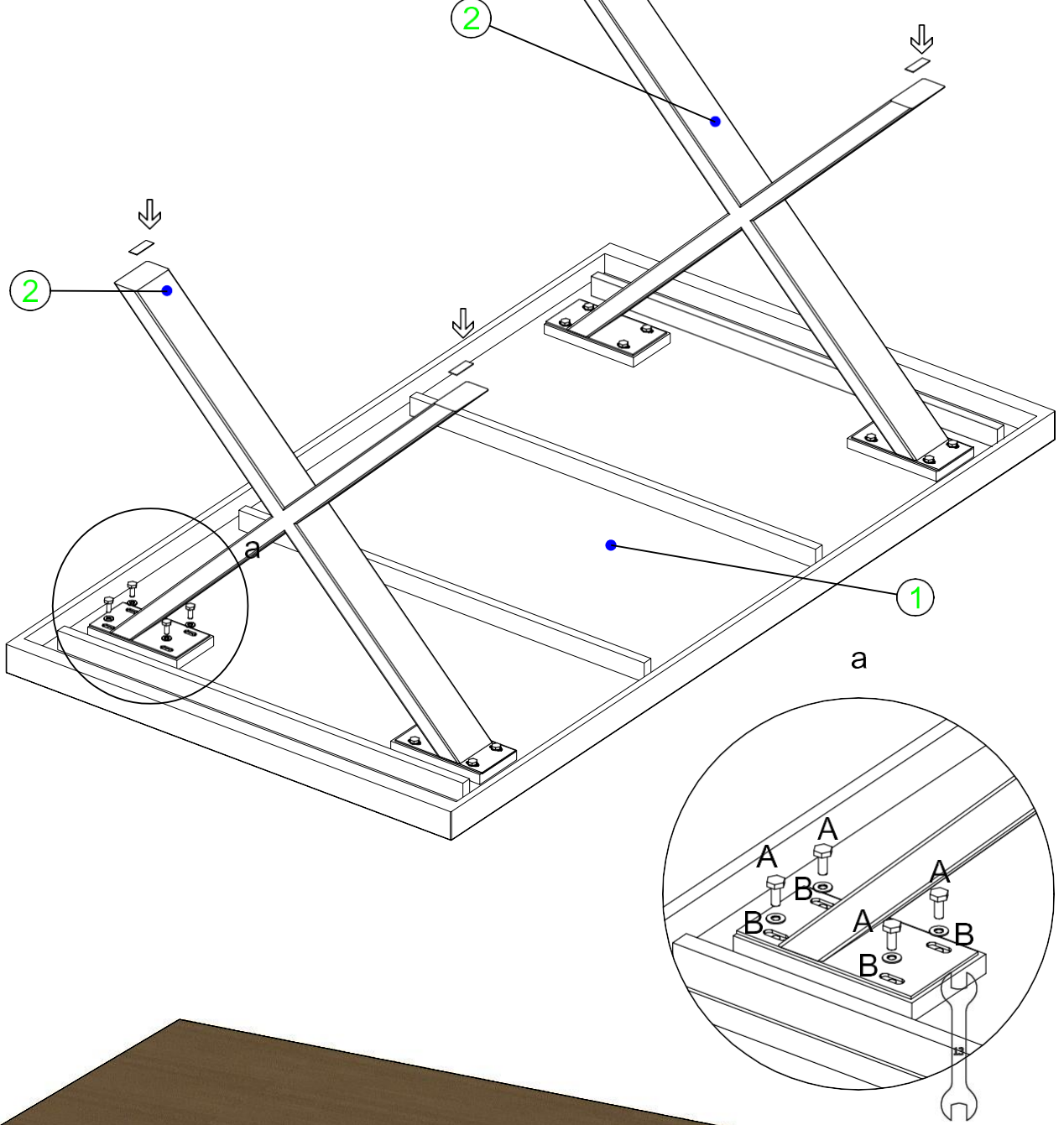



I

<p>A</p>  <p>M8x20 16</p>	<p>B</p>  <p>16</p>
--	--