

GENEVA

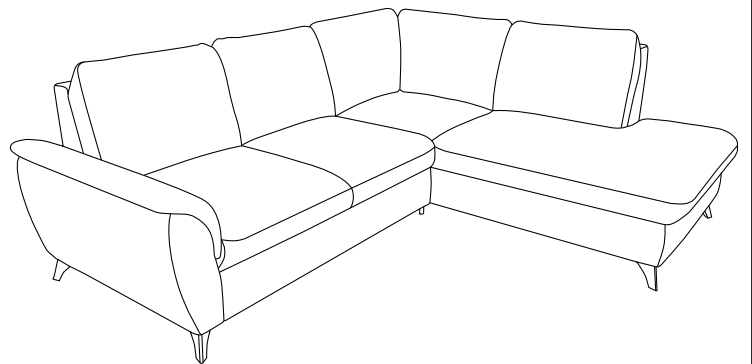

30min

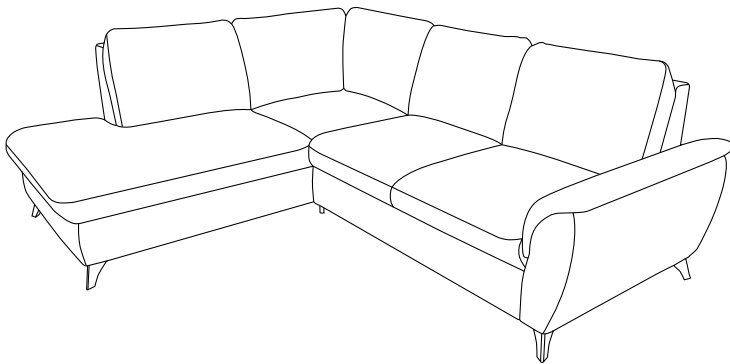
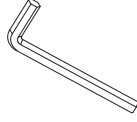
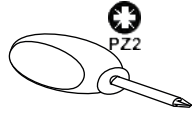
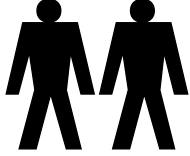

I

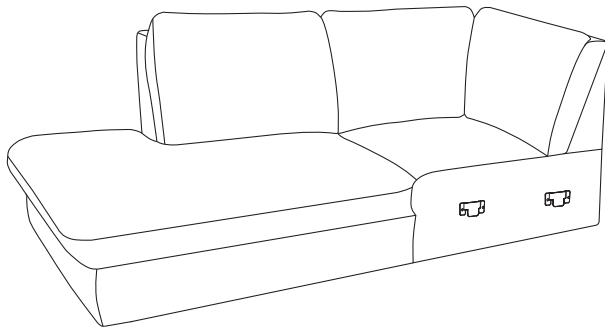

II

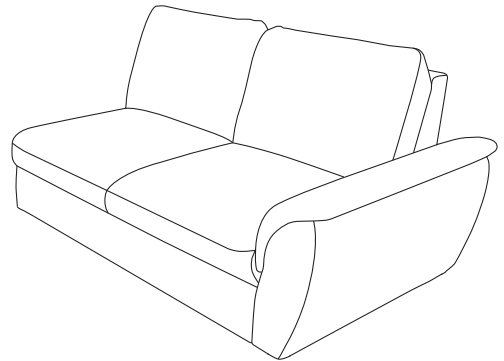

Ax4



H= 105 mm

Bx2



H= 100 mm

Cx1

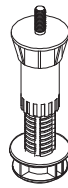

H=90-140 mm

Dx12

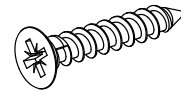

5x25



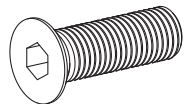

Ex4





8x25

1

Ax2 
H= 105 mm

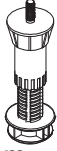
Bx2 
H= 100 mm

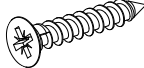
Cx1 
H=90-140 mm

Dx6 
5x25 

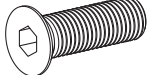
Ex2 
8x25

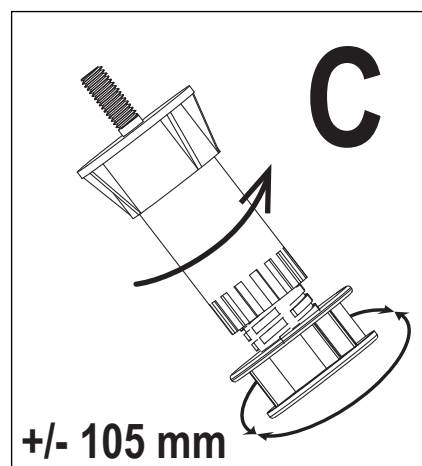
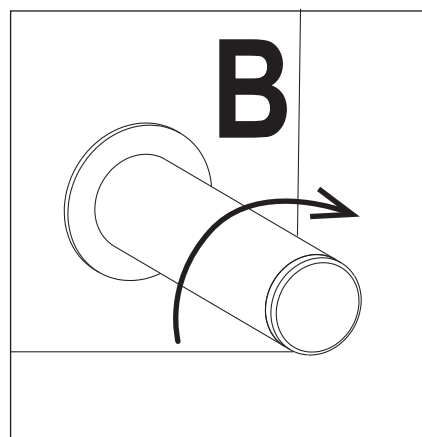
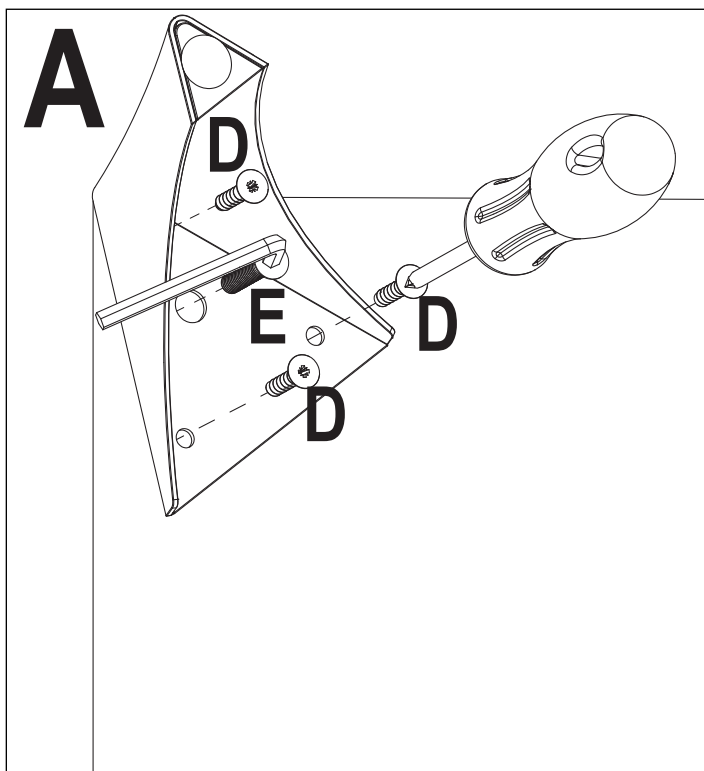
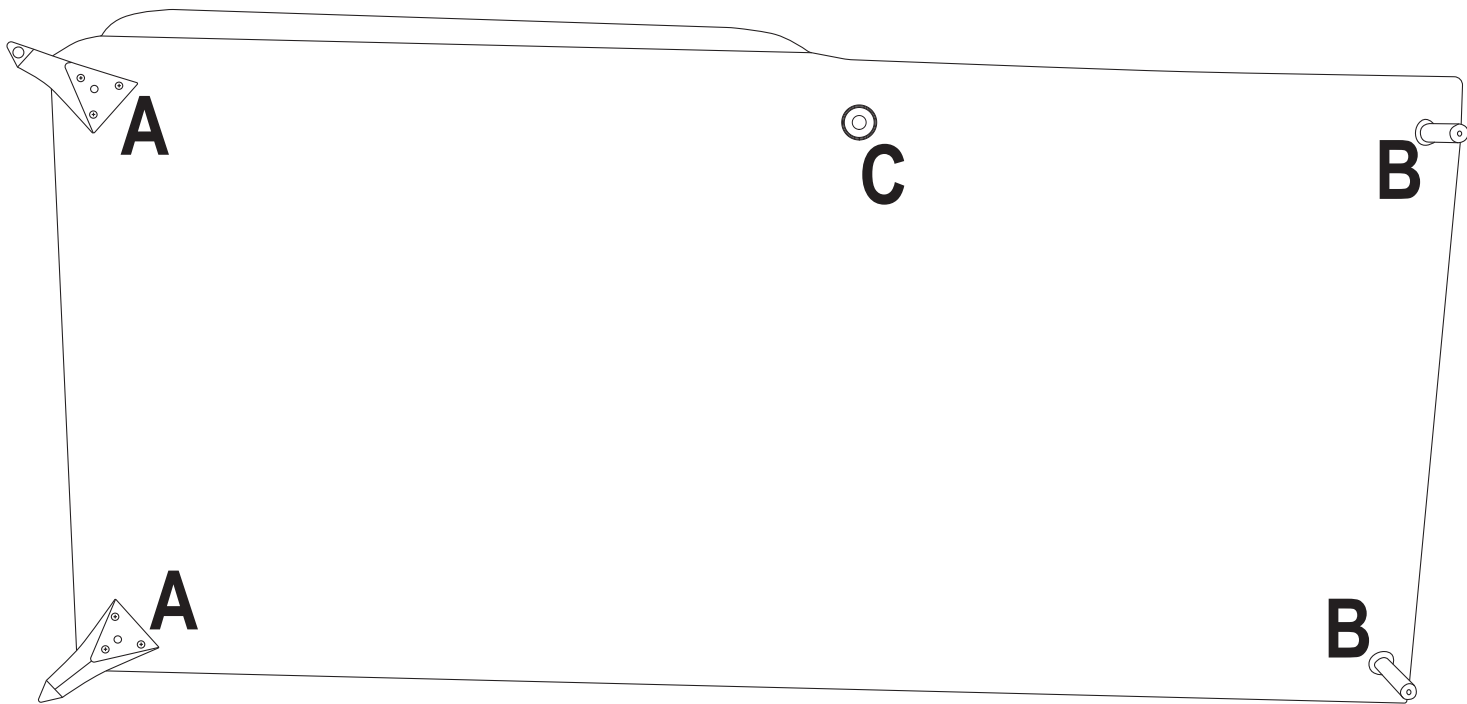

2

Ax2



H= 105 mm

Dx6

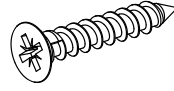

5x25



Ex2

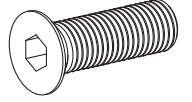

8x25

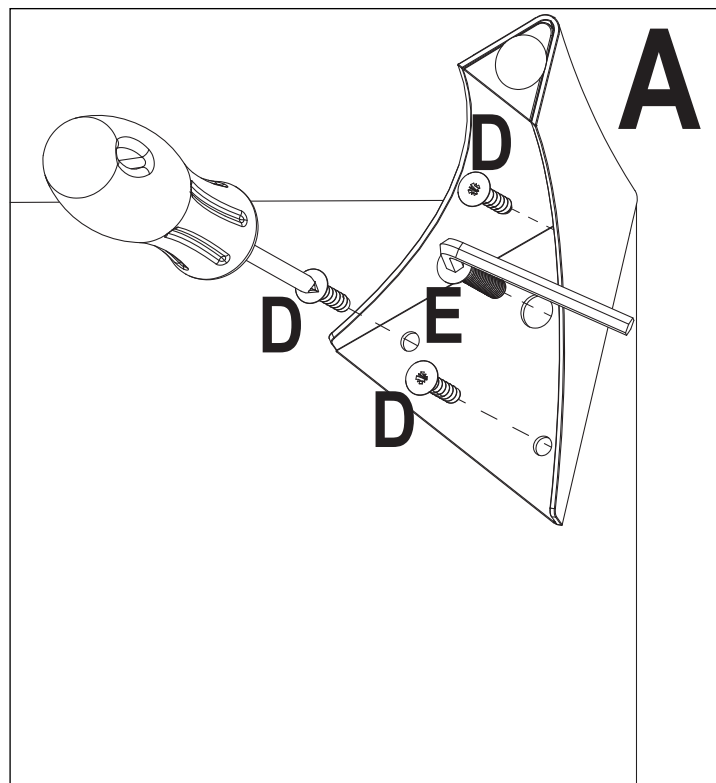
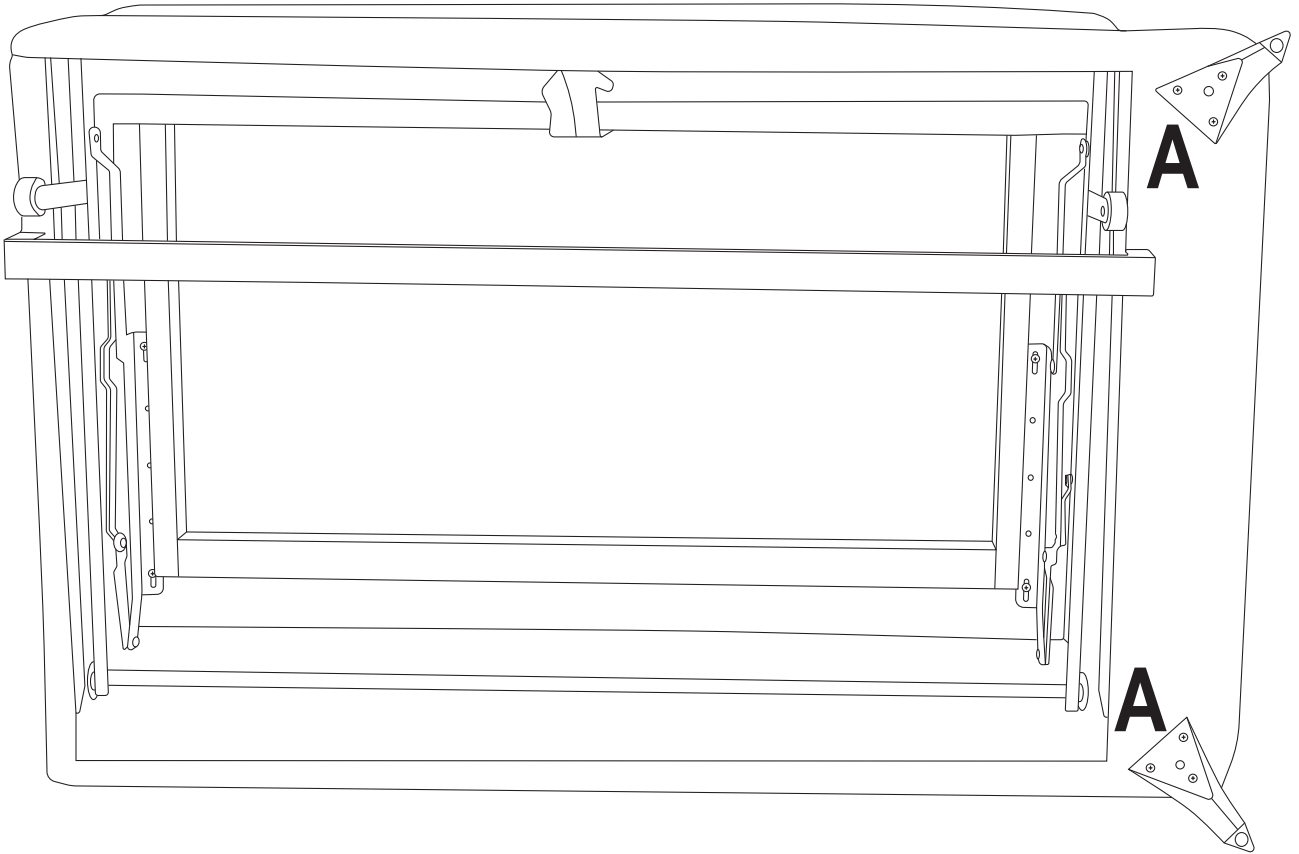

3

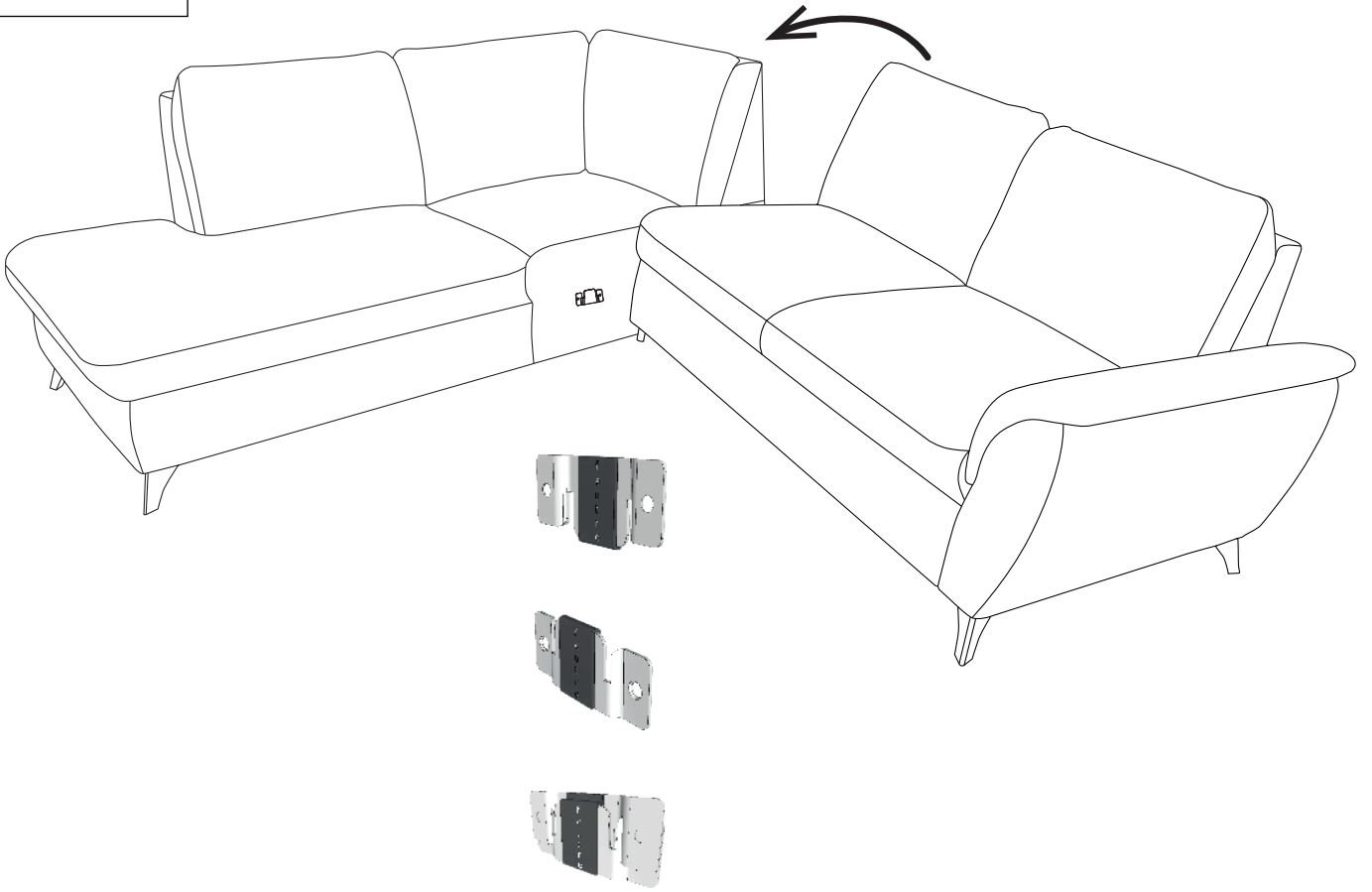

4

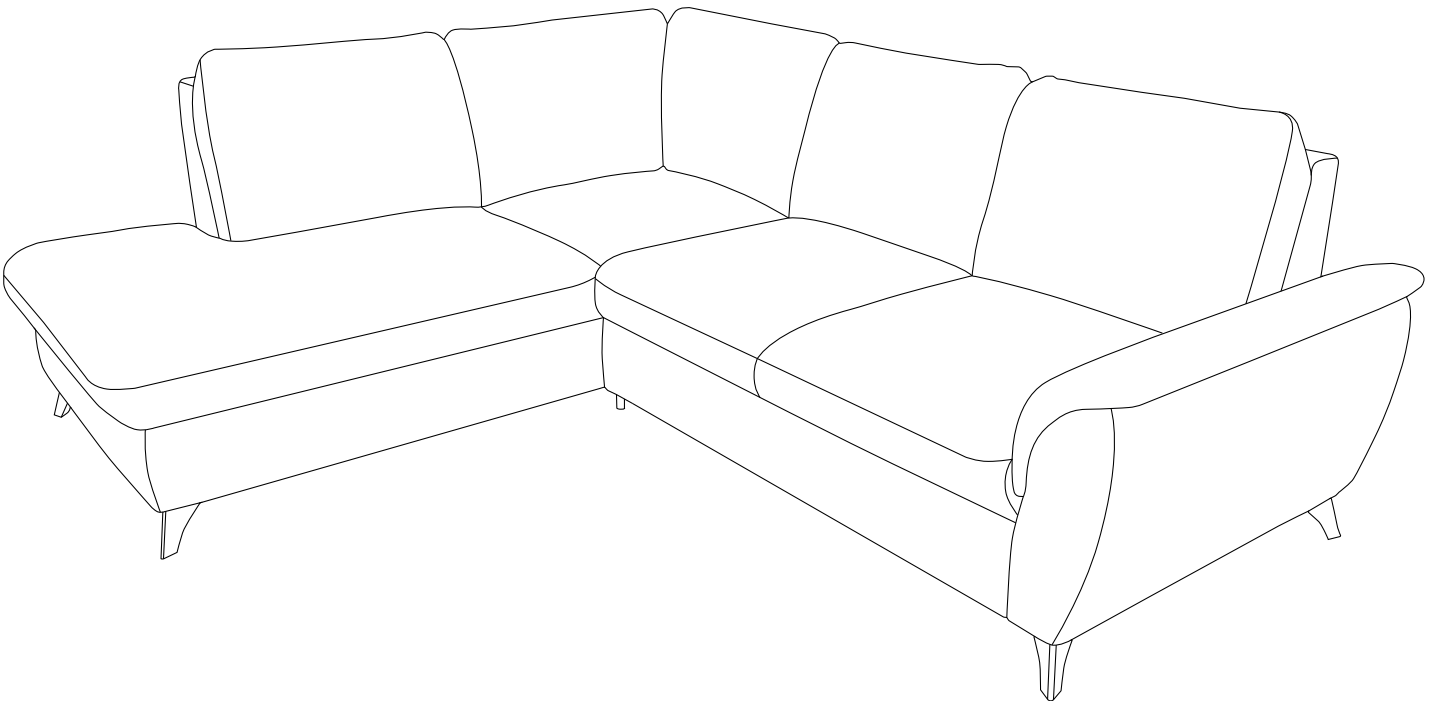

5

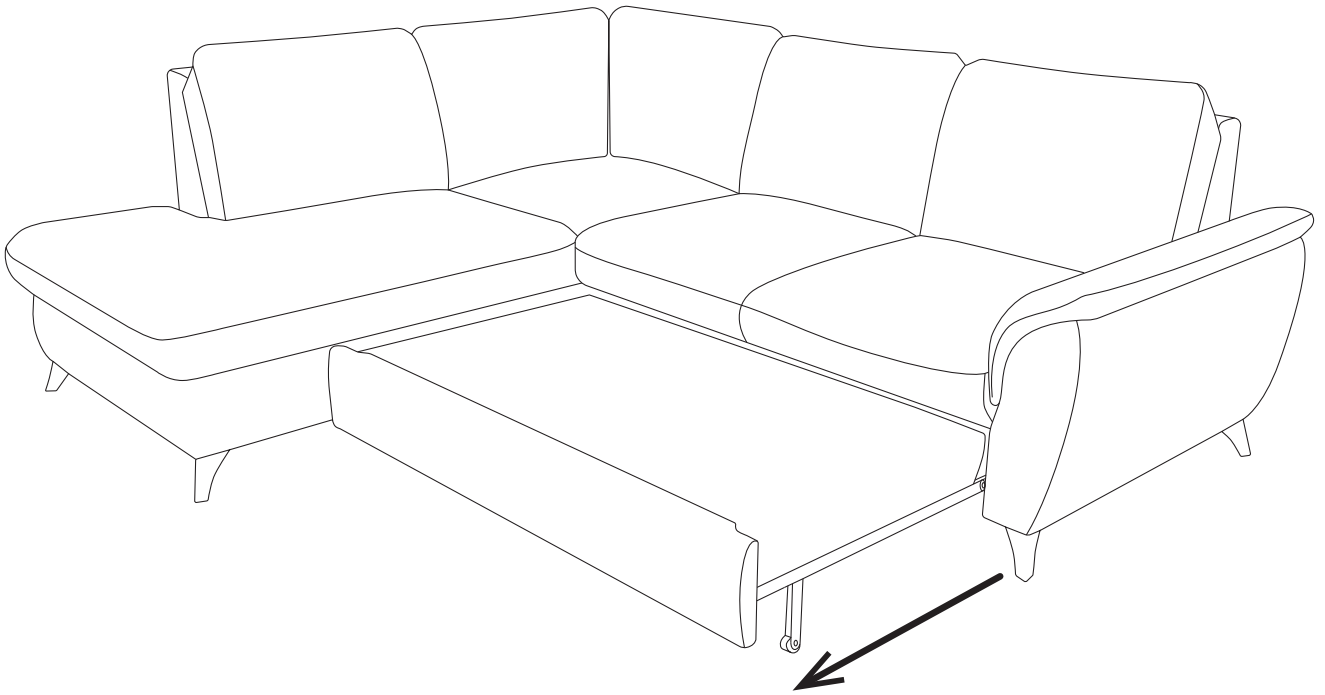

6

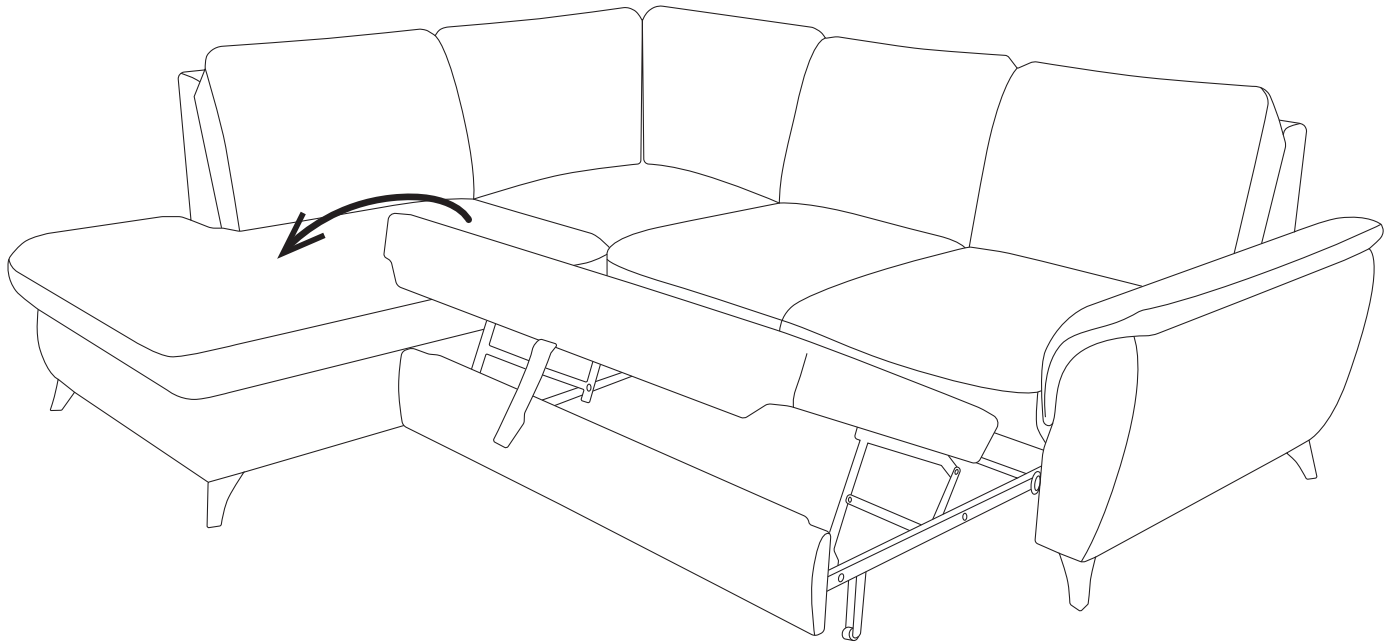

7

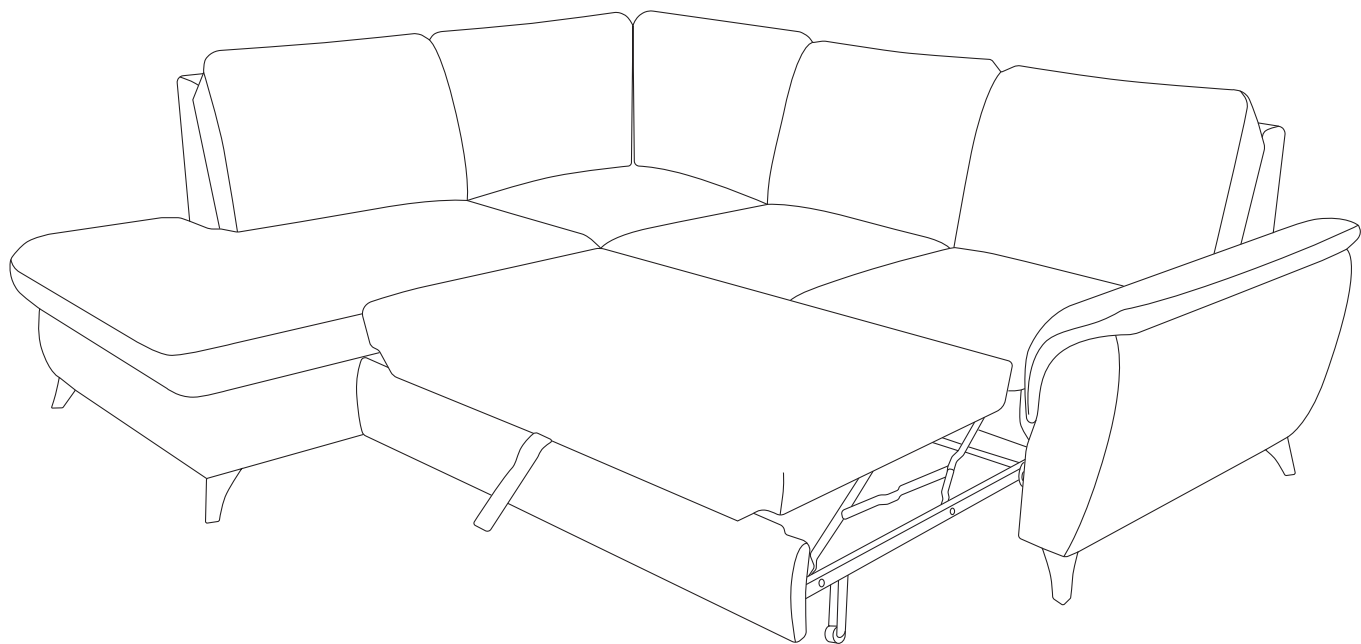

8

