



TRE VITRINE

46-020-...-3

1/12



wyprodukowano dla / made for / produziert für
BEGA GRUPPE
producent: **MEBLE OKMED** POLAND

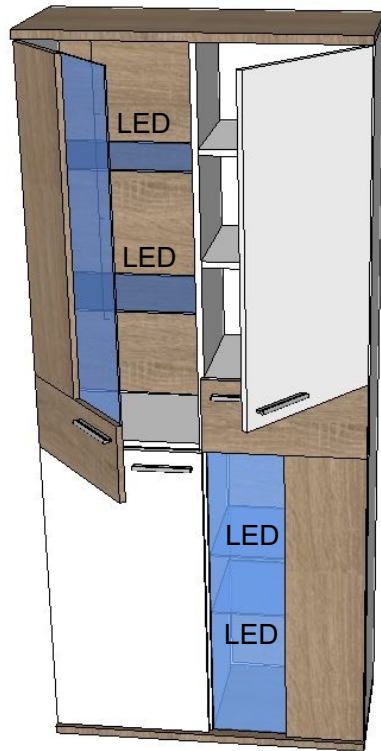
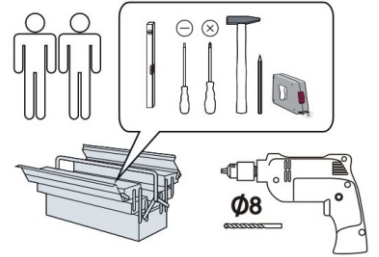

<http://www.bega-gruppe.de>



BG	Bulgarsisch	Български
CS	Tschechisch	Čeština
DA	Dänisch	Dansk
DE	Deutsch	Deutsch
ET	Estonisch	Eesti
EL	Griechisch	ελληνικά
EN	Englisch	English
ES	Spanisch	español
FR	Französisch	Français
FI	Finnisch	suomalainen
HR	Kroatisch	hrvatski
HU	Ungarisch	magyar
IT	Italienisch	italiano
LV	Lettisch	Latvijas
LT	Litauisch	Lietuvos
NL	Niederländisch	Nederlands
PL	Polnisch	Polski
PT	Portugiesisch	português
RO	Rumänisch	român
SK	Slowakisch	slovenský
SL	Slowenisch	slovensčina
SV	Schwedisch	Svenska

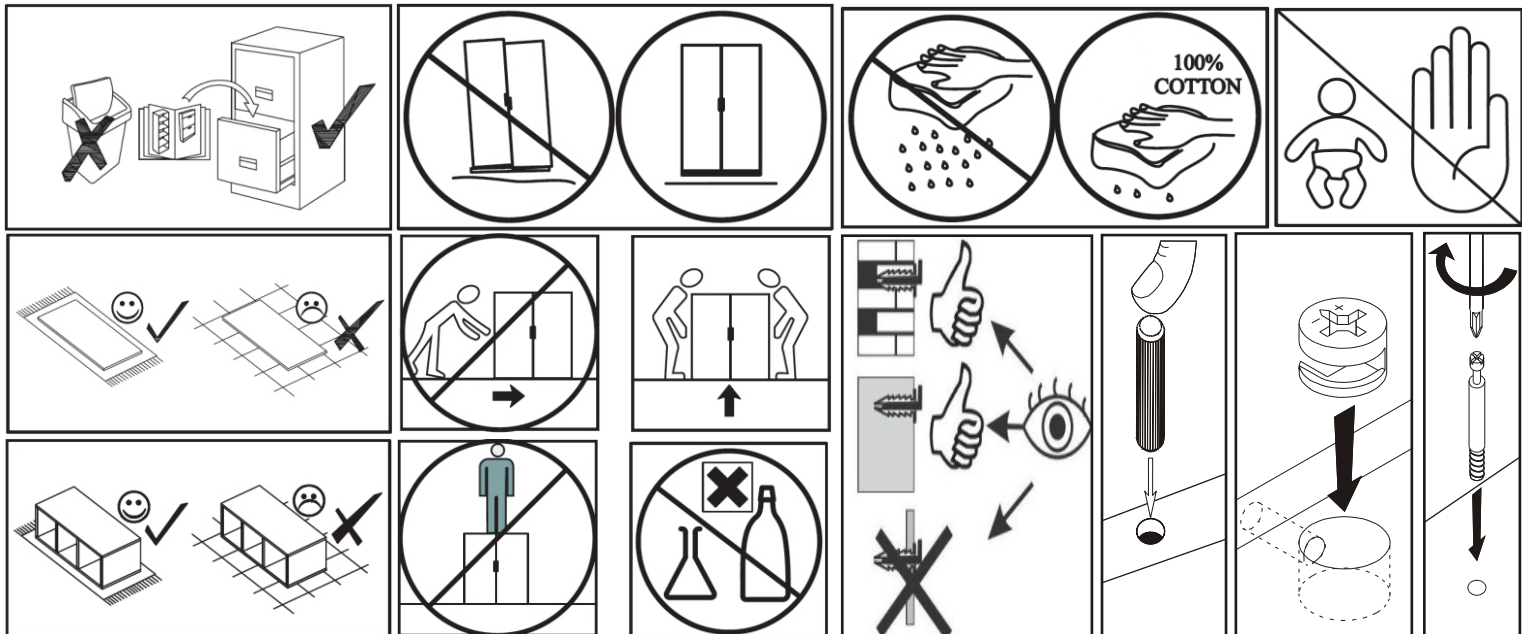
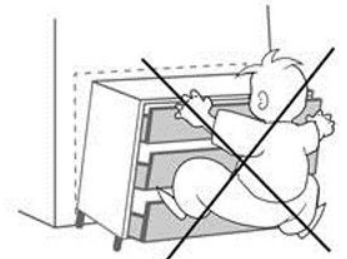
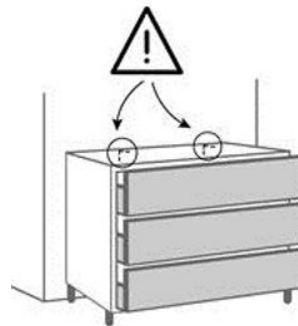

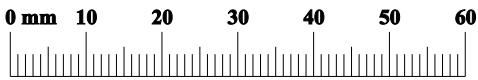
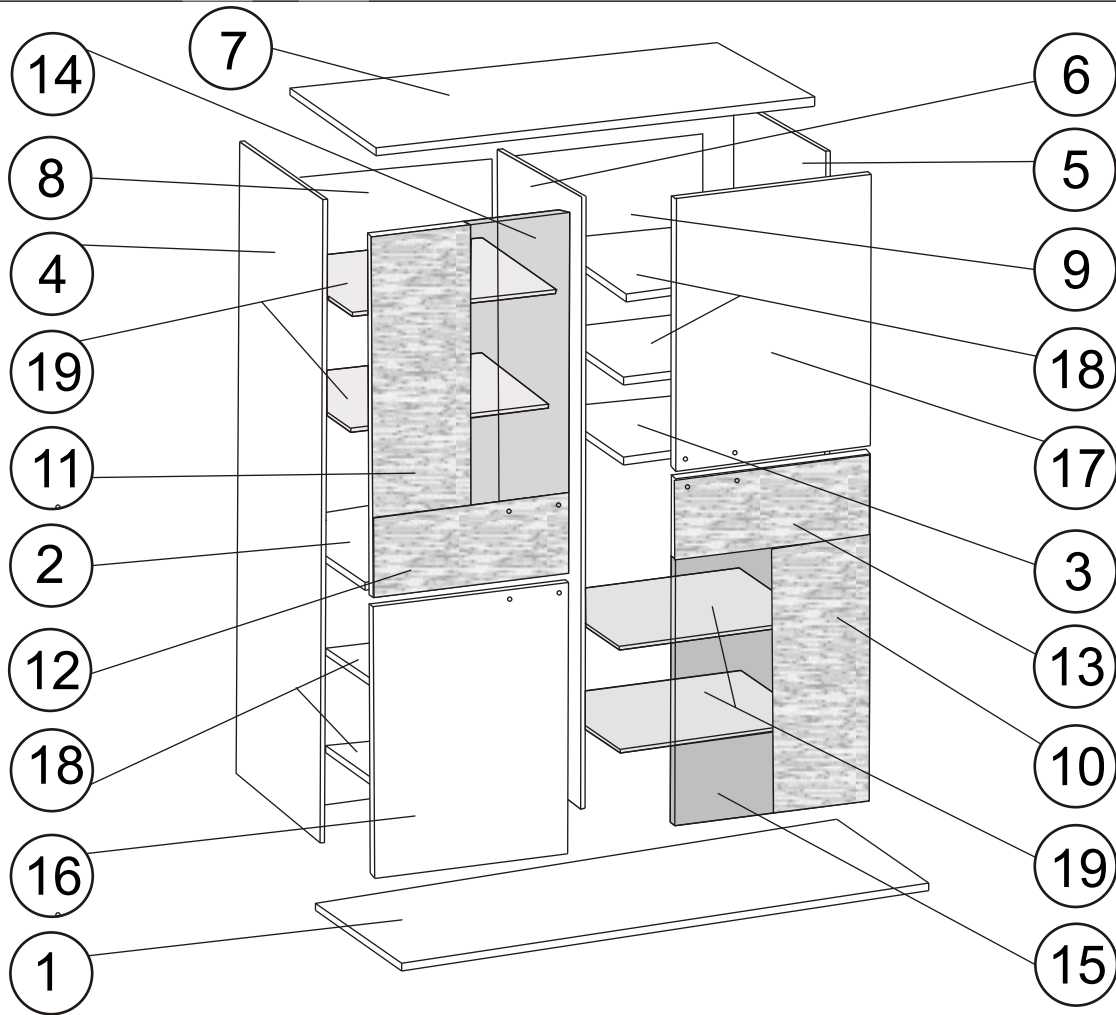







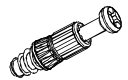





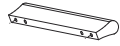

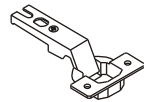
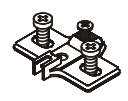



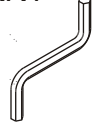

1/3	1	22x363x840	x1
	7	22x363x840	x1
	18	16x317x395	x4
	2,3	16x327x395	x2
	10,11	16x208x826	x2
	12	16x195x416	x1
	13	16x195x416	x1

2/3	19	5x395x302	x4
	14,15	4x229x856	x2
	4	16x345x1853	x1
	5	16x345x1853	x1

3/3	16	16x416x823	x1
	17	16x416x823	x1
	6	16x327x1853	x1
	8,9	3x412x1869	x2

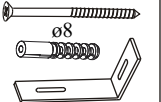
K1  ø7x50 x12	ZM1B  x8	ZM1A  x12	ZM1  ø16 x4	ZM1  ø16 x8
KD2  ø8x60 x4	TS1  x10	U75  x4	U75A  ø3,5x27 x8	ZKL2  x4 x1
Z1  x10	Z1P  x10	KD1  ø8x35 x20	S1  x12	PP  x32
KK1  x1	W1  ø3x16 x16	W11  ø3,5x16 x2	W4  ø4x13 x20	W6  ø4x20 x5
W12  ø4x16 x10	SS3  x5	TPP2  L-70 x2	PL1  x12	KRW1  ø8 x4 KS1 x1

TRE VITRINE

3/12

01

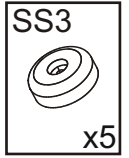
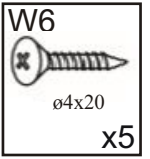
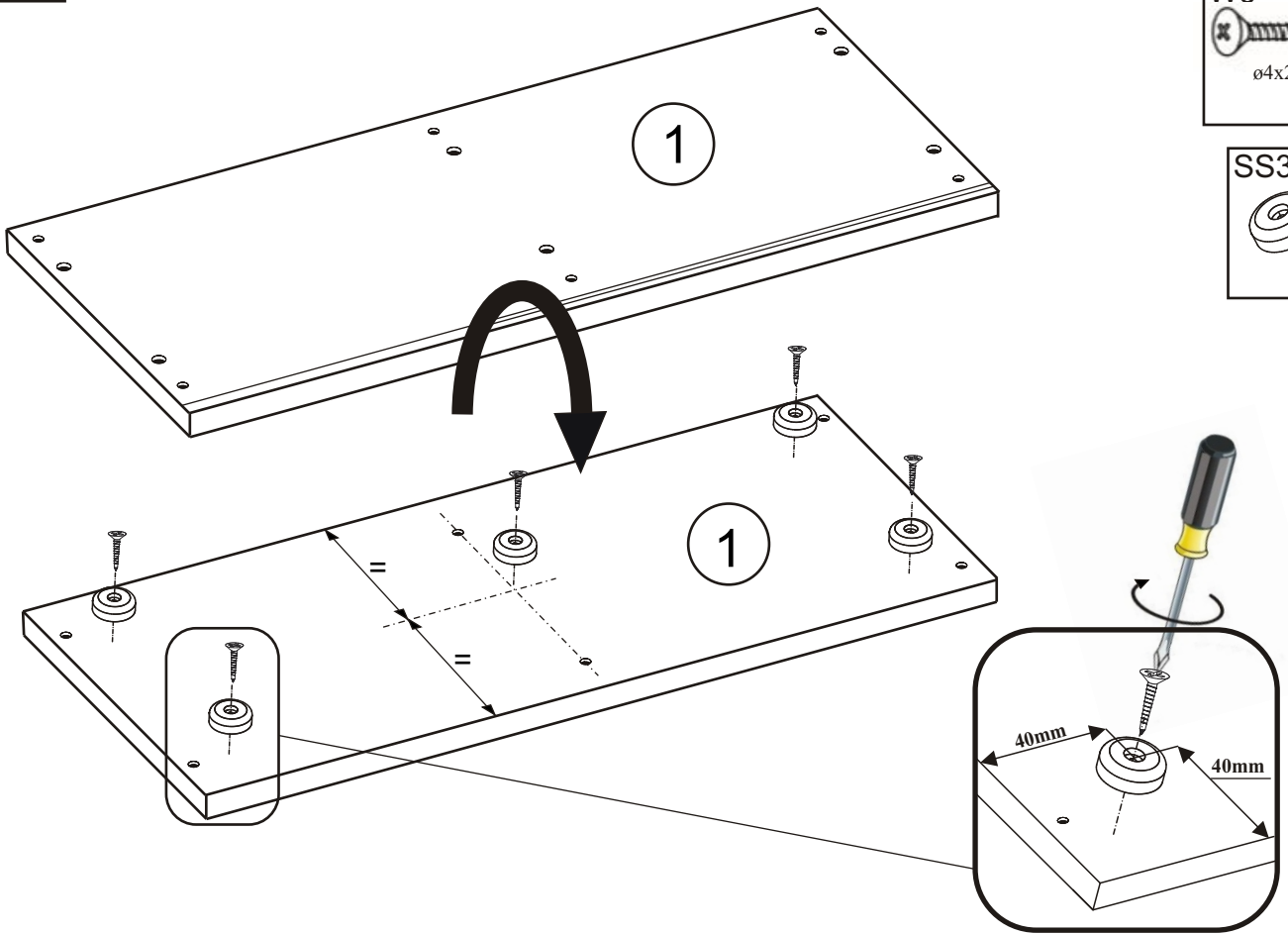

02

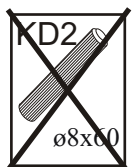
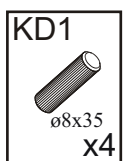
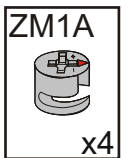
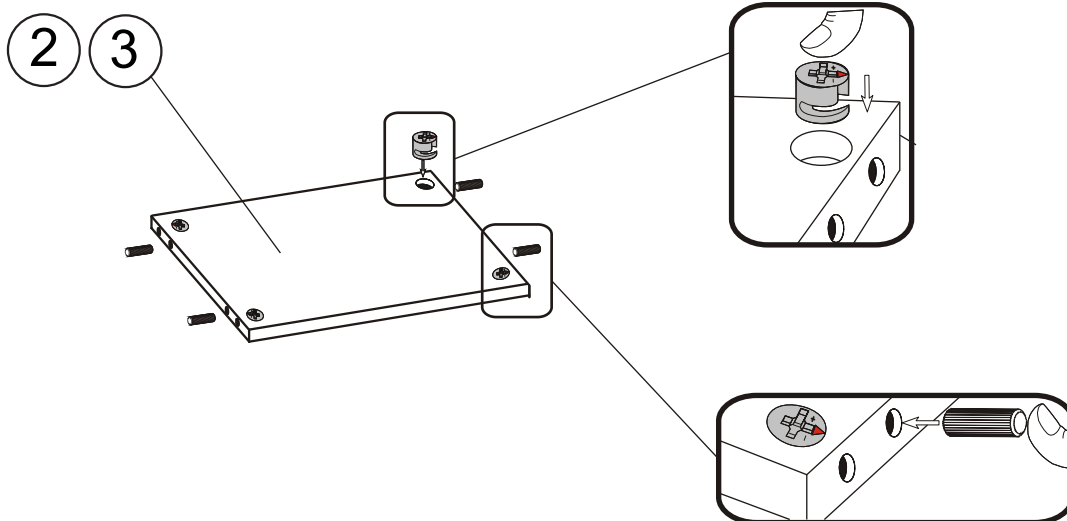

03

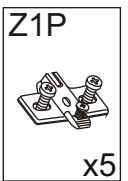
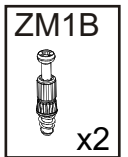
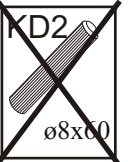
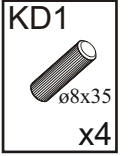
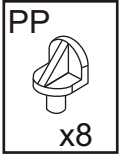
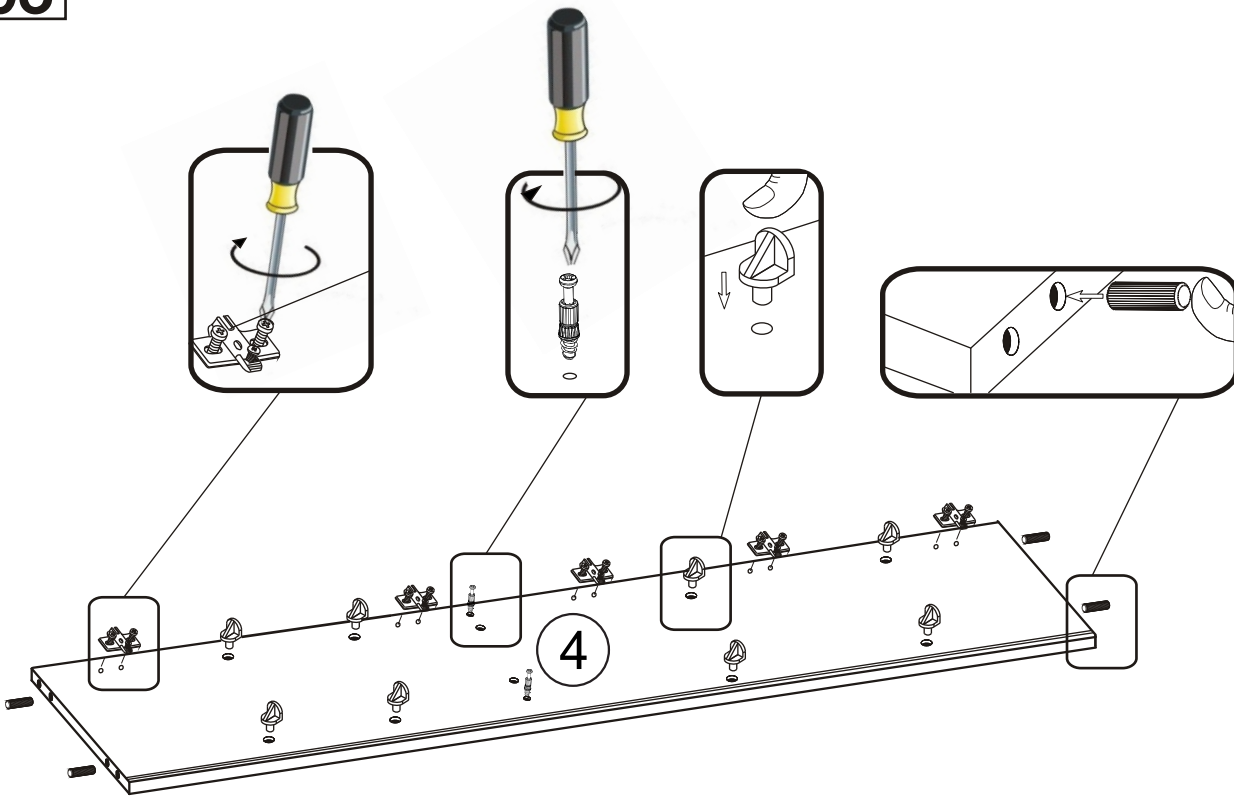

04

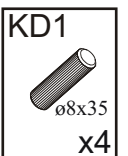
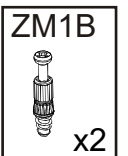
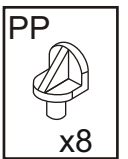
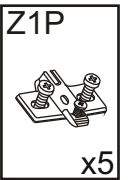
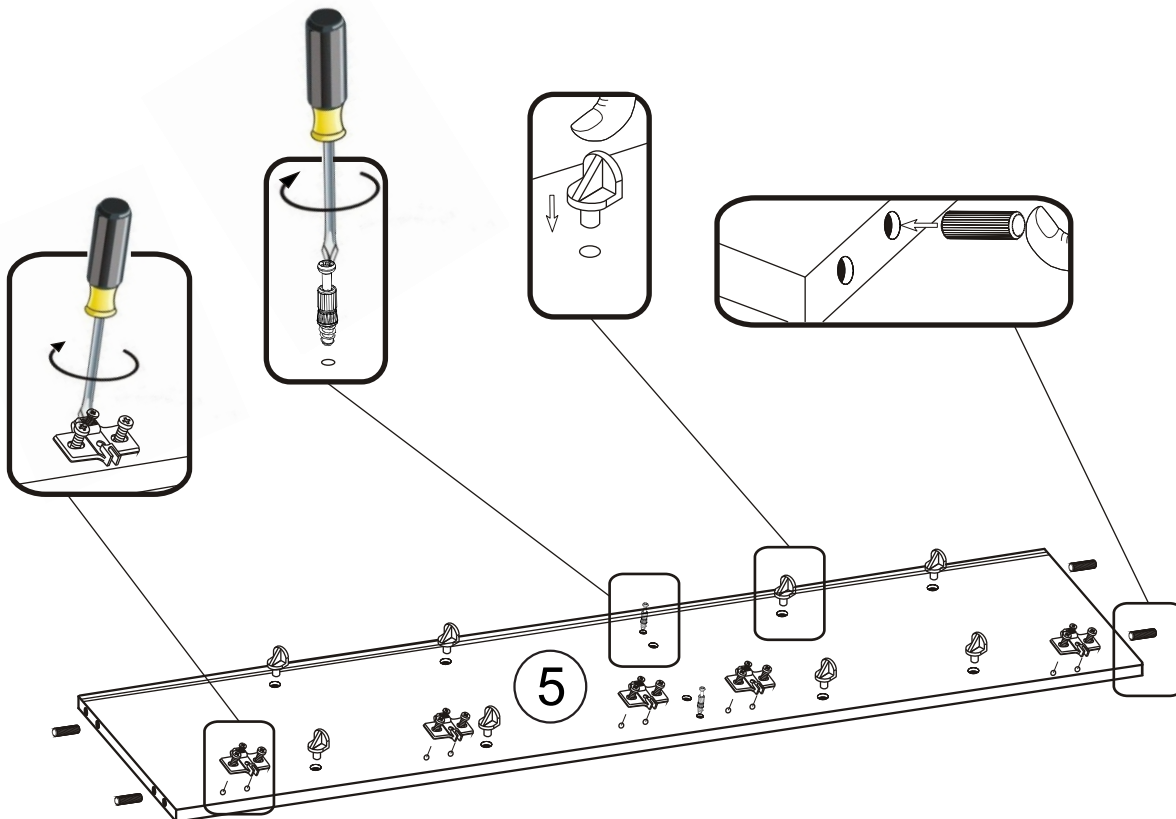

05

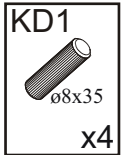
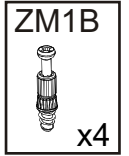
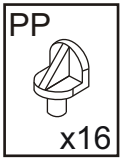
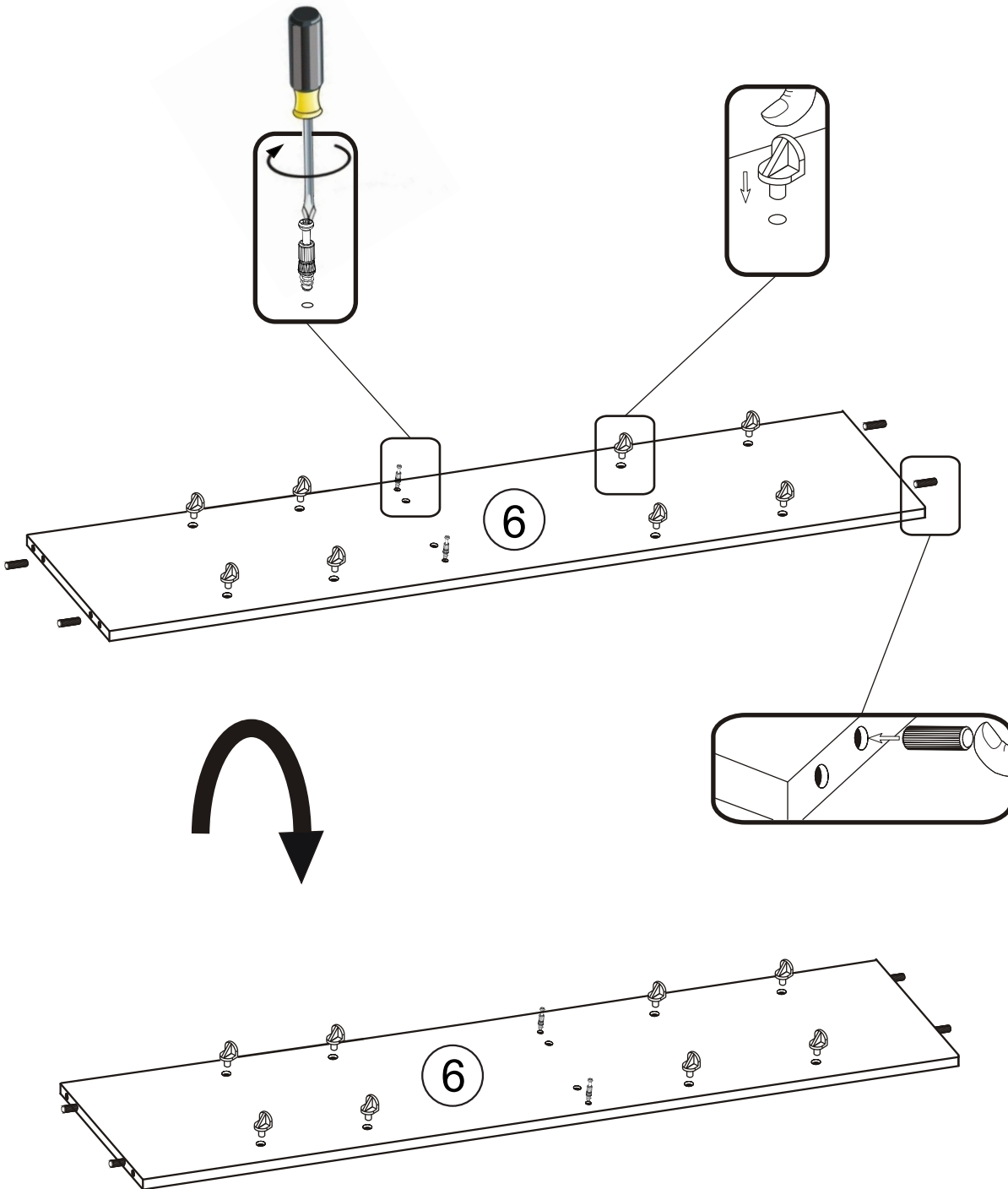

06

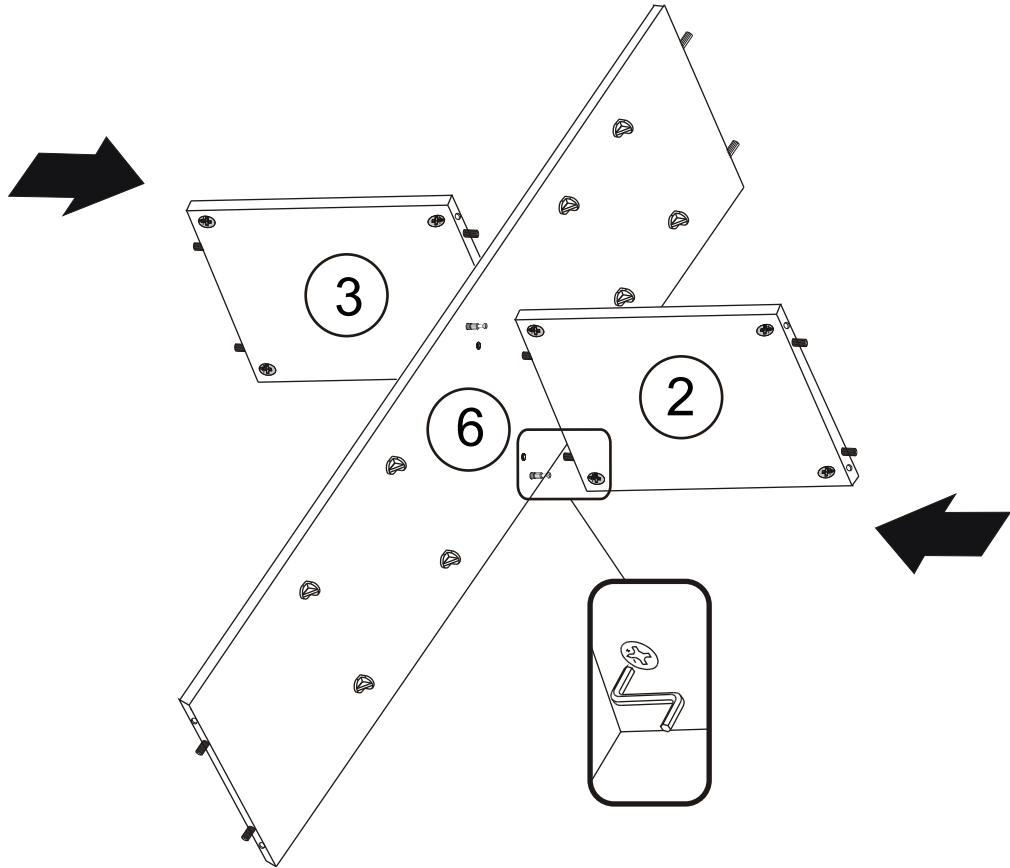

07

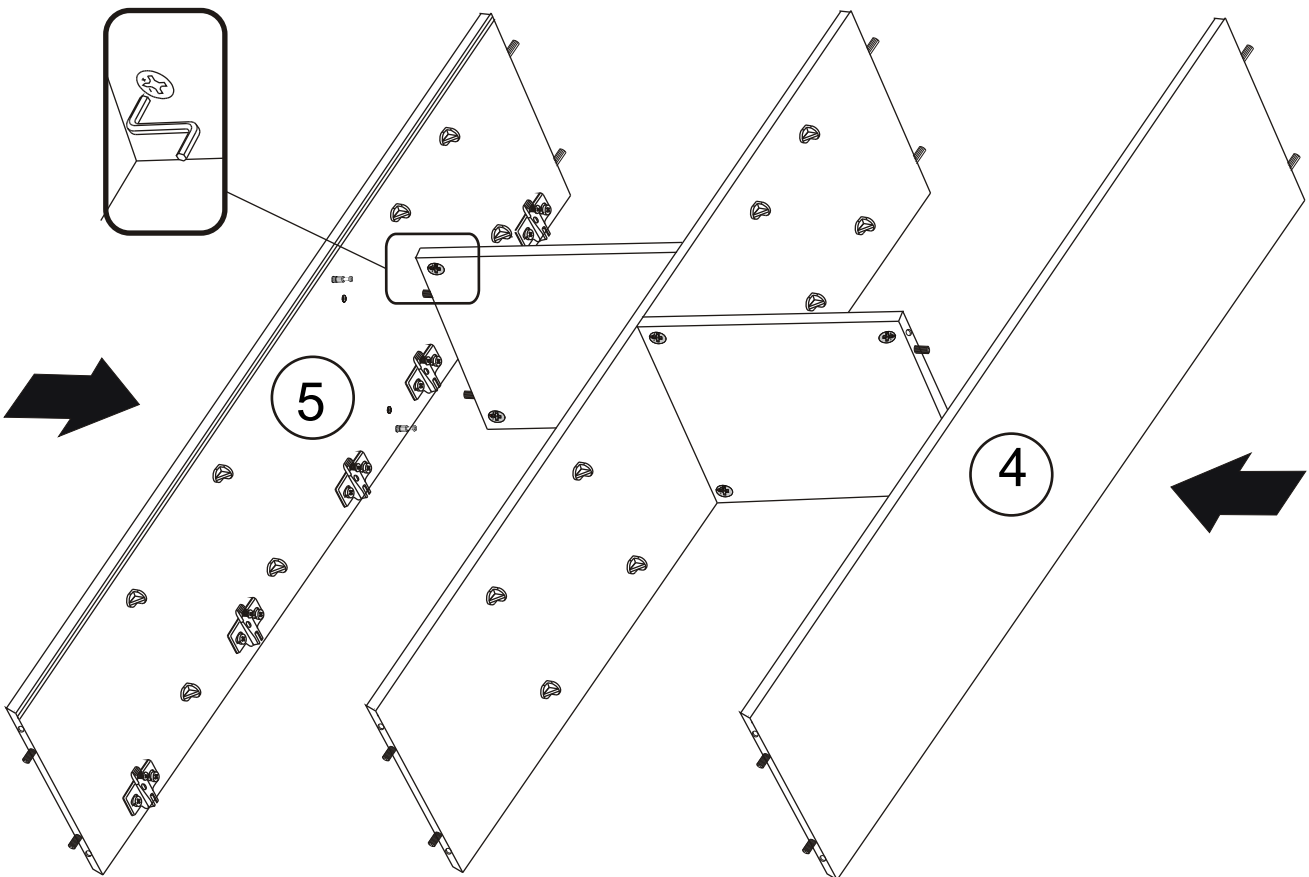

TRE VITRINE

7/12

08

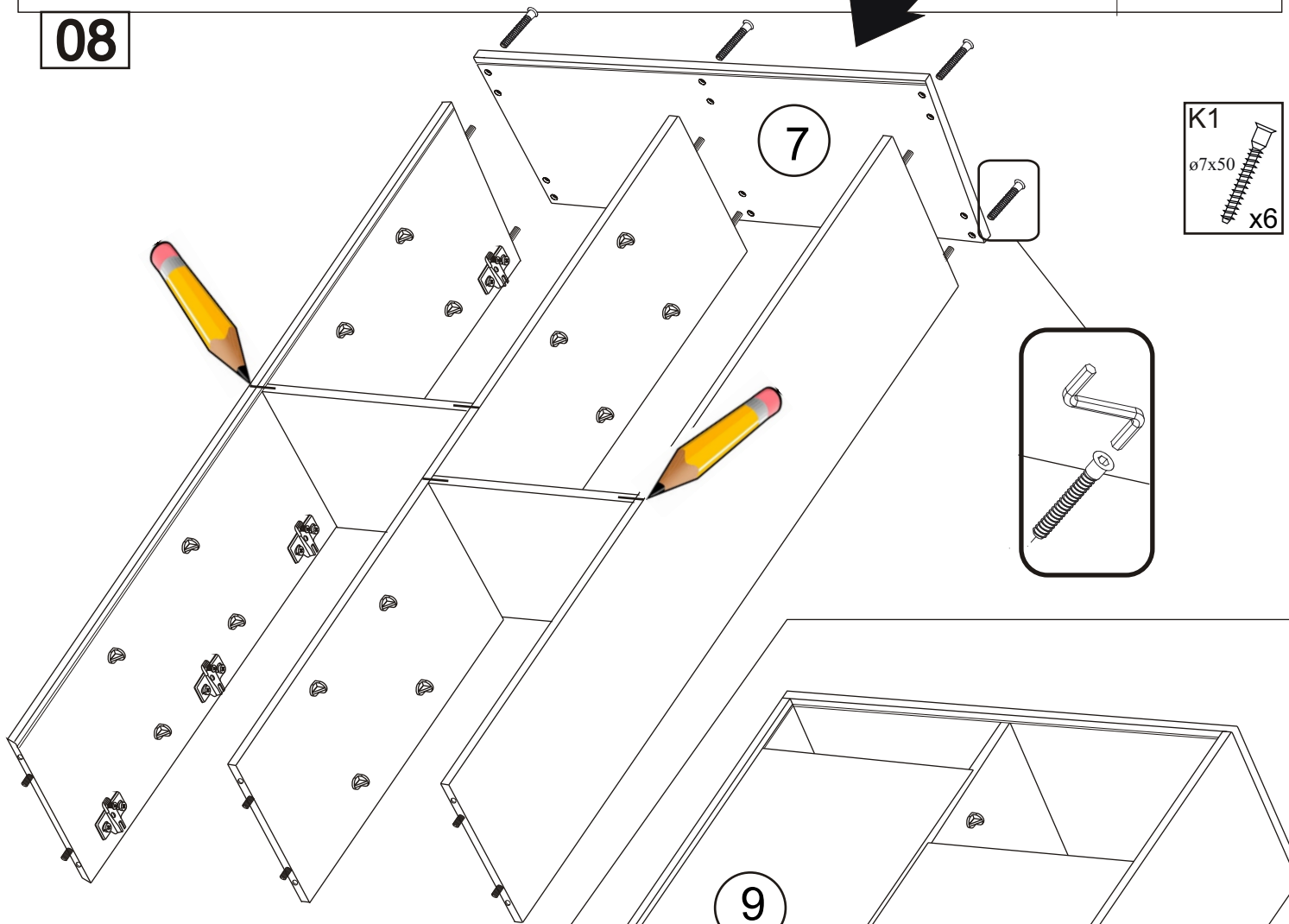

09

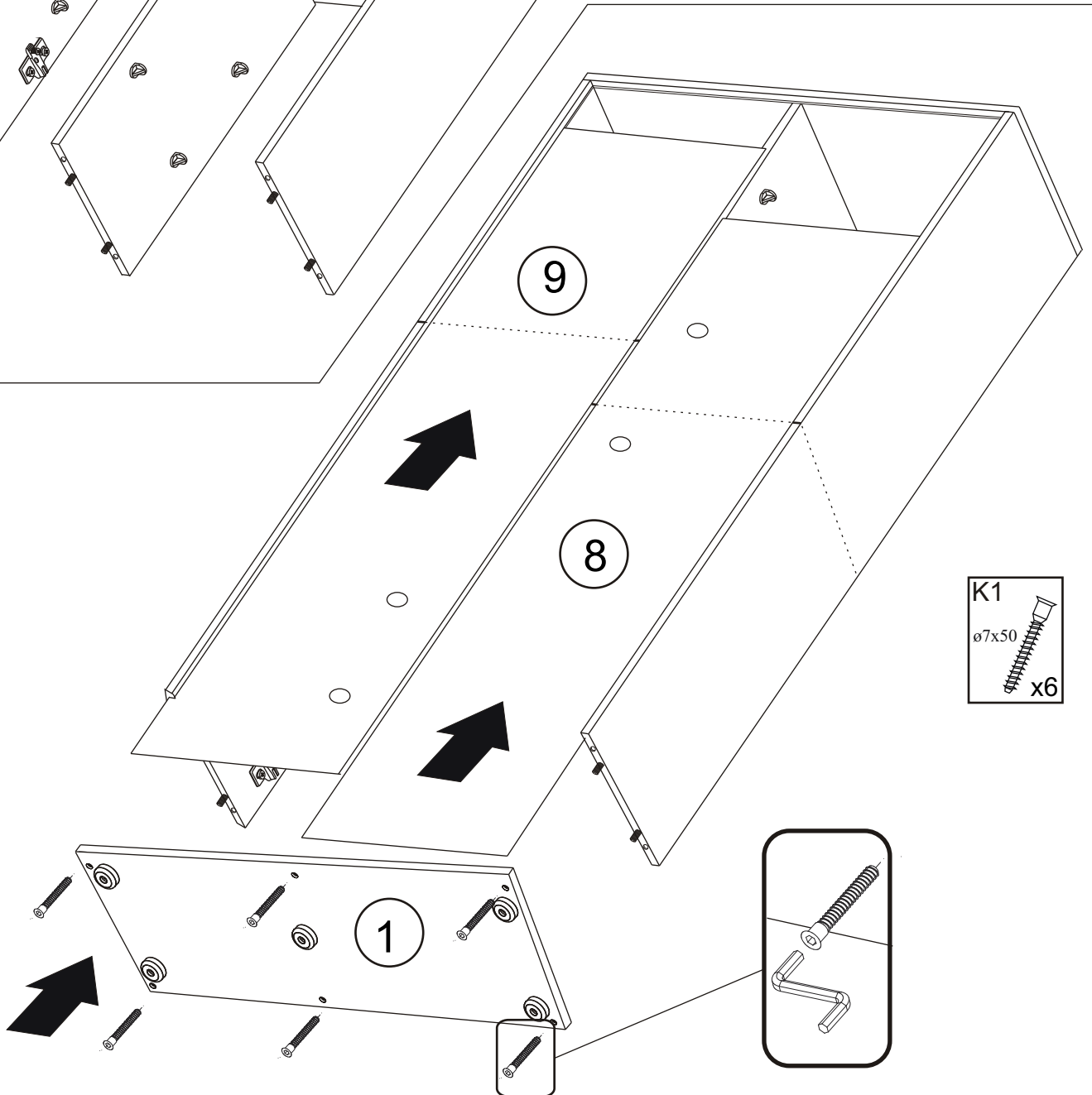

TRE VITRINE

8/12

10



A=B

A

B

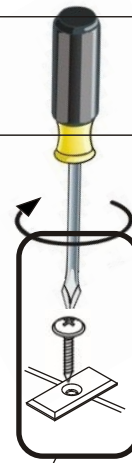

PL1



x12

W1

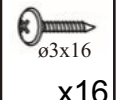

x16

S1

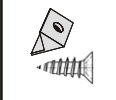

x12

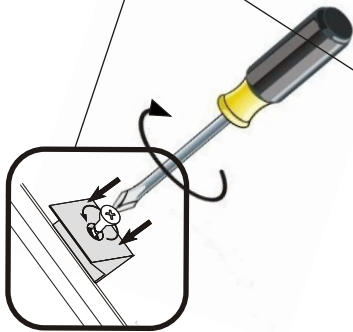

11

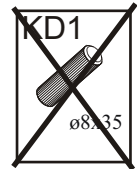
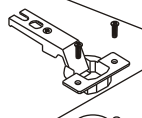
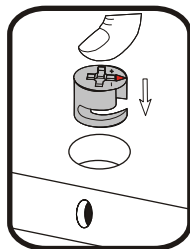

~~KD1~~



x4

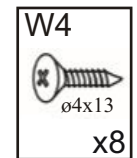

W4



x4

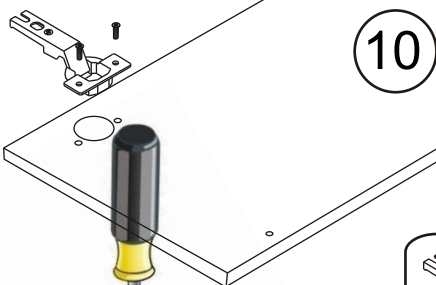

10

11

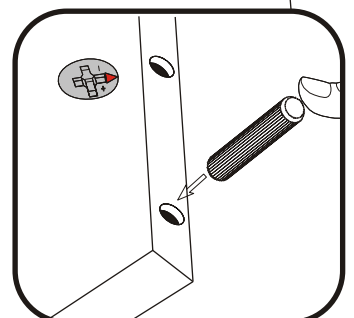
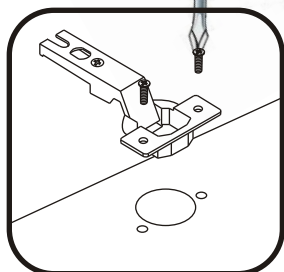

12

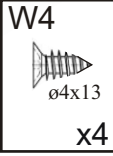
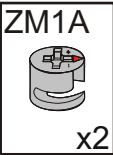
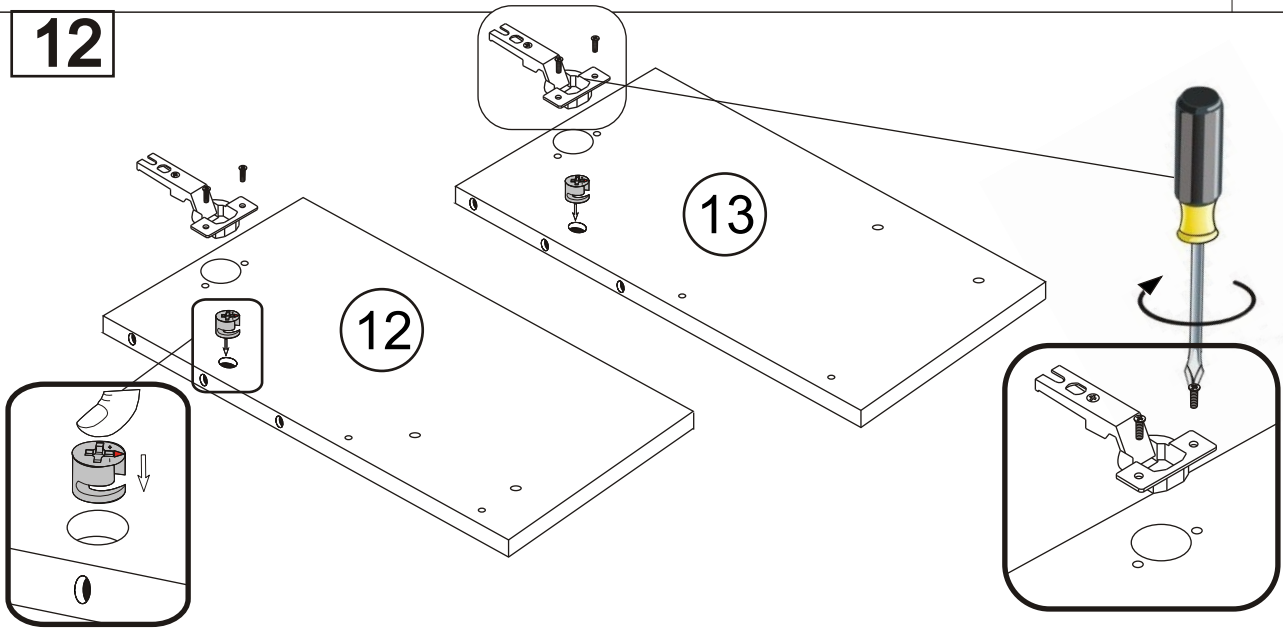

13

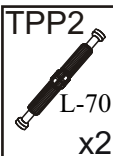
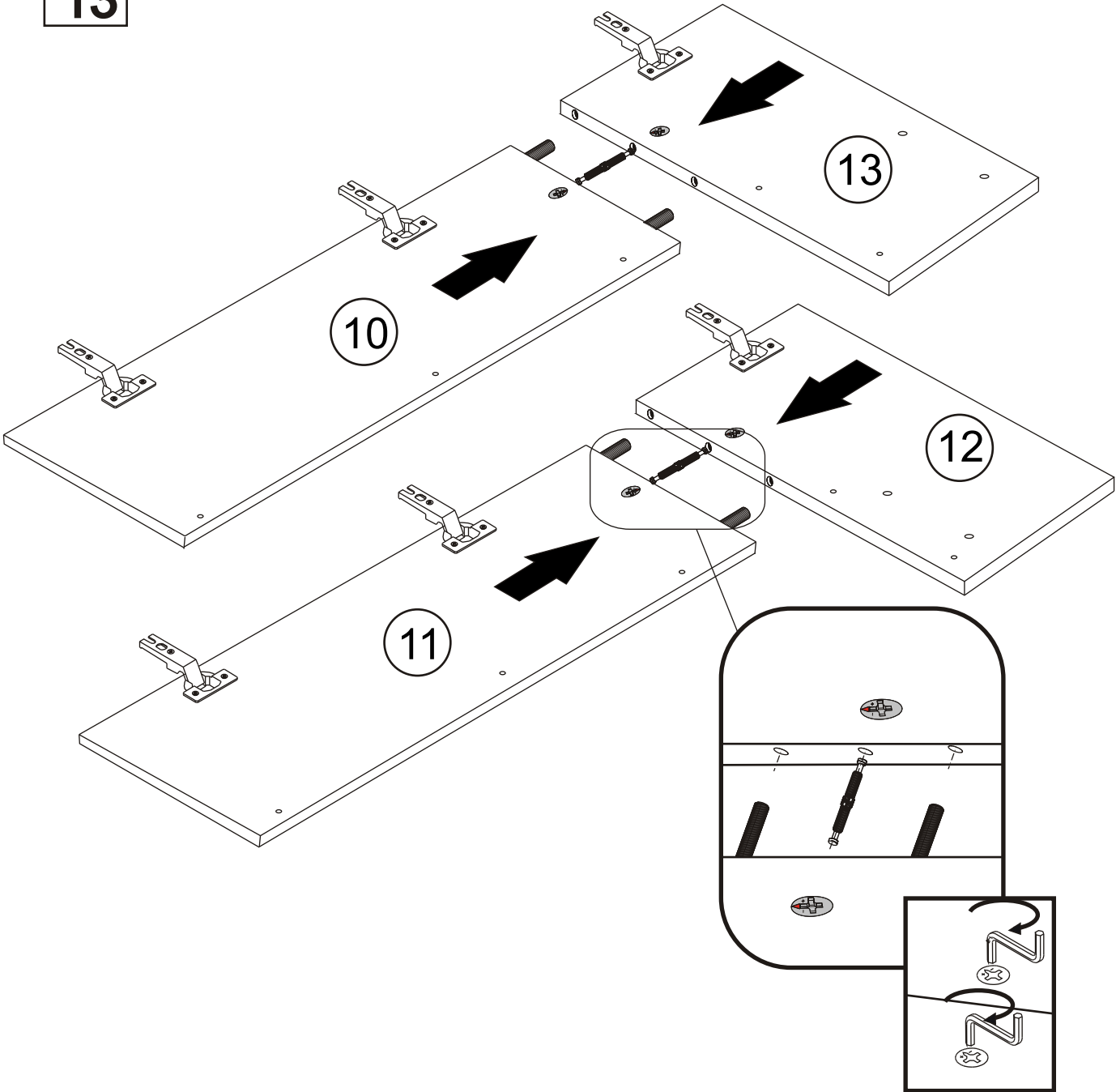

14

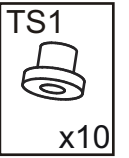
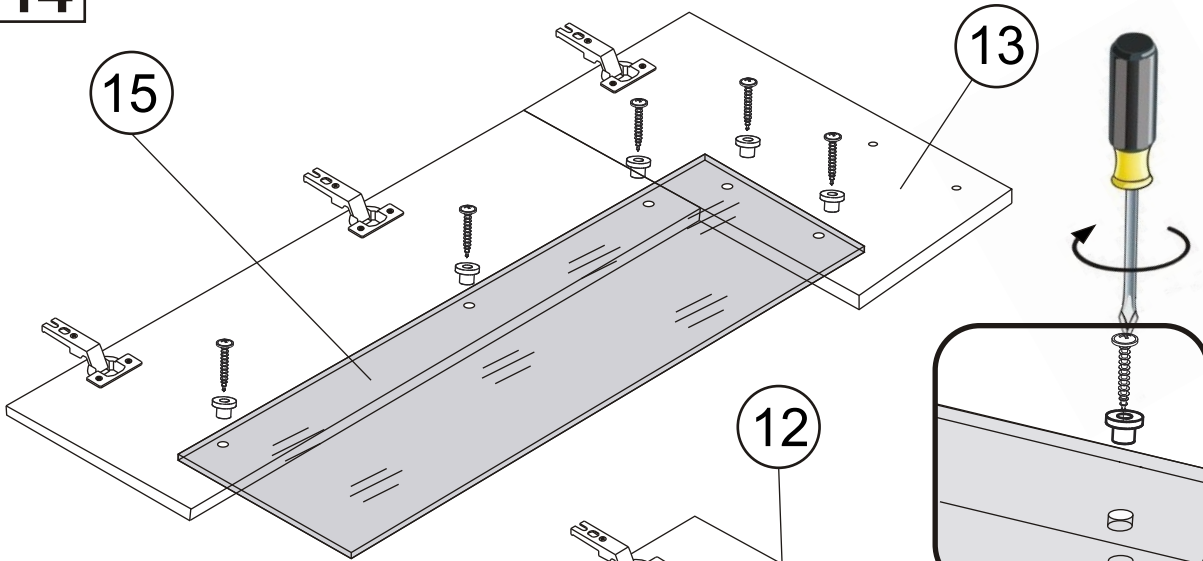

12

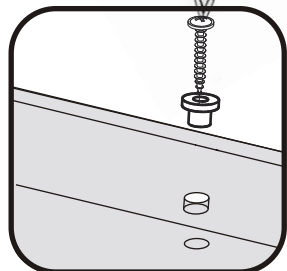

14

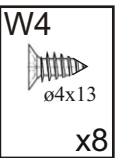
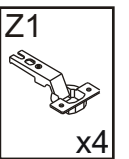
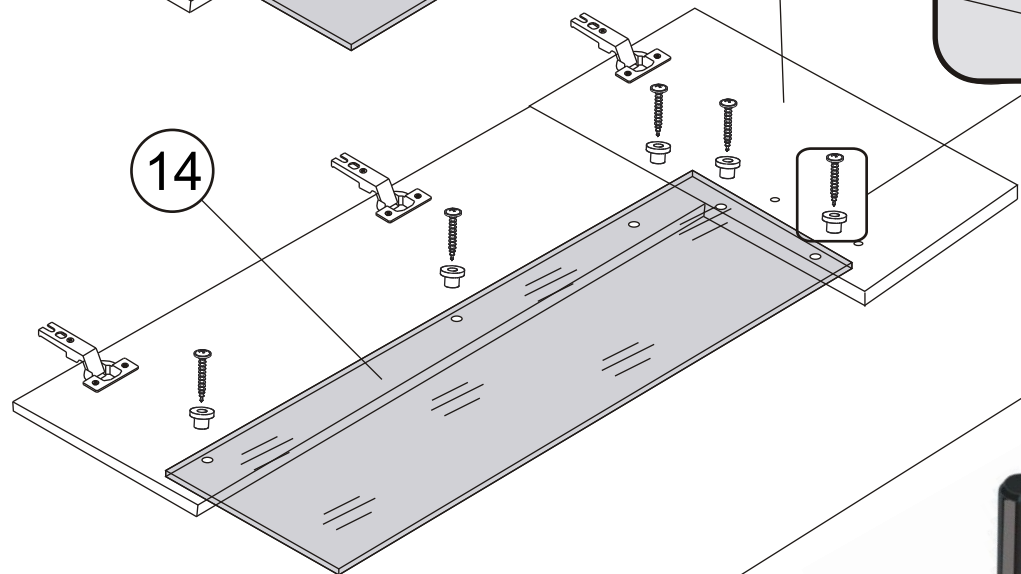

15

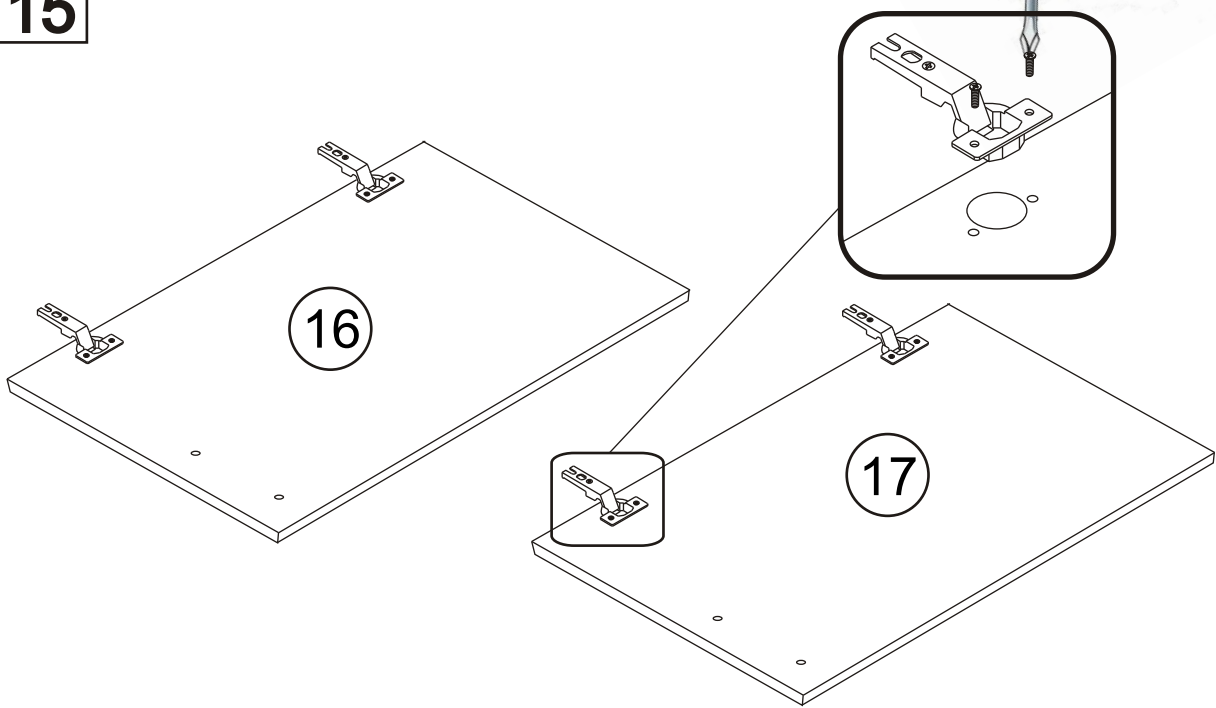

16

17

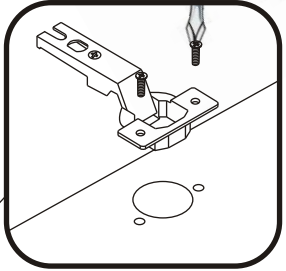

16

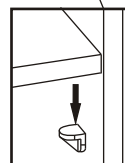
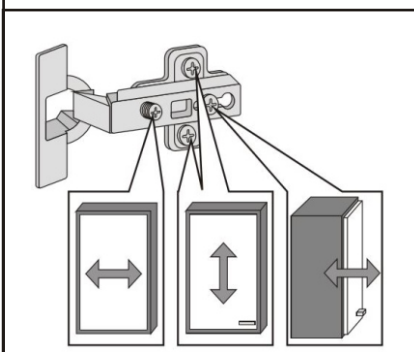
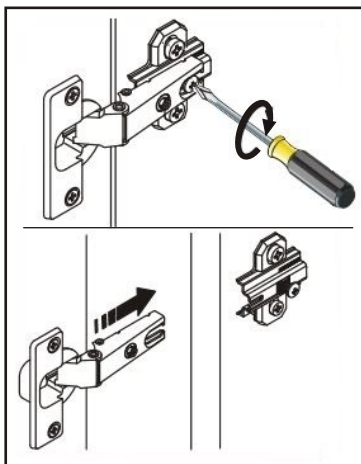
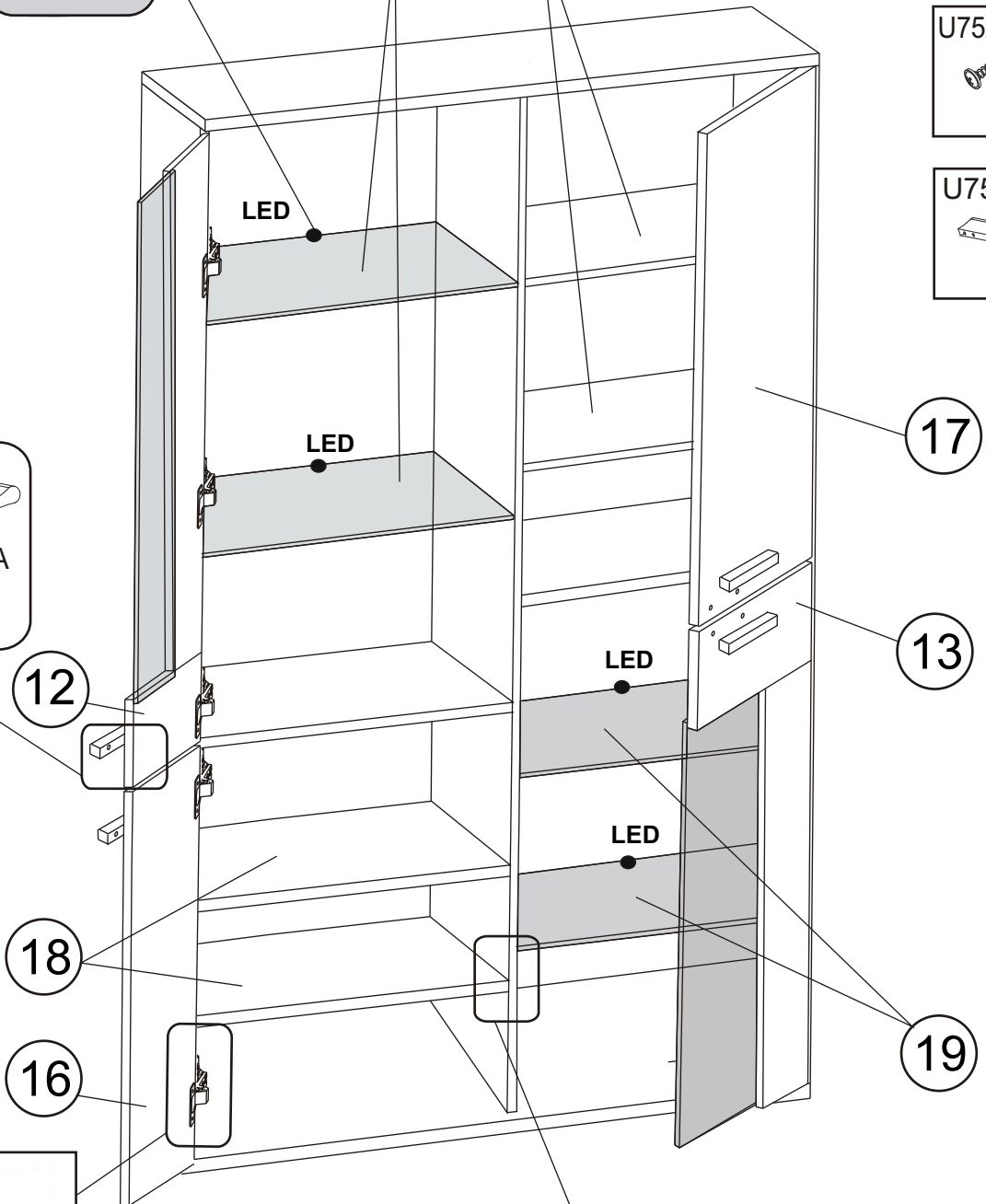
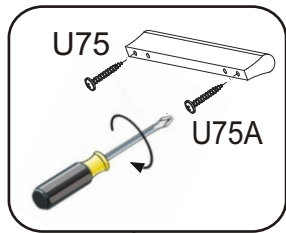
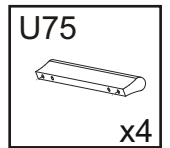
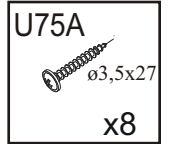
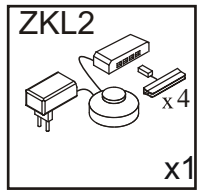
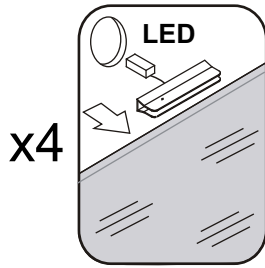

17

