

QUADRO 3 -3/5

35-363-...

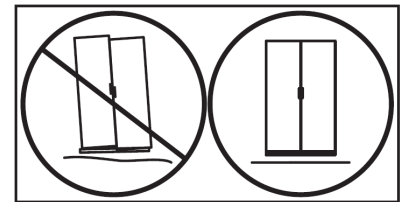

1/2	EL-QUA-3-DACH-D-DB	8	x1	1098	330	22
	EL-QUA-3-DACH-G-DB	7	x1	1098	330	22
	EL-QUA-3-WIENIEC-L/P-BI	4	x8	340	328	16
	EL-QUA-3-WIENIEC-S-BI	1	x4	340	328	16
	EL-QUA-BOCZ-SZ-L-BI	11	x3	290	240	16
	EL-QUA-BOCZ-SZ-P-BI	12	x3	290	240	16

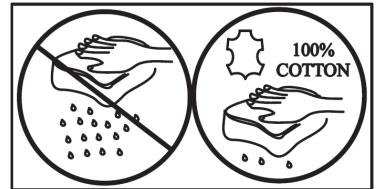
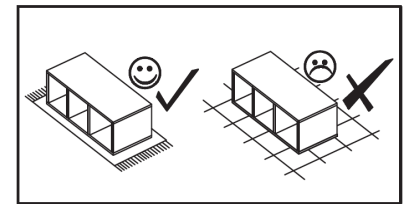
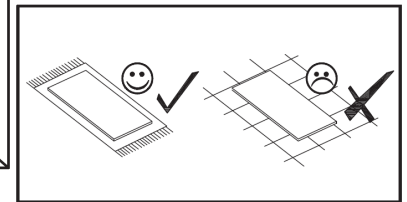
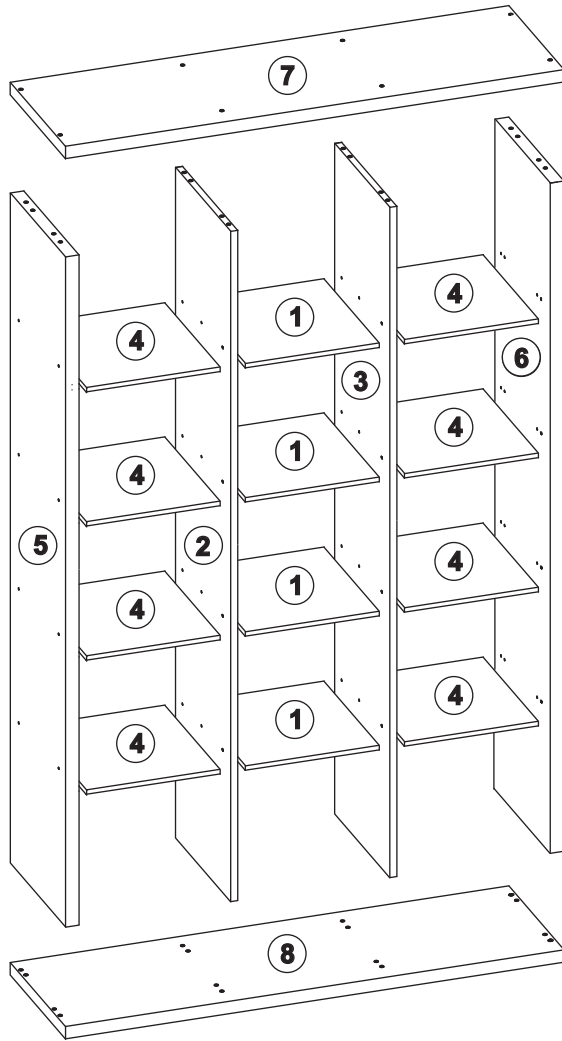
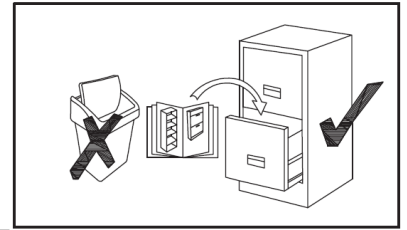
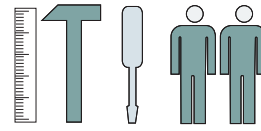
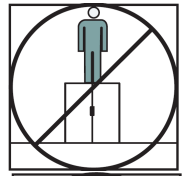
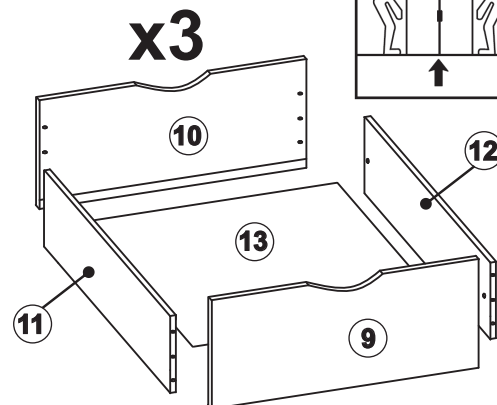

2/2	EL-QUA-3-BOK-L-DB	5	x1	329	1764	22
	EL-QUA-3-BOK-P-DB	6	x1	329	1764	22
	EL-QUA-3-PRZEG-L-BI	2	x1	329	1764	16
	EL-QUA-3-PRZEG-P-BI	3	x1	329	1764	16
	EL-QUA-DNO-SZUFL-HDF-BI	13	x3	305	315	3
	EL-QUA-FRO-BI	10	x3	335	335	16
	EL-QUA-FRO-DB	9	x3	335	335	16

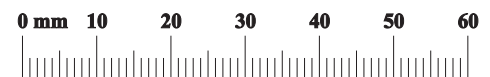

E1 x12	E2 x28	E3 x28	E5 x8	H1 x32	H3 x24	W6 x1
L1 x1	W4 x2	W5 x1	W7 x6	K1 x56	K2 x16	O1 x1

01

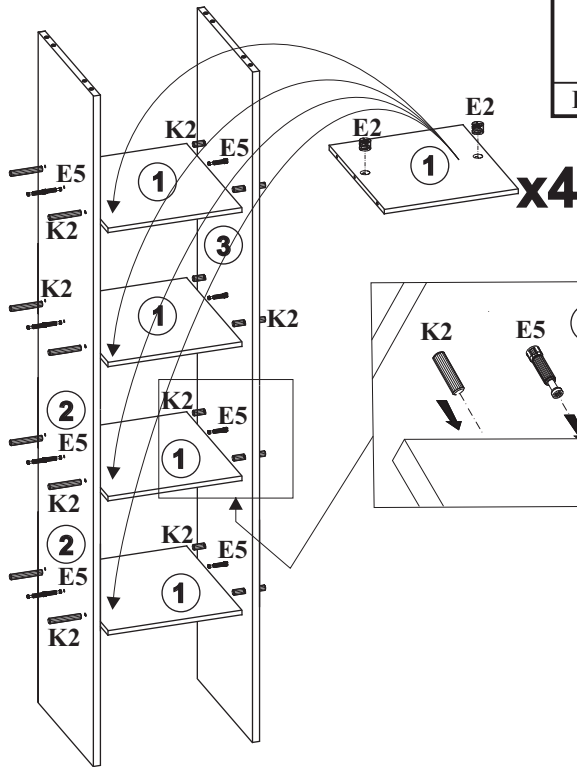
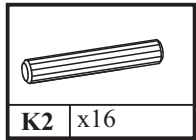
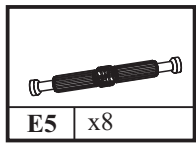

	15x12,5		
E2	x8	E3	x8

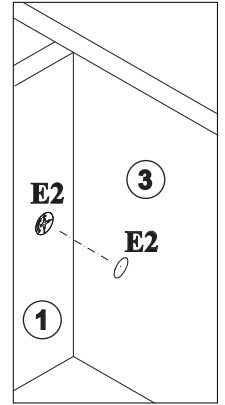
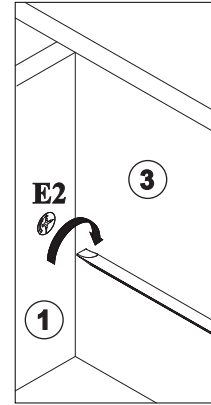
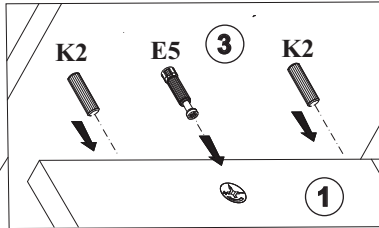

02

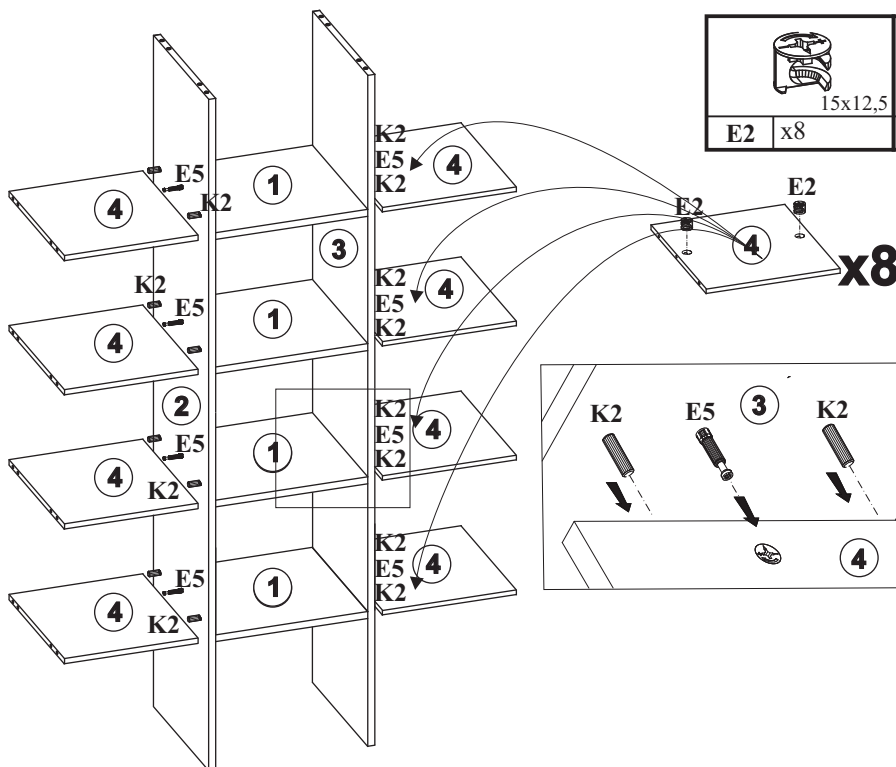

	15x12,5		
E2	x8	E3	x8

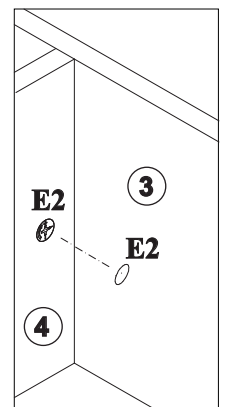
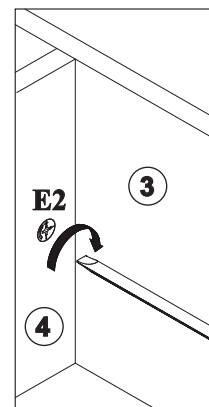
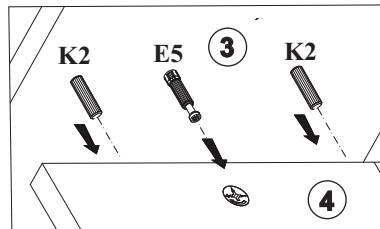

03

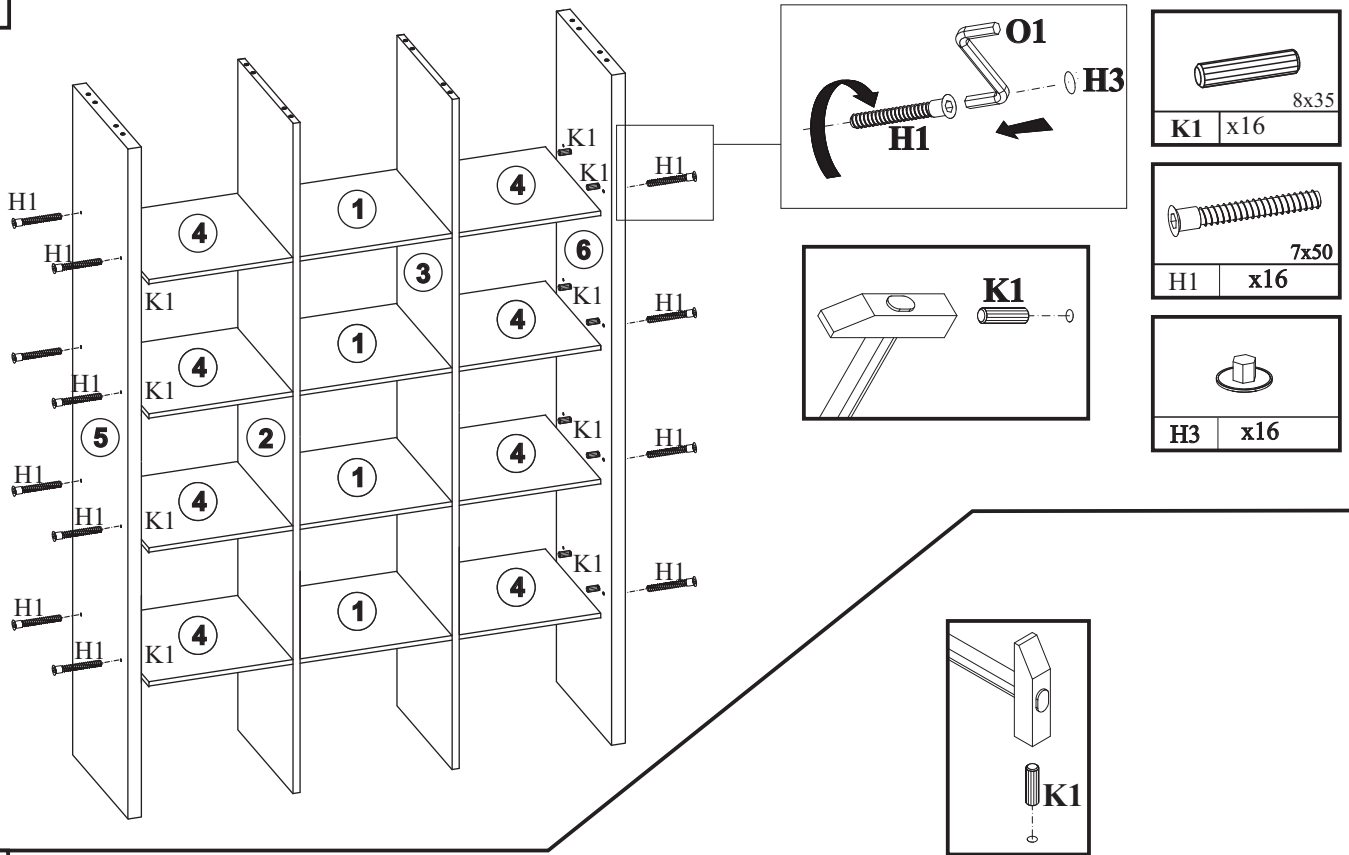

04

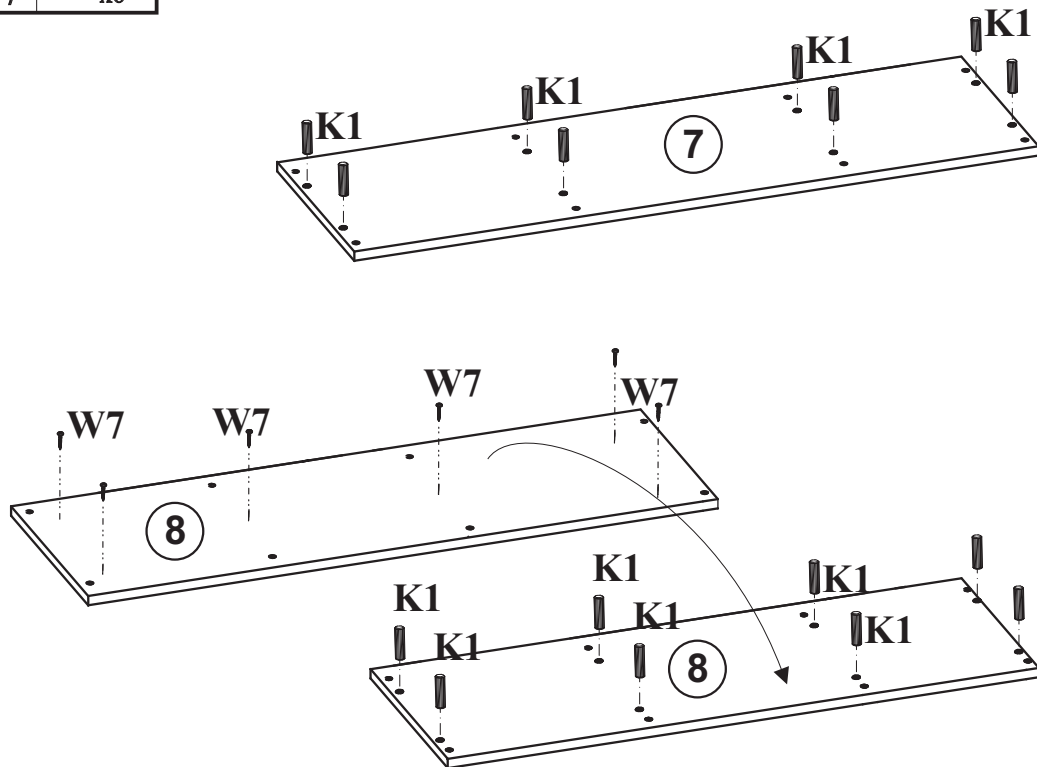
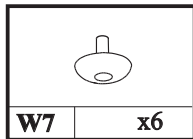

05

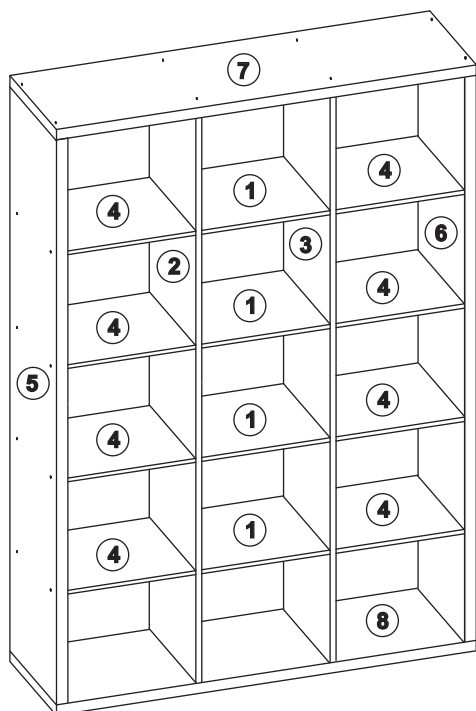
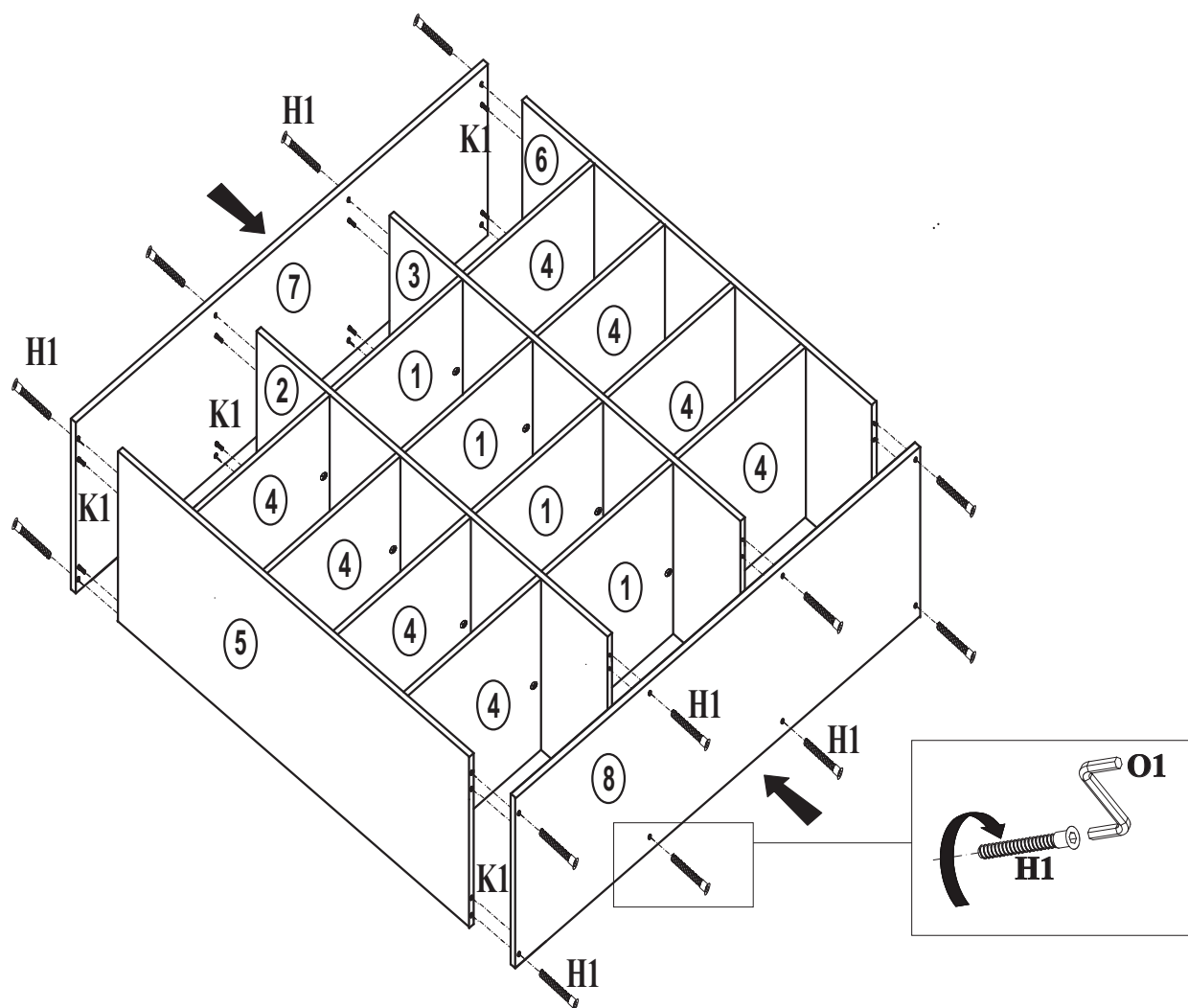

06

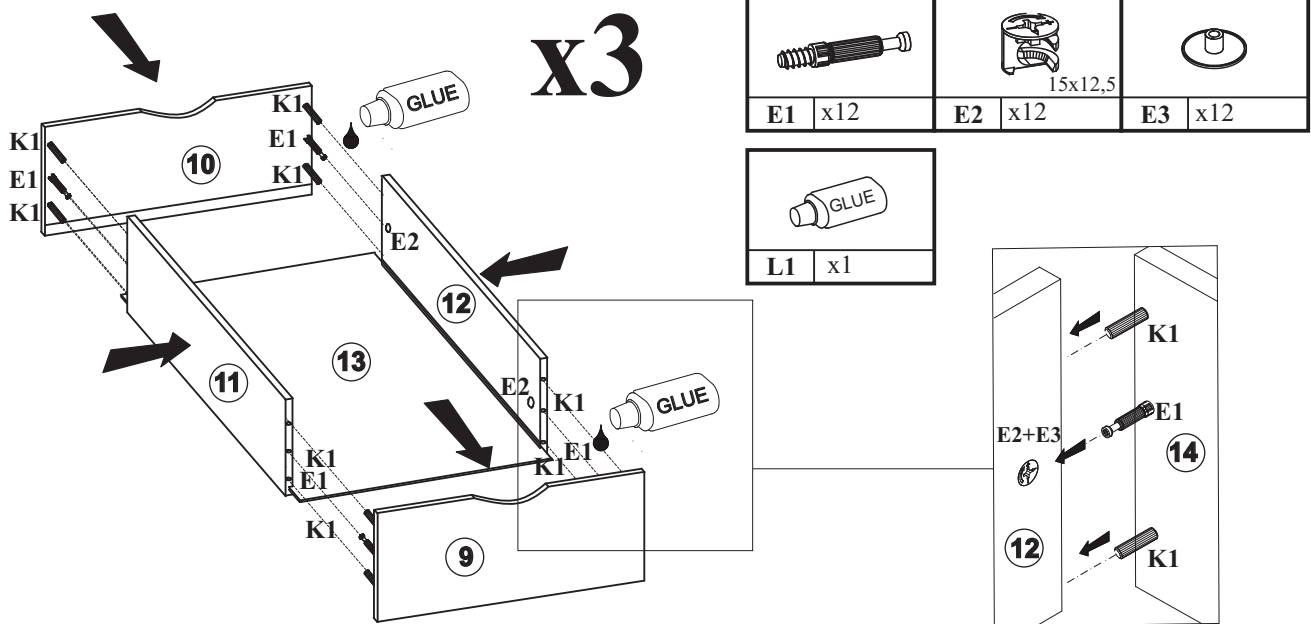

07

