

980479

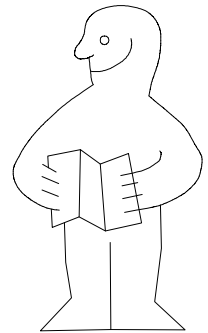

1-2-3-4...

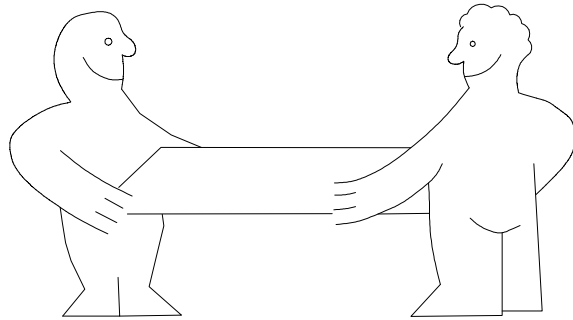

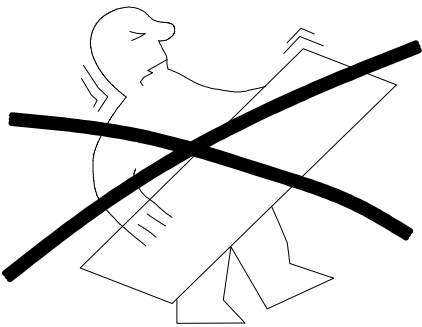
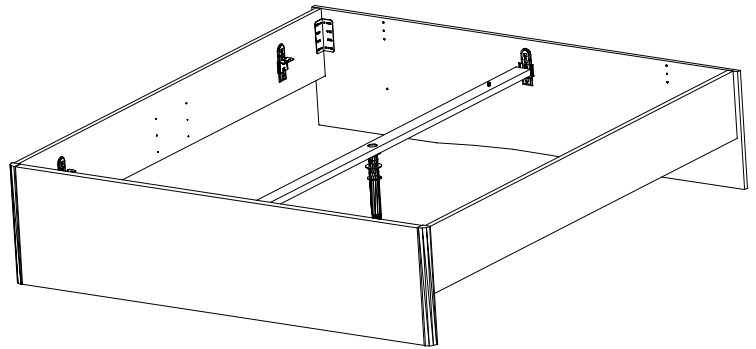
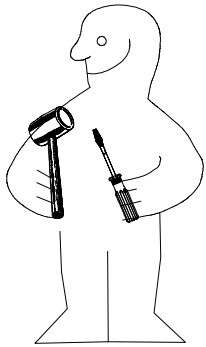
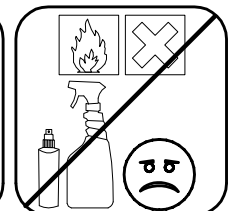
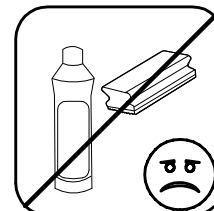
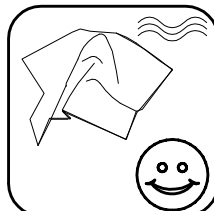
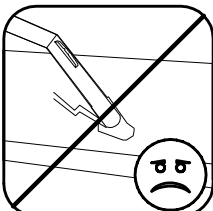
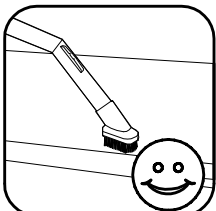
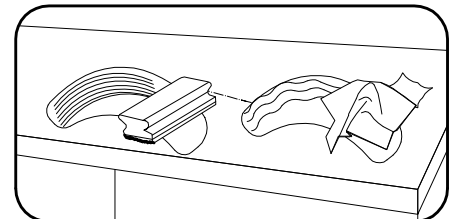
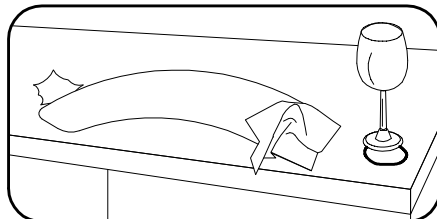
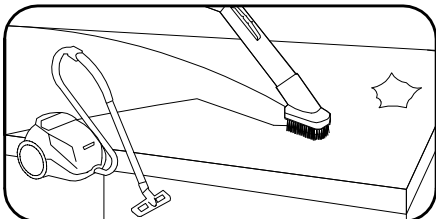
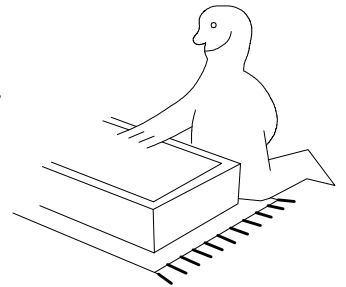
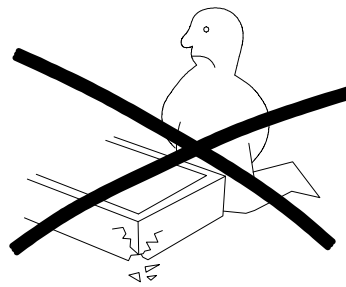
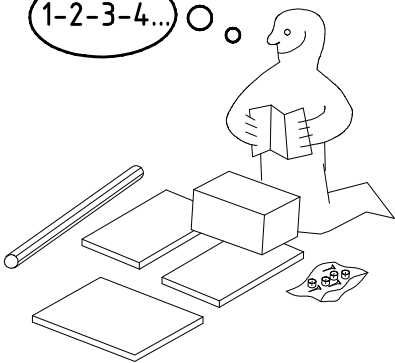





980479

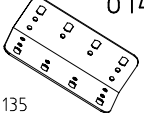

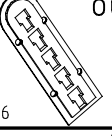
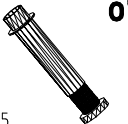
22.05.13 / 11.09.17



09 17

1/5

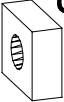
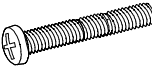
 111 135	014 4 x
 111 627	07 6 x
 111 626	06 6 x
 111625	09 1 x

 121 130	4 X 20 mm G22 16 x
 121 110	4,0 x 15 mm G23 20 x
 121 148	6,0 x 12 mm G4 6 x
 111634	09A 2 x

 129 407	US 4 x
 121 150	G6 4 x
 121 149	5,0 x 35 mm G51 4 x
 111 112	φ 10 x 13 mm H 6 x

 121 121	4 X 20mm SP20 16 x
 353 018	D 2 x

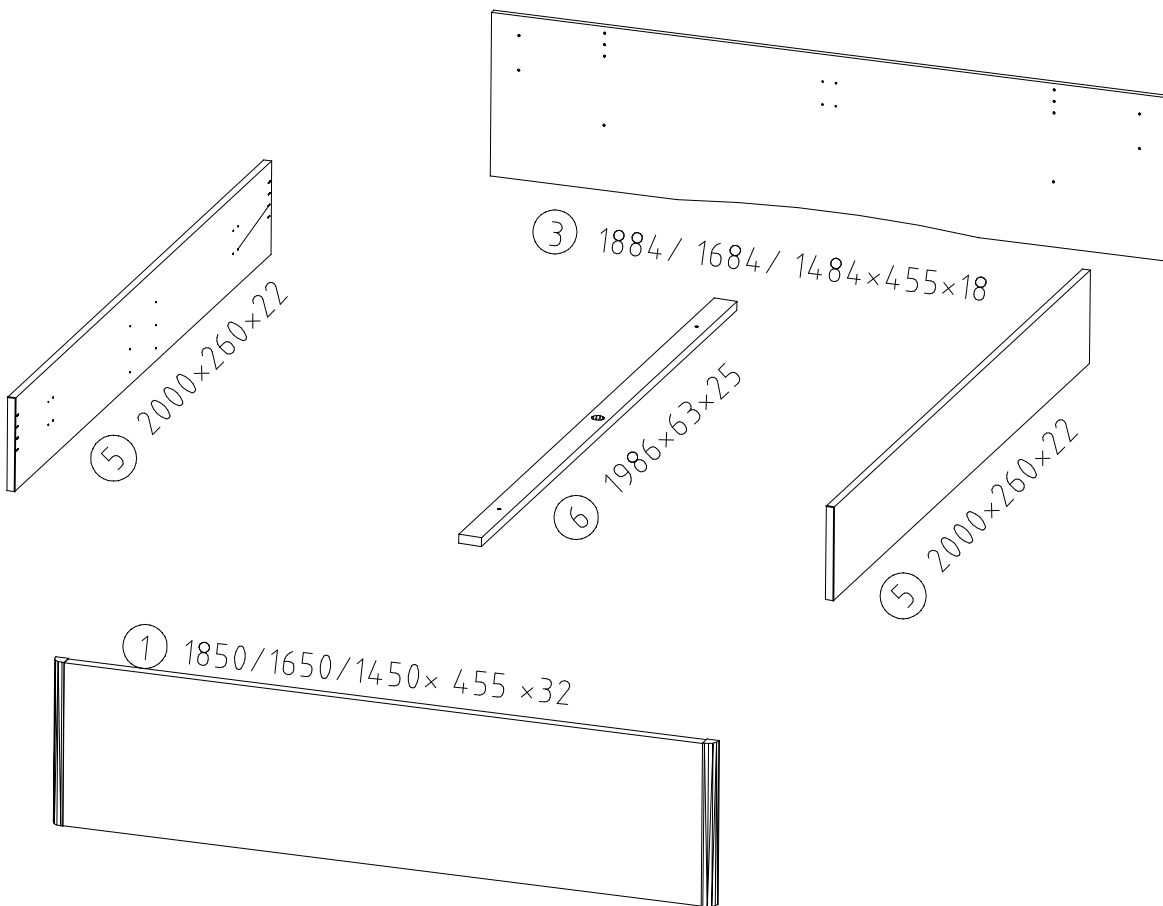
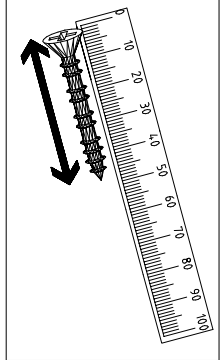
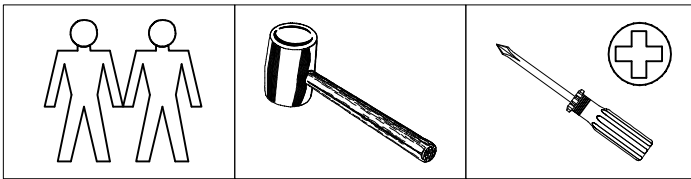
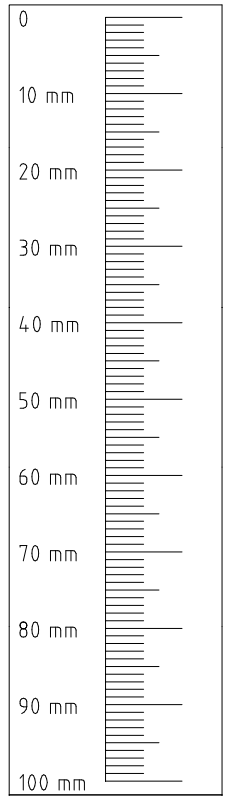

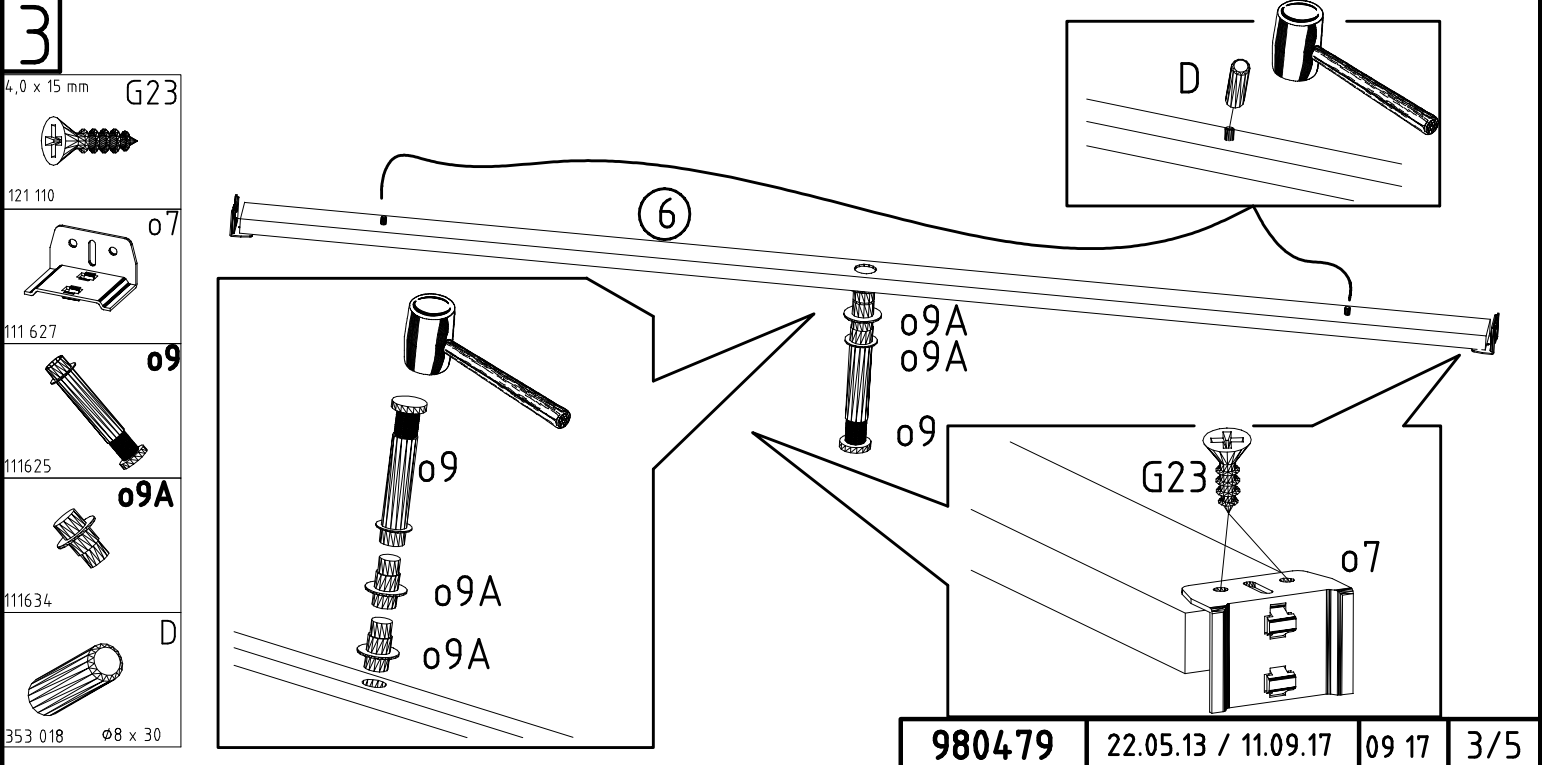
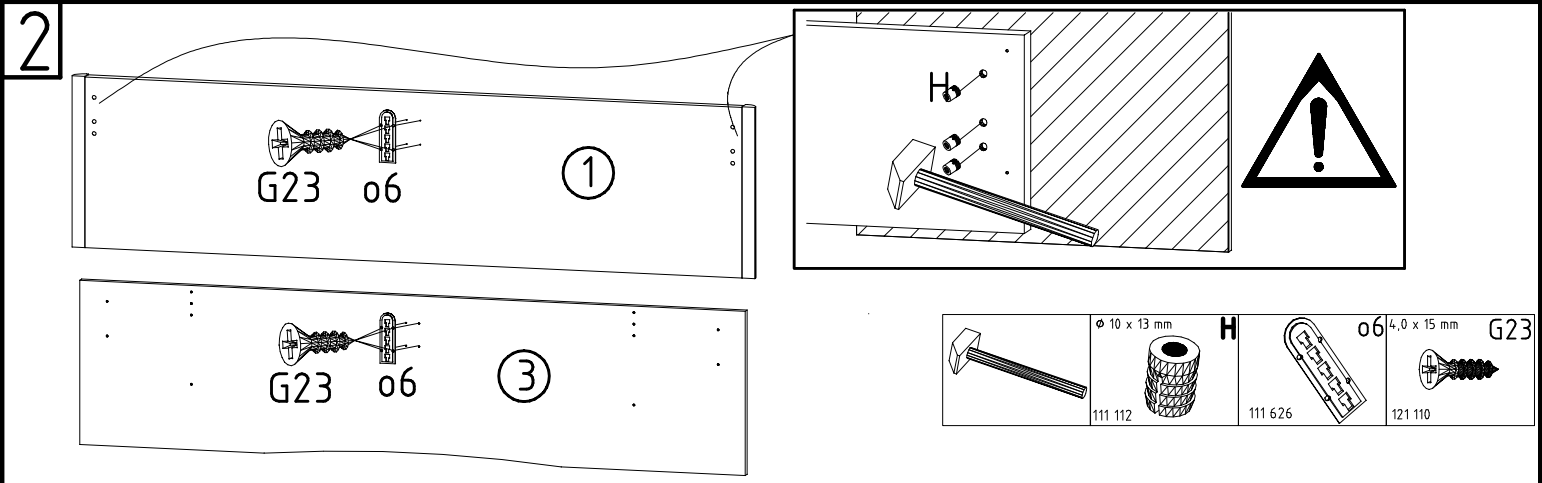
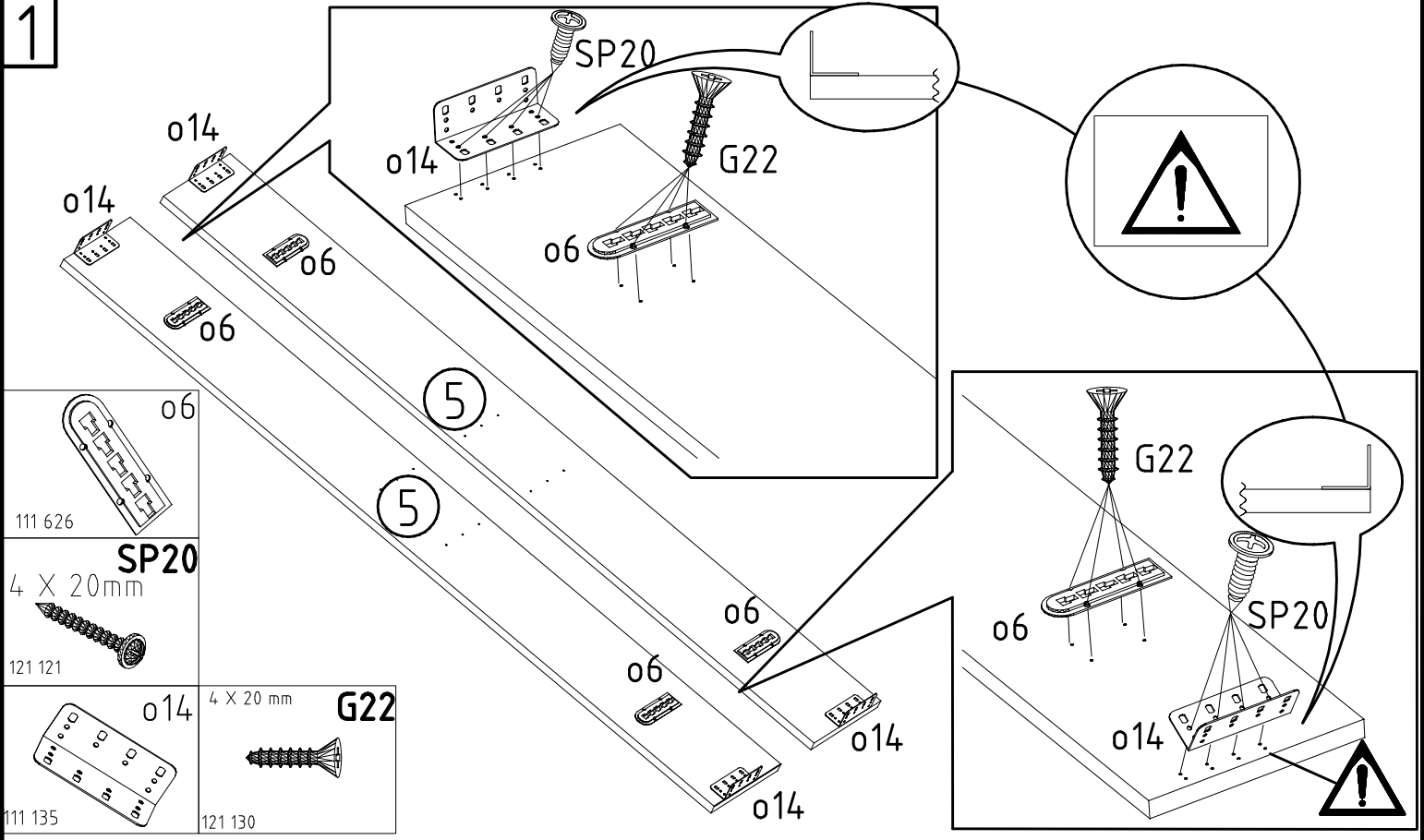

4

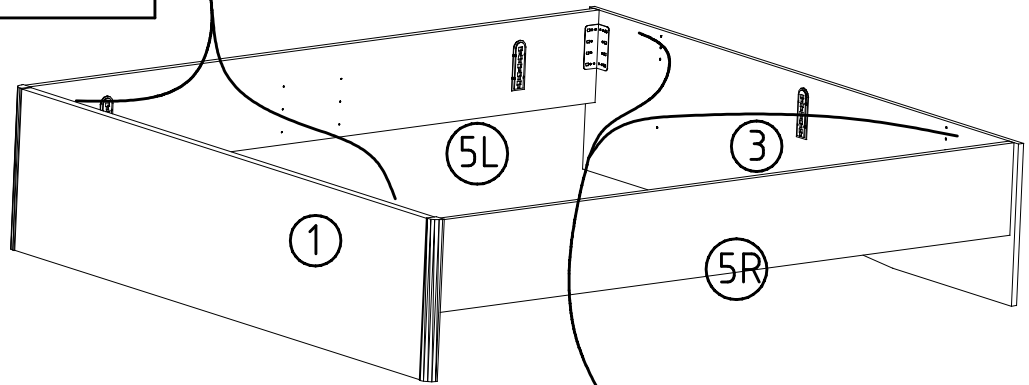
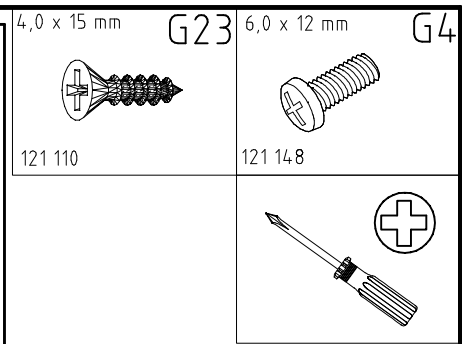
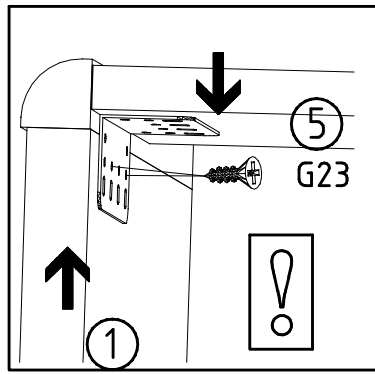
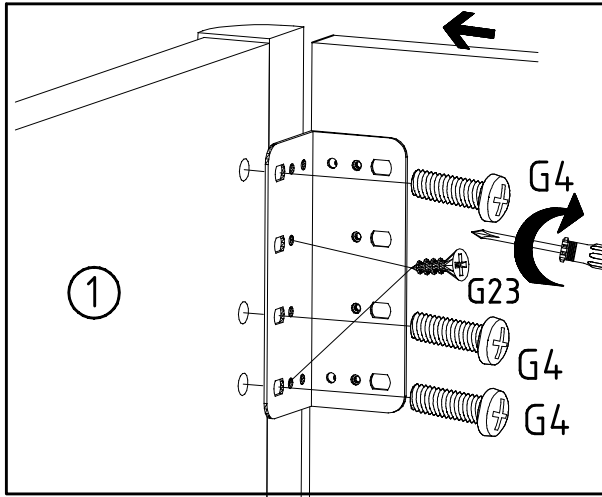

5

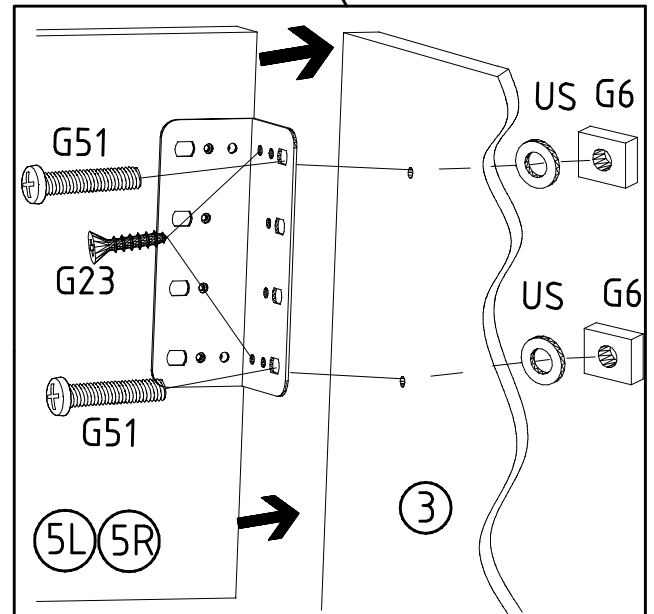
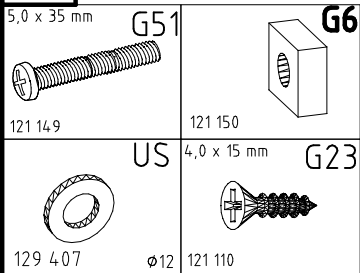

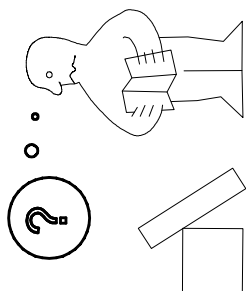
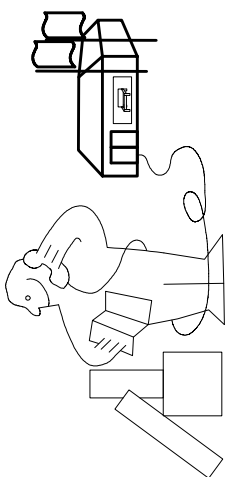
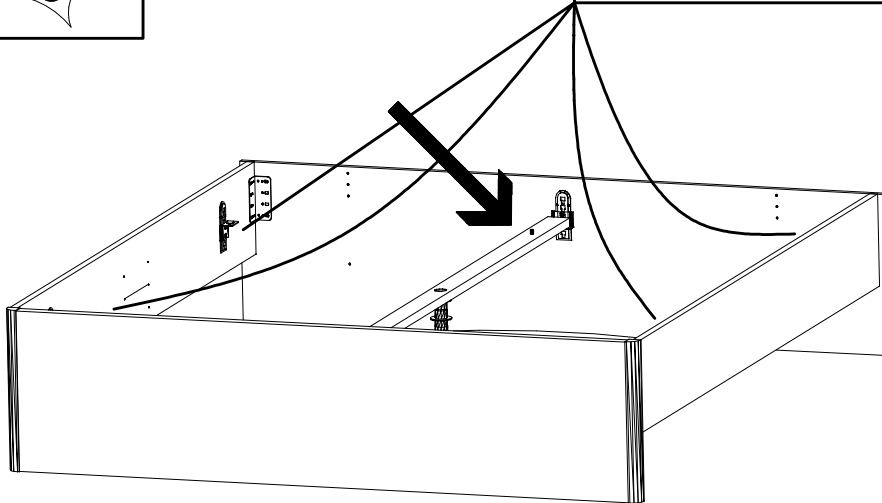
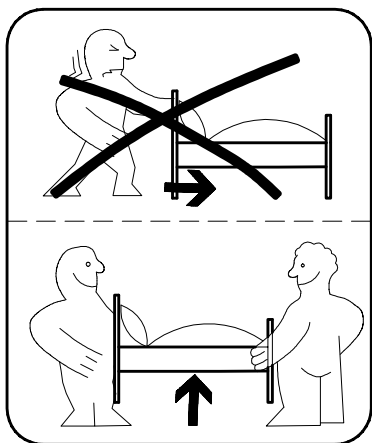
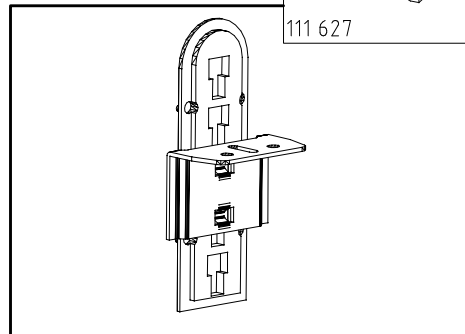
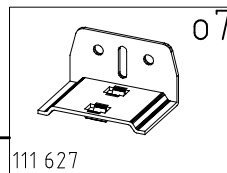
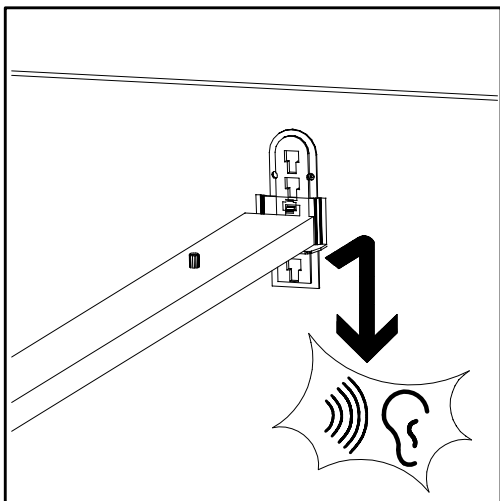

Modell/Model/Modèle

--	--	--	--	--	--

5

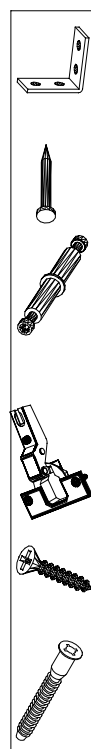

(121 370)	(G 1)	(4x)

Änderungen die dem technischen Fortschritt geschuldet sind, behalten wir uns vor!
 Bei nicht vorschriftsmäßiger und/ oder nicht fachmännischer Montage wird bei Personen- und/ oder Sachschäden keinerlei Haftung übernommen.