

A

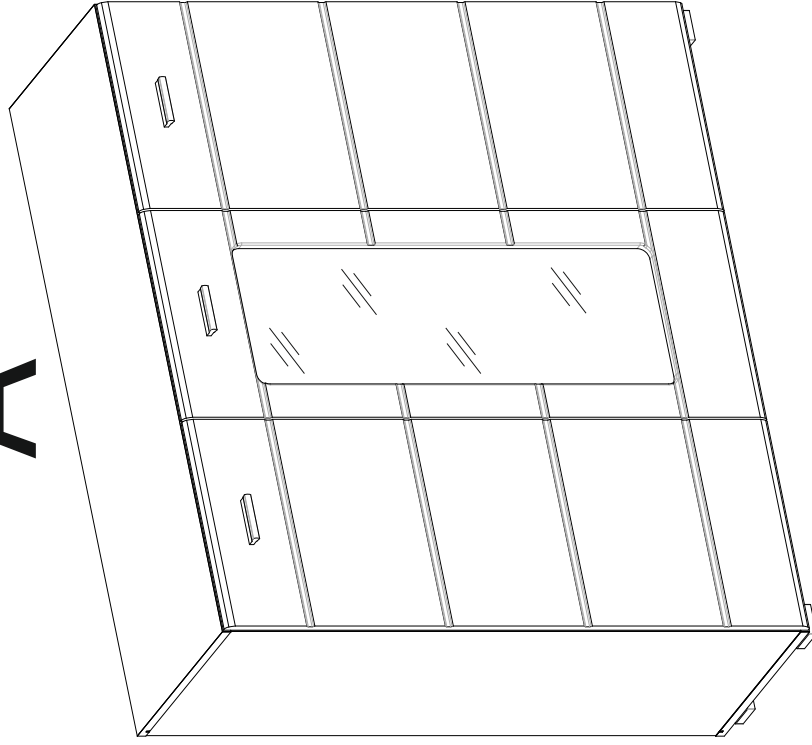

90 min

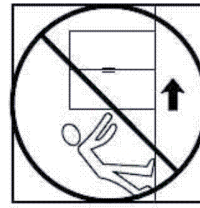

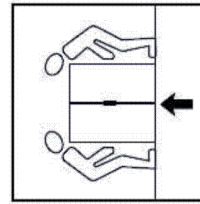
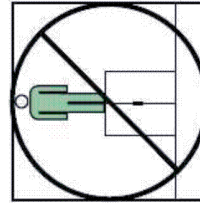
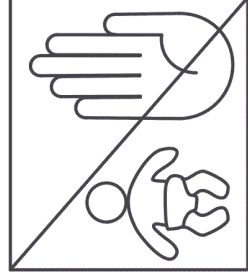
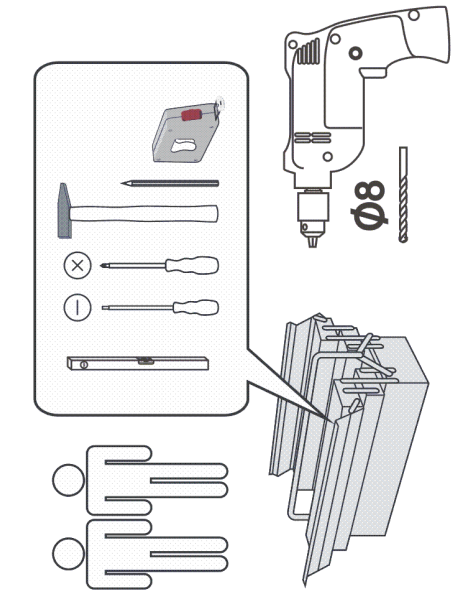
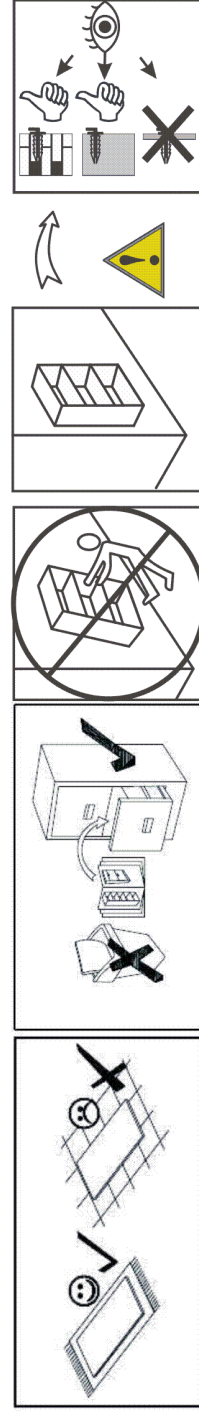
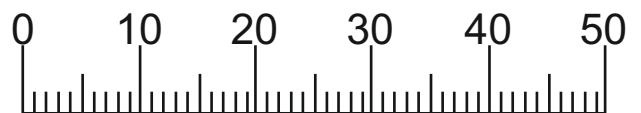
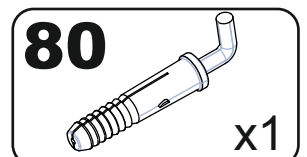
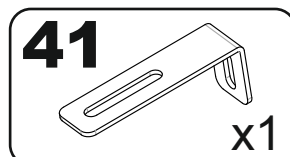
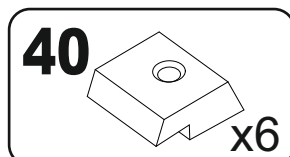
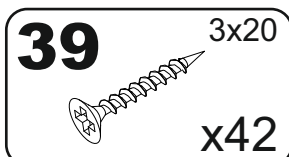
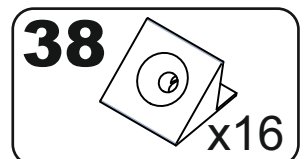
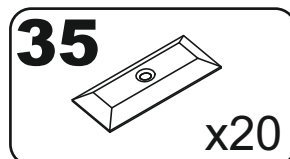
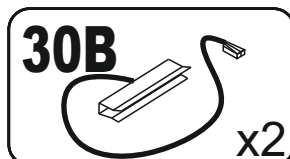
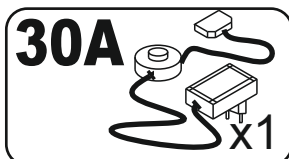
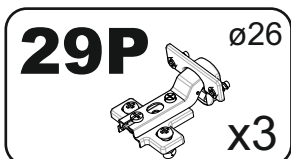
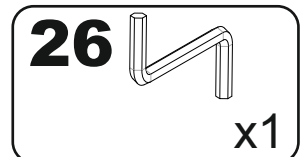
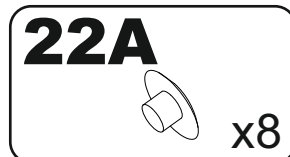
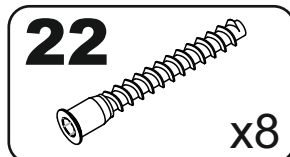
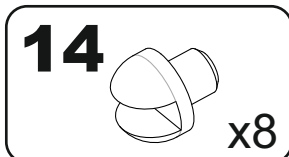
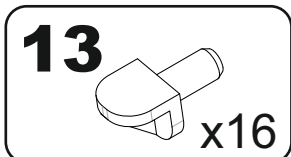
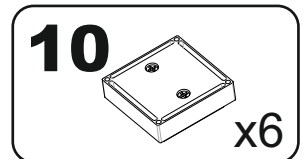
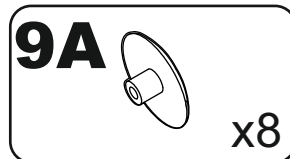
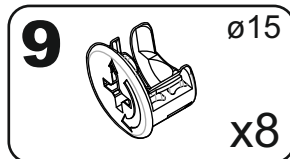
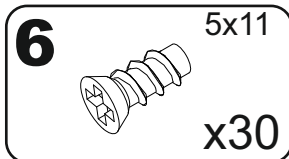
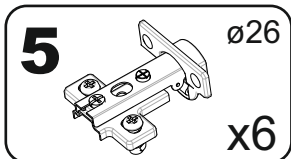
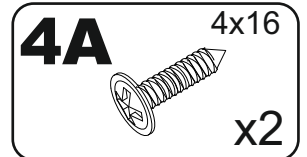
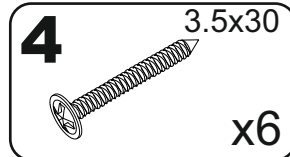
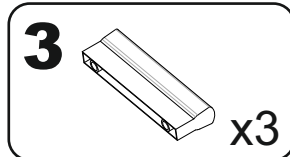
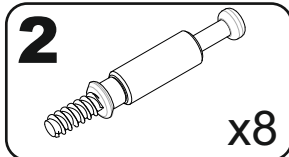
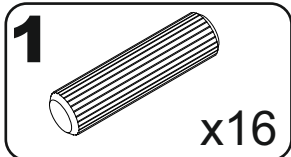
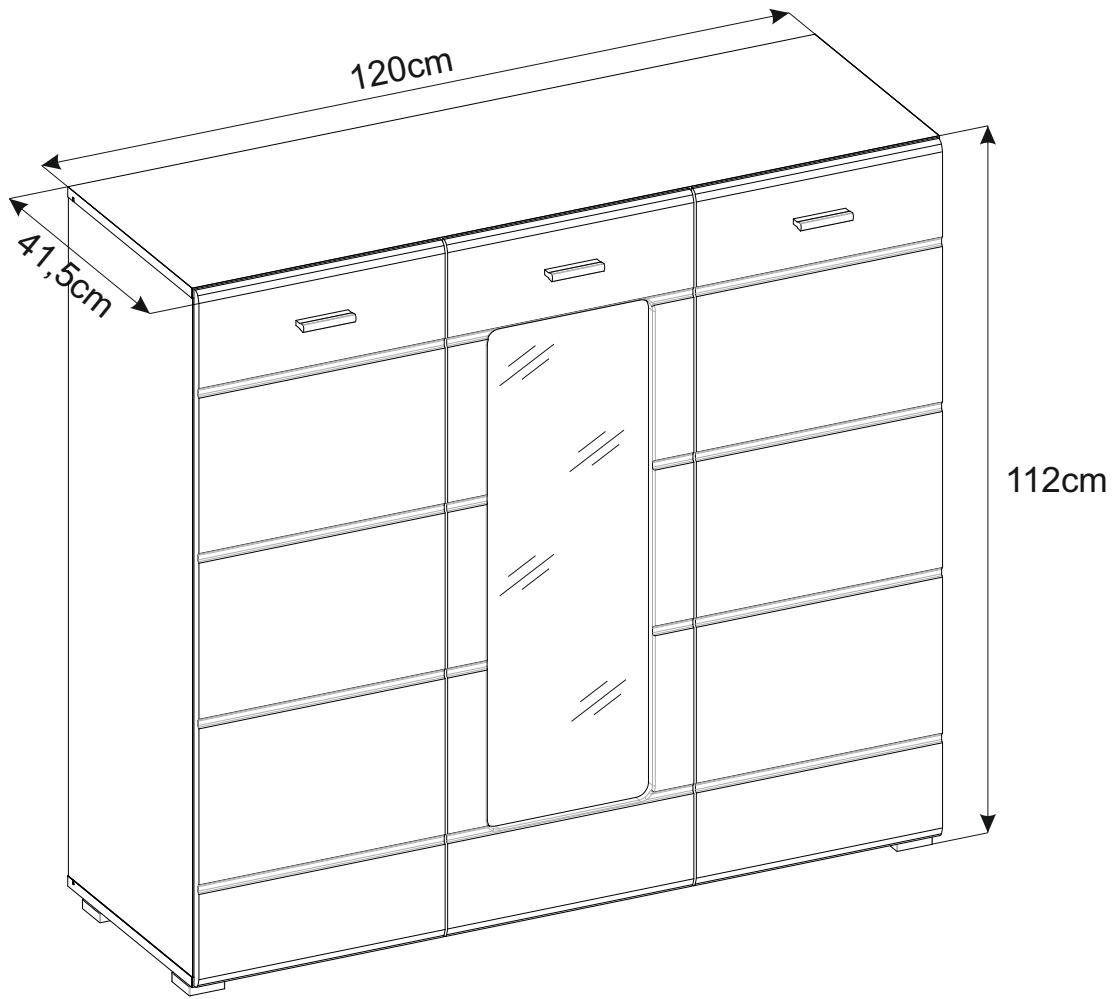

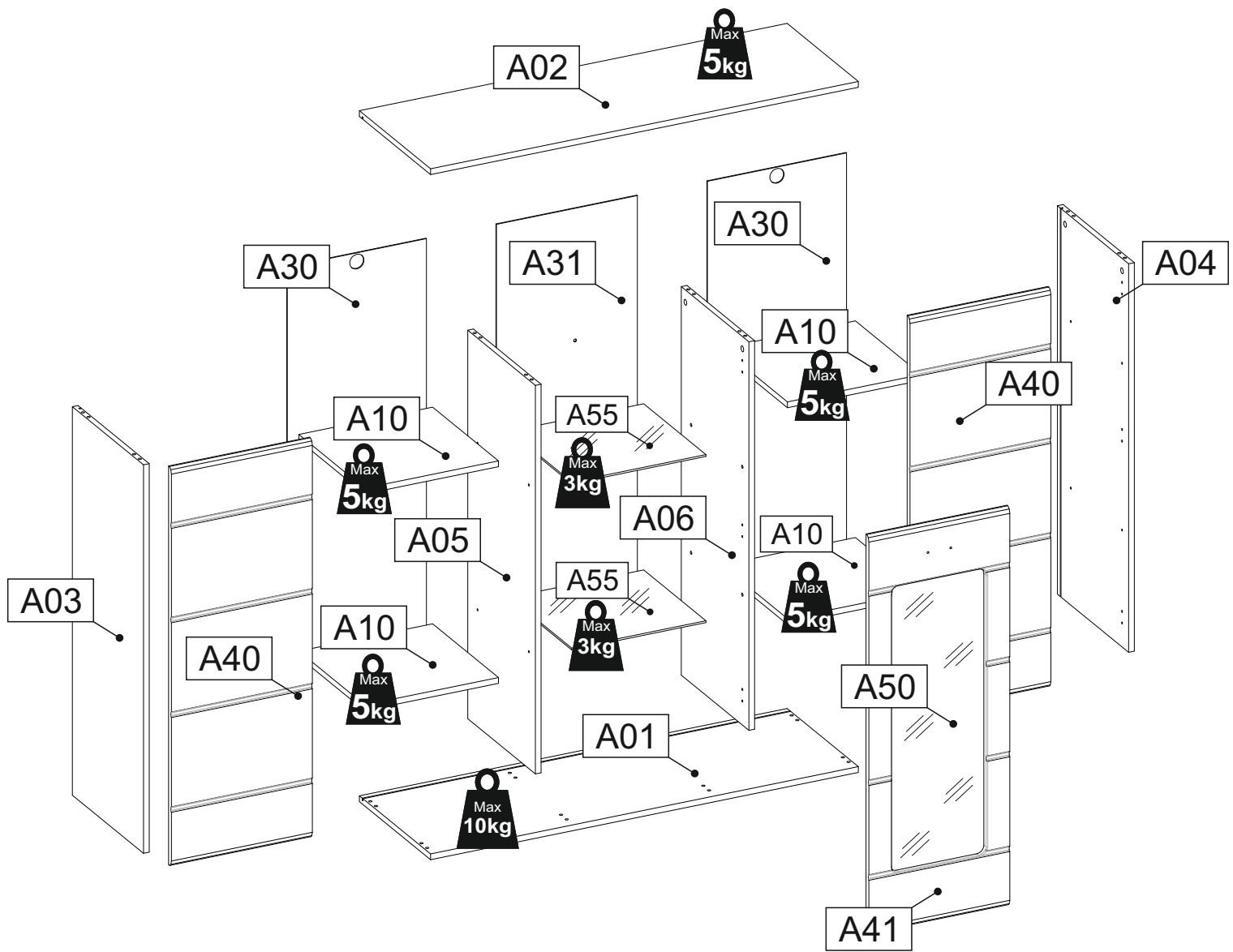

A	B_(mm)	C_(mm)	D_(mm)	E	F
A01	1202	400	16	1	1 2
A02	1202	400	16	1	1 2
A03	1070	400	16	1	1 2
A04	1070	400	16	1	1 2
A05	1070	380	16	1	1 2
A06	1070	380	16	1	1 2
A10	376	370	16	4	2 2
A30	1080	391	3	2	2 2
A31	1080	396	3	1	2 2
A40	1098	396	16	2	2 2
A41	1098	396	16	1	2 2
A50	898	306	4	1	2 2
A55	377	350	5	2	2 2

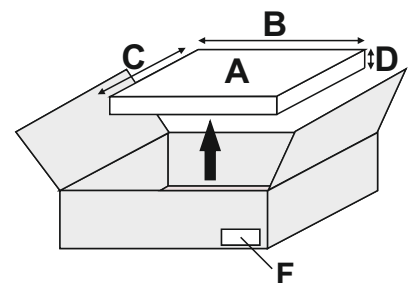
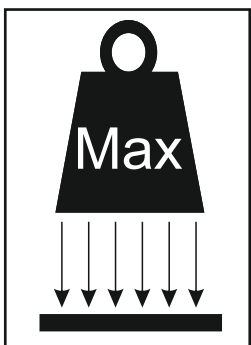

1

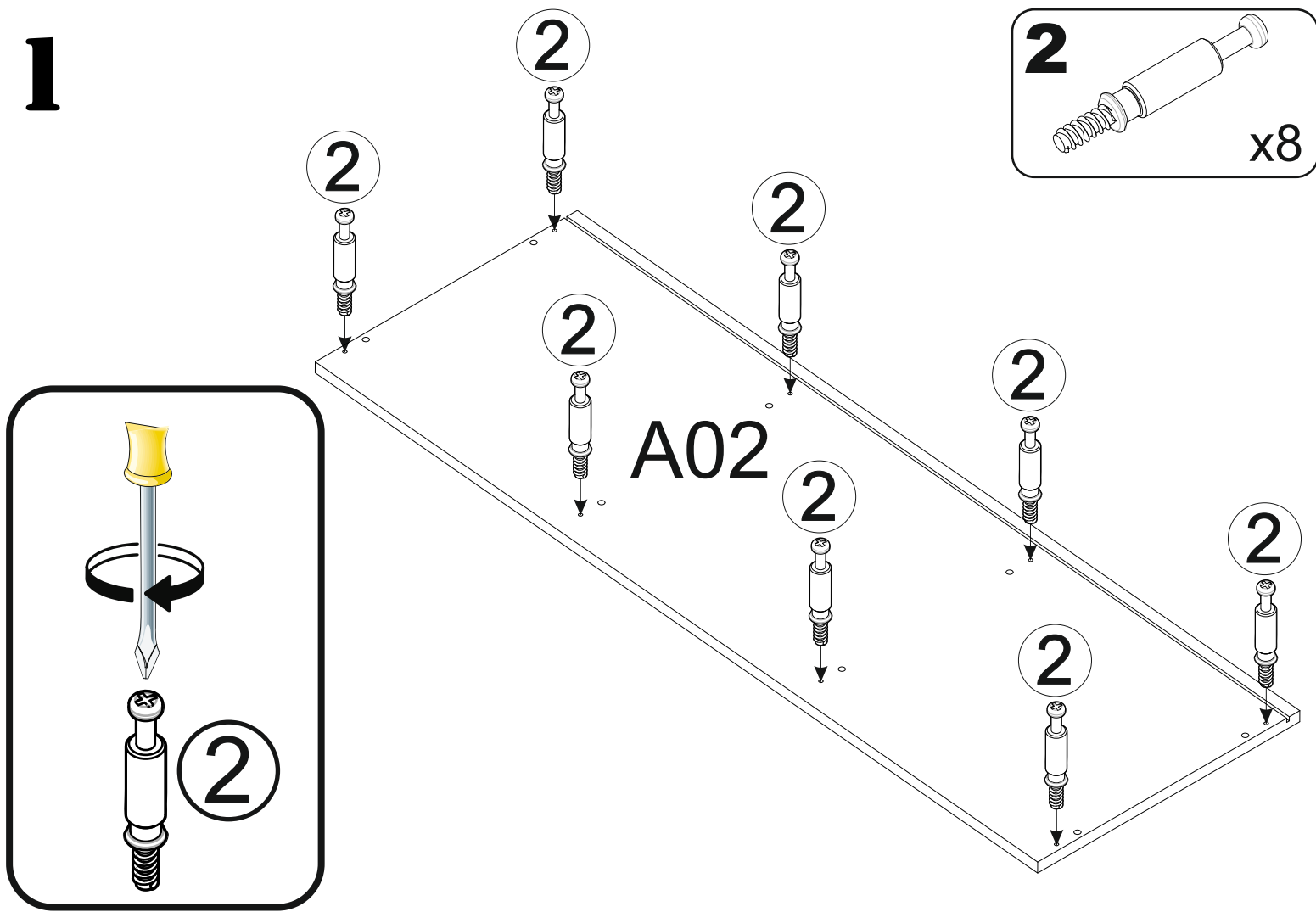

2

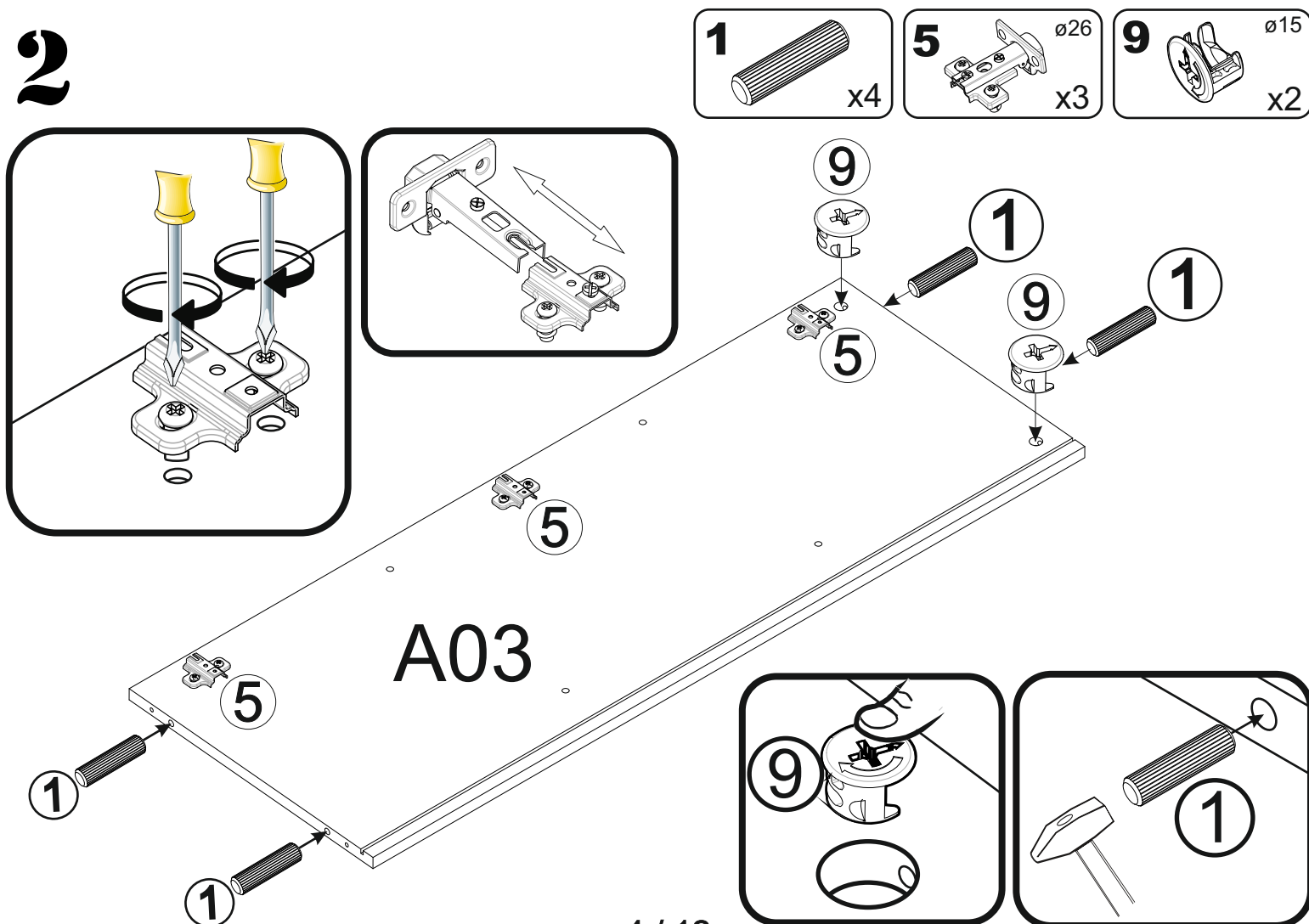

3

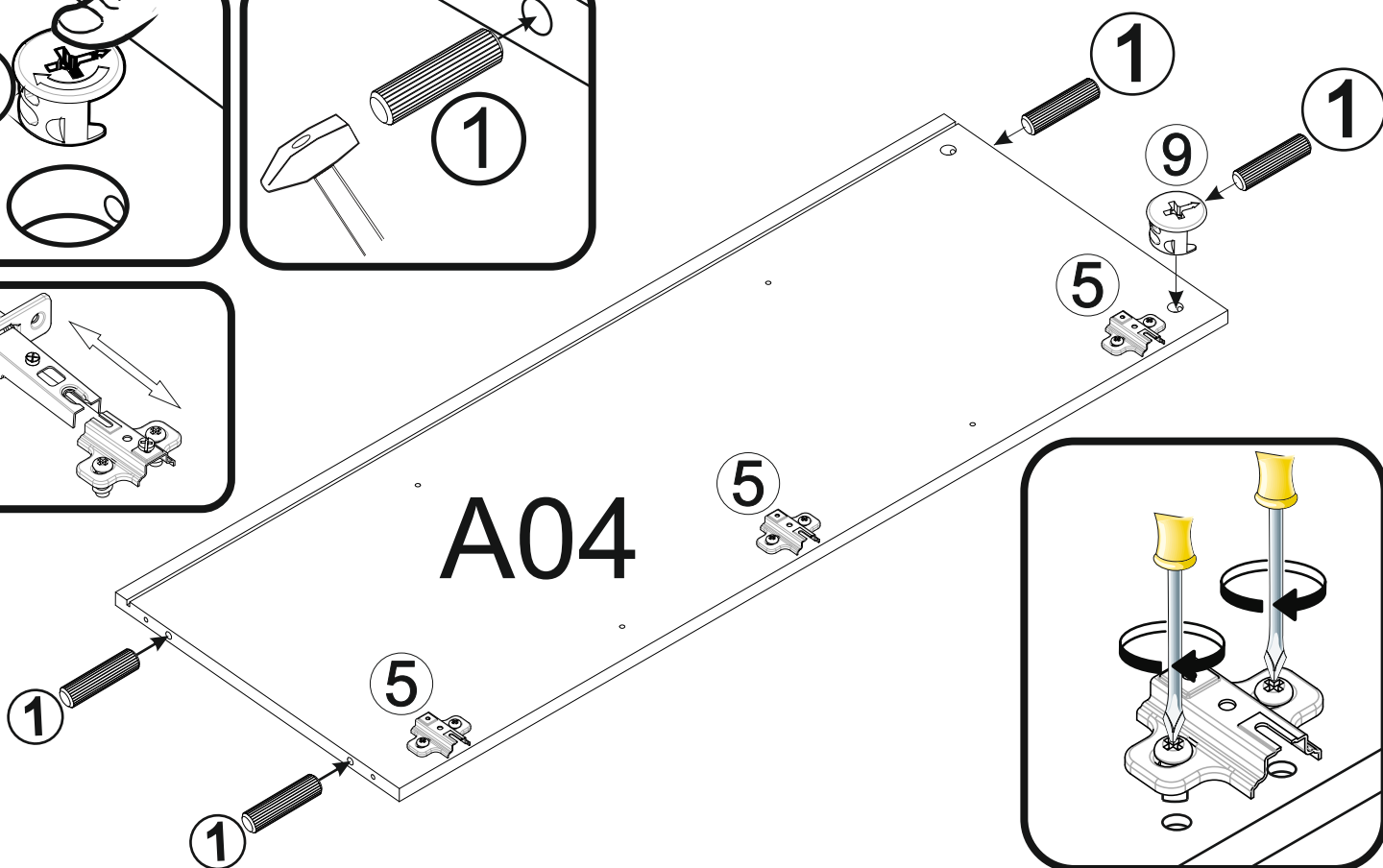
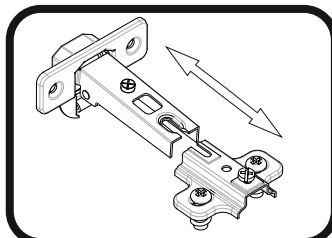
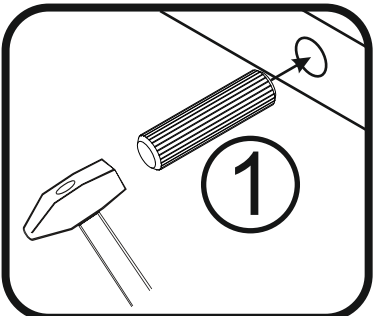
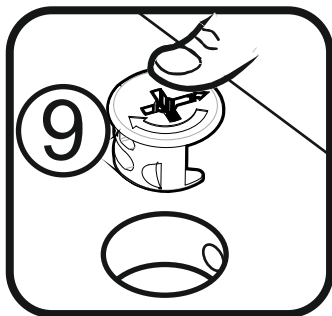
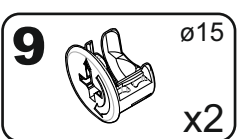
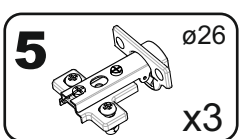
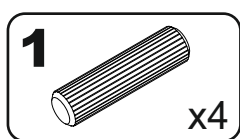

4

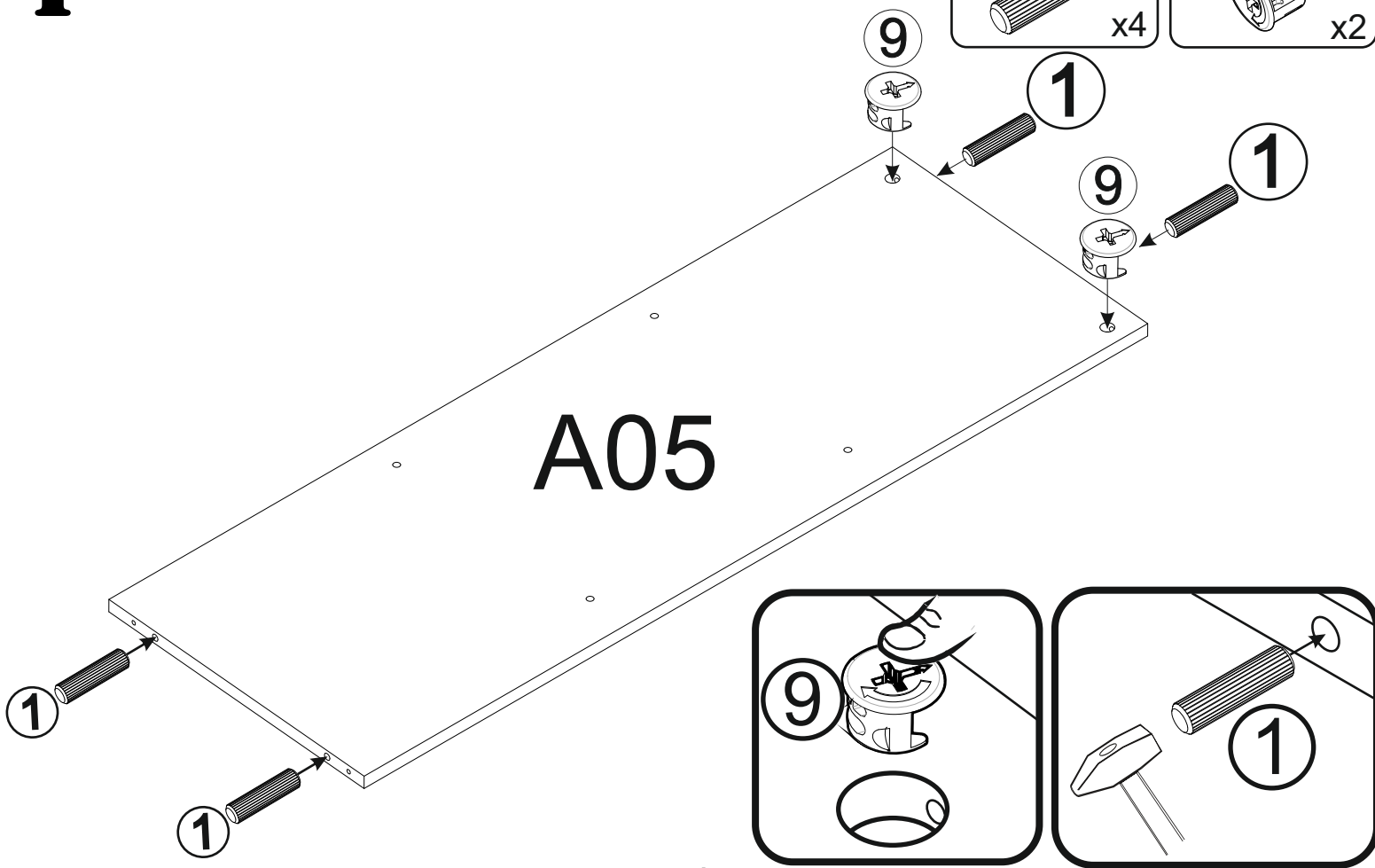
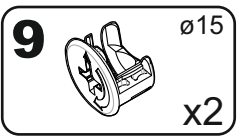
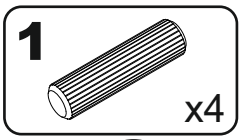

5

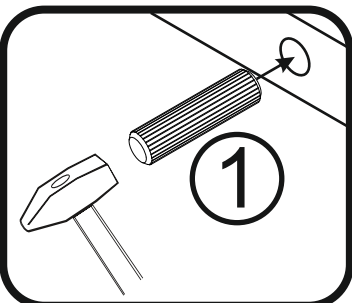
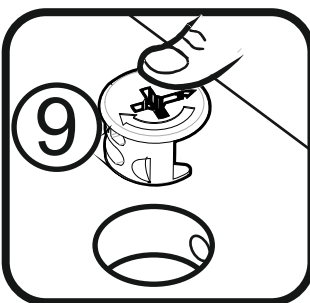
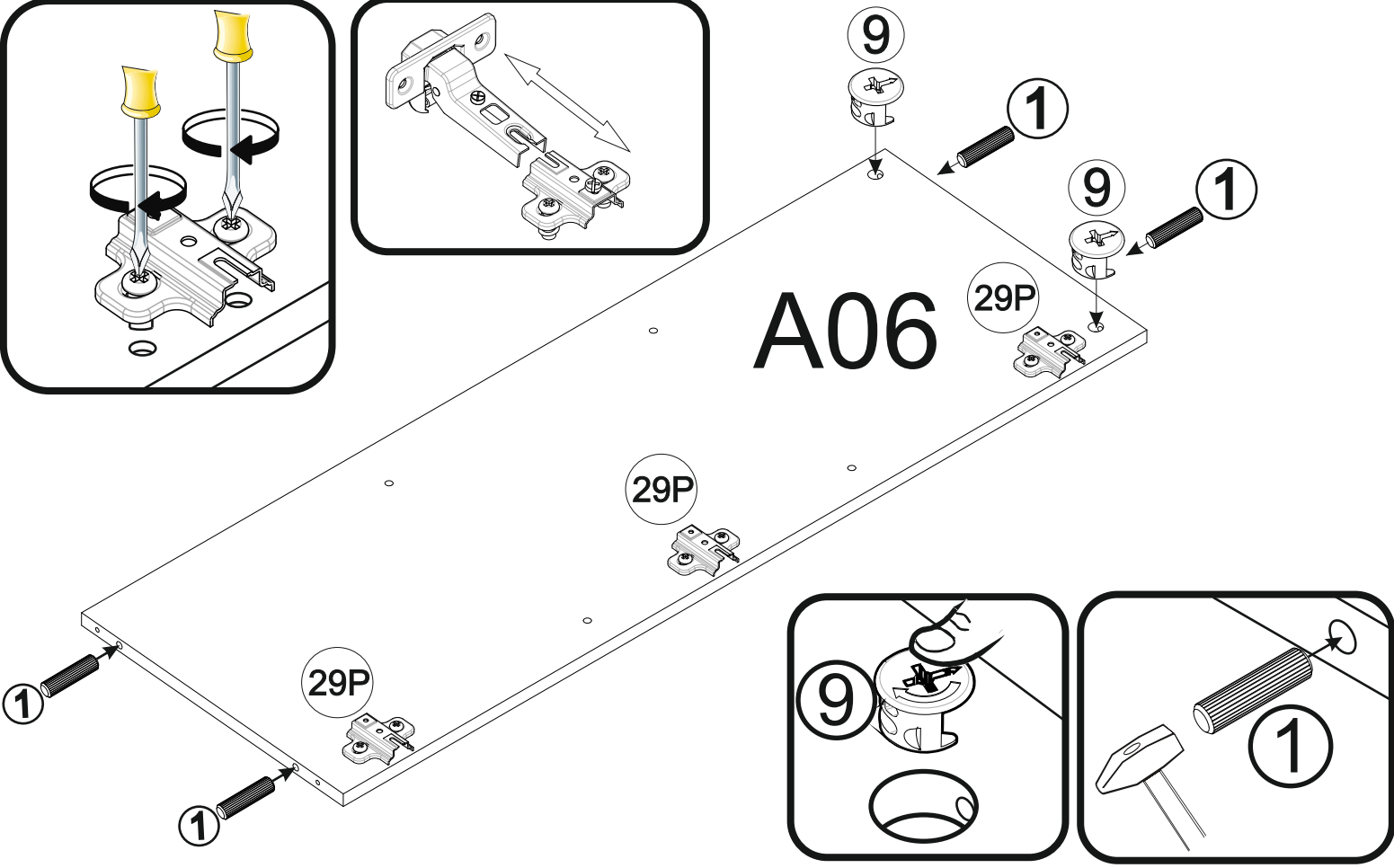
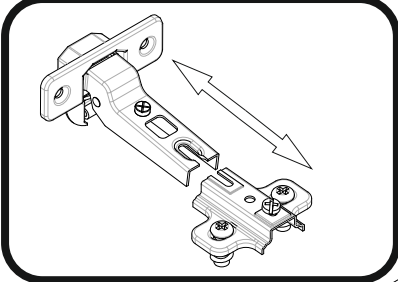
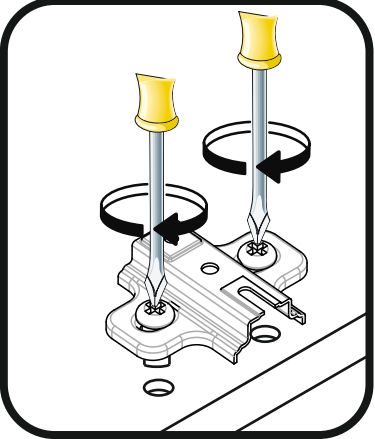
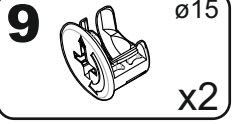
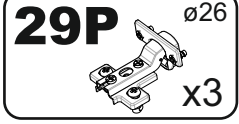
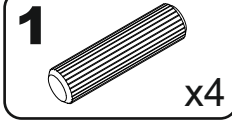

6

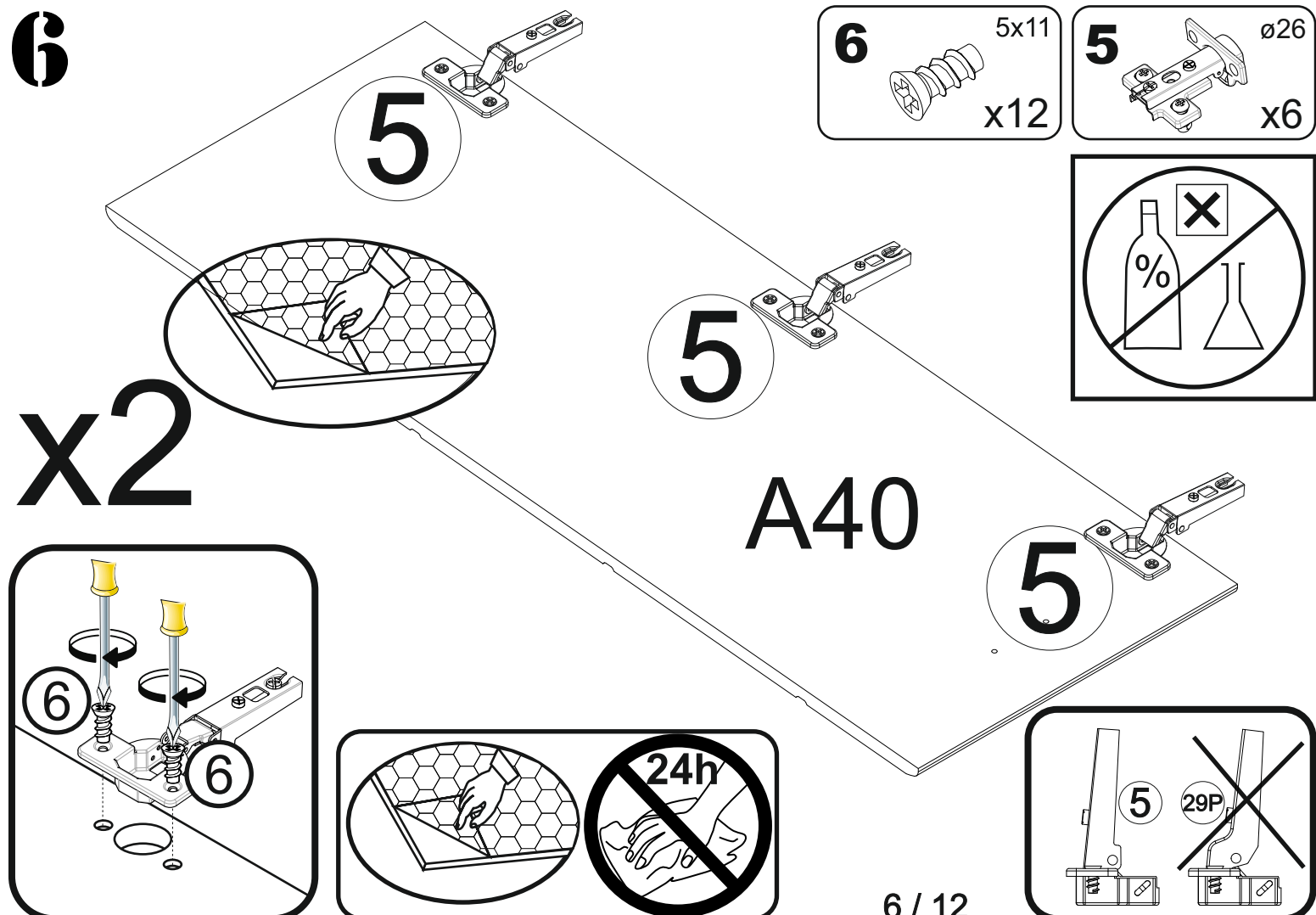
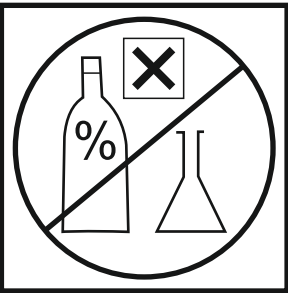
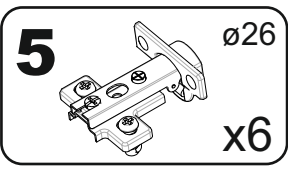
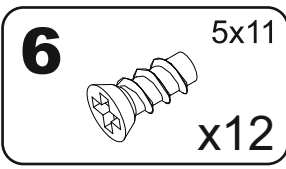

x2

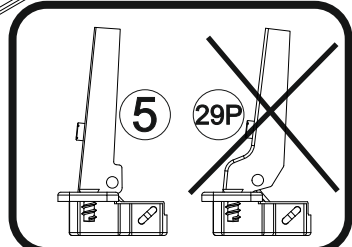
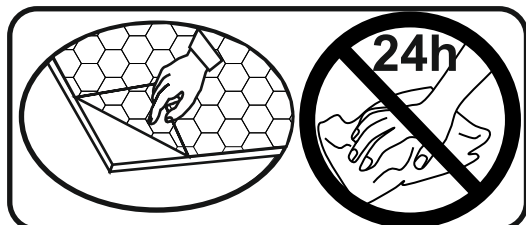
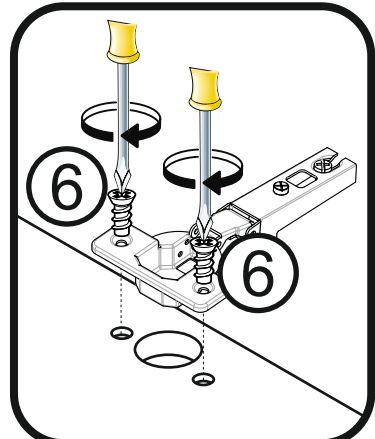

7

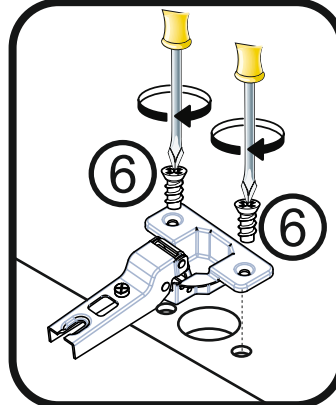
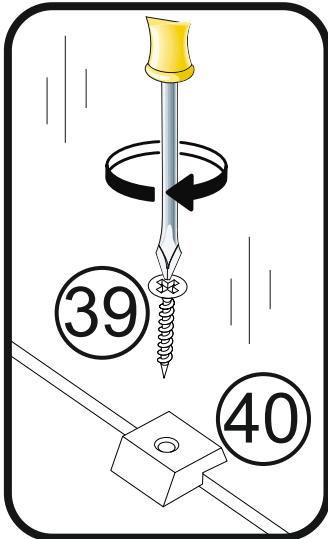
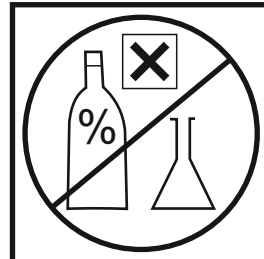
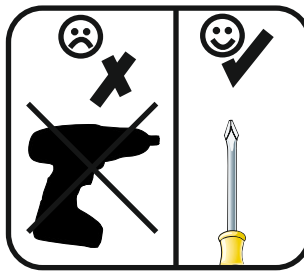
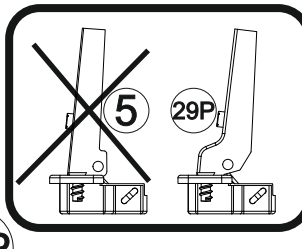
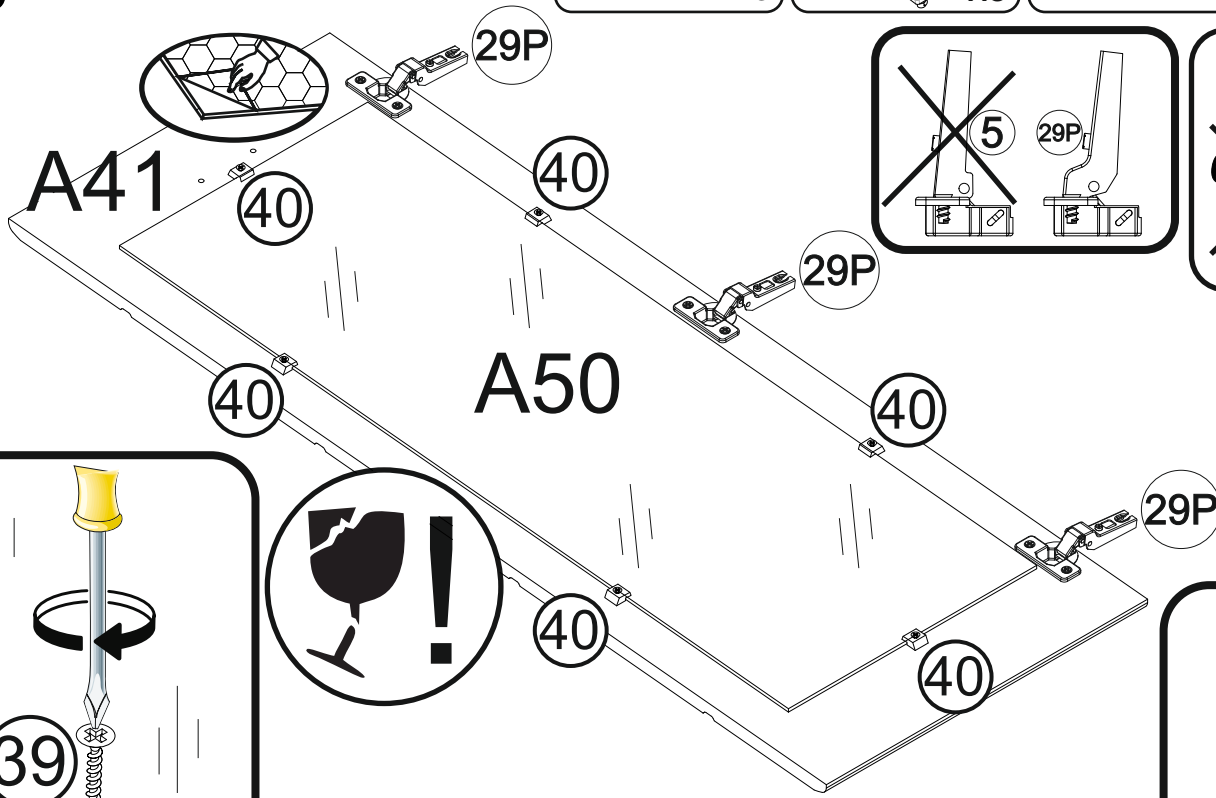
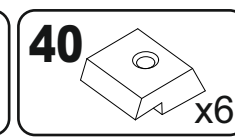
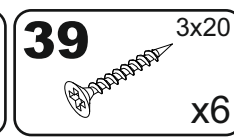
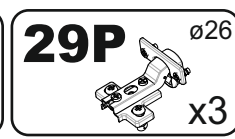
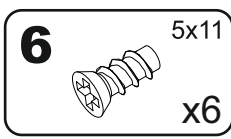

8

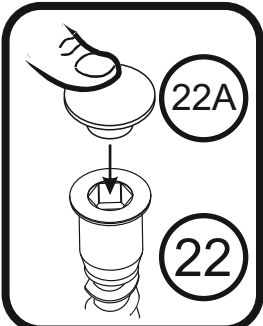
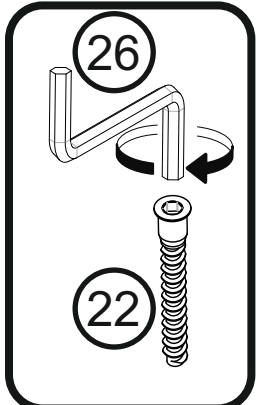
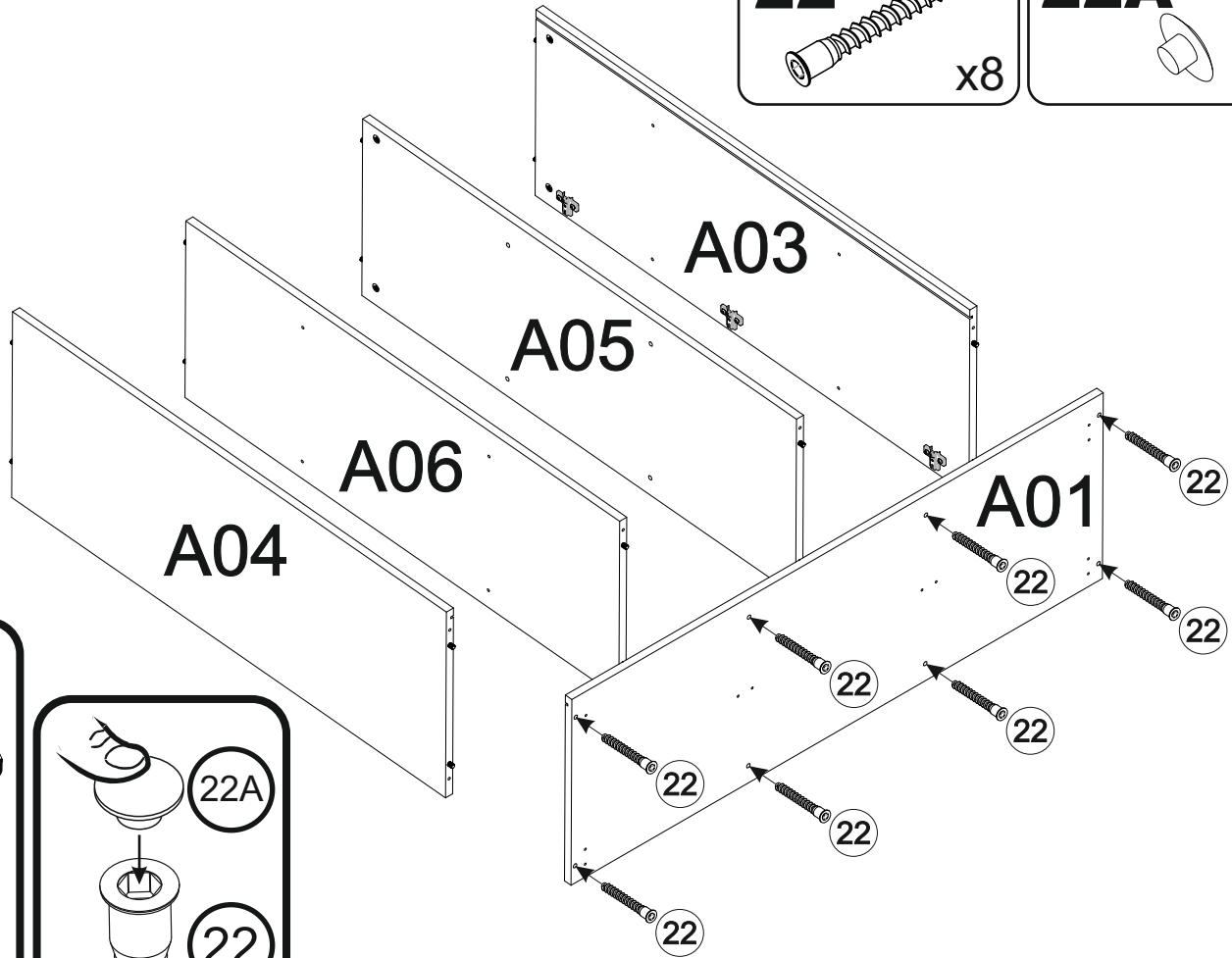
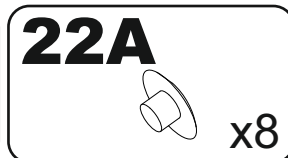
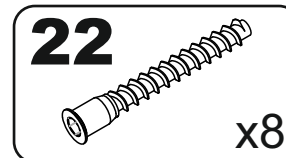

9

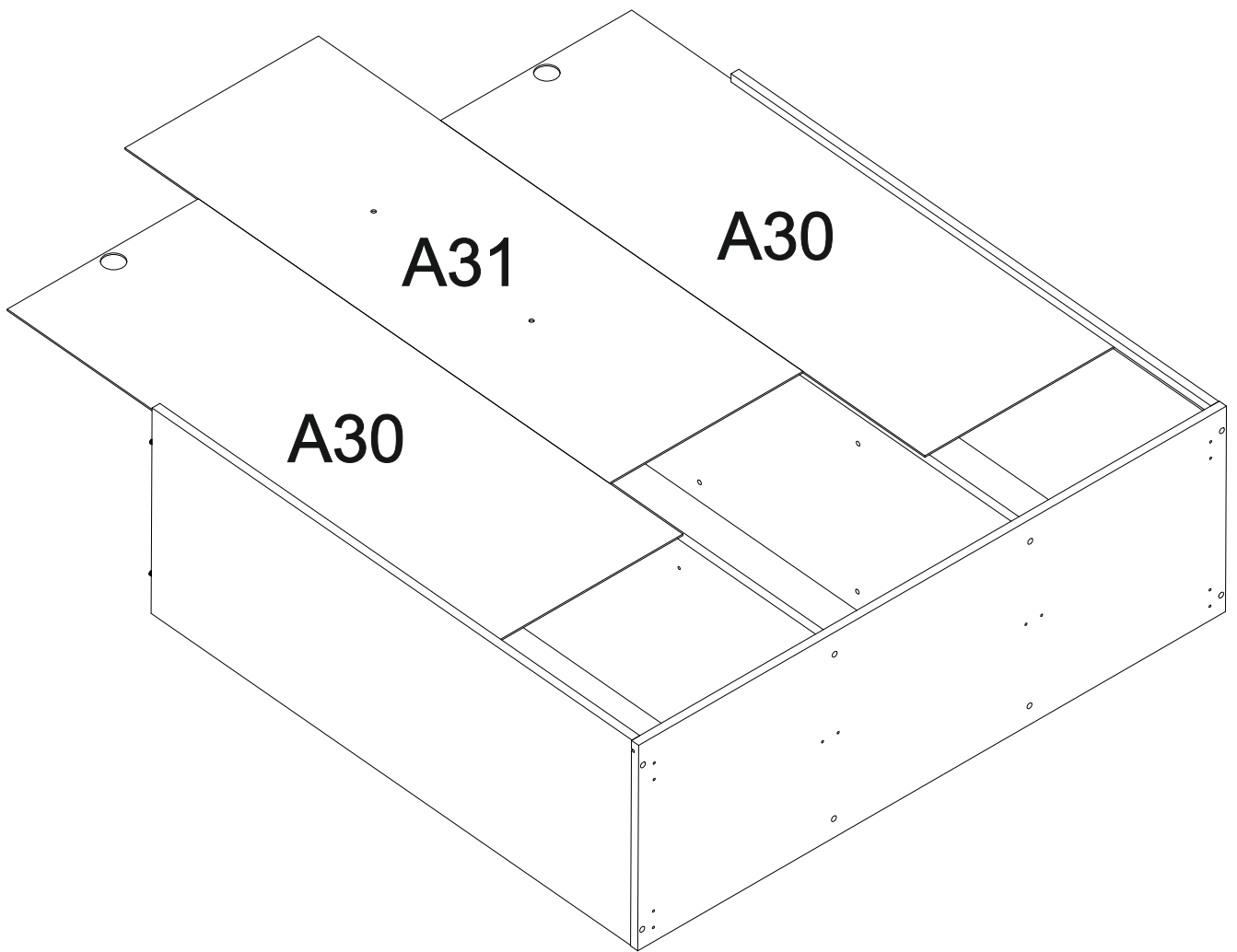

10

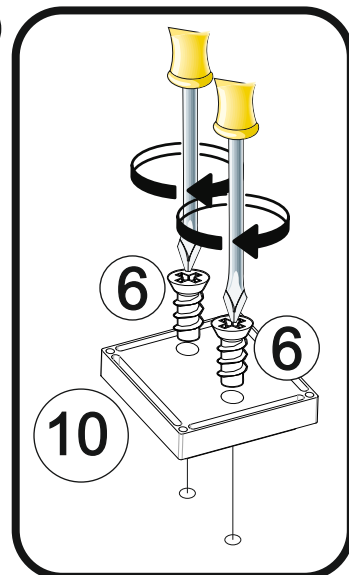
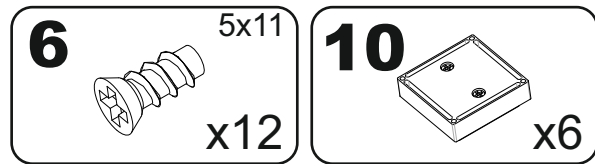
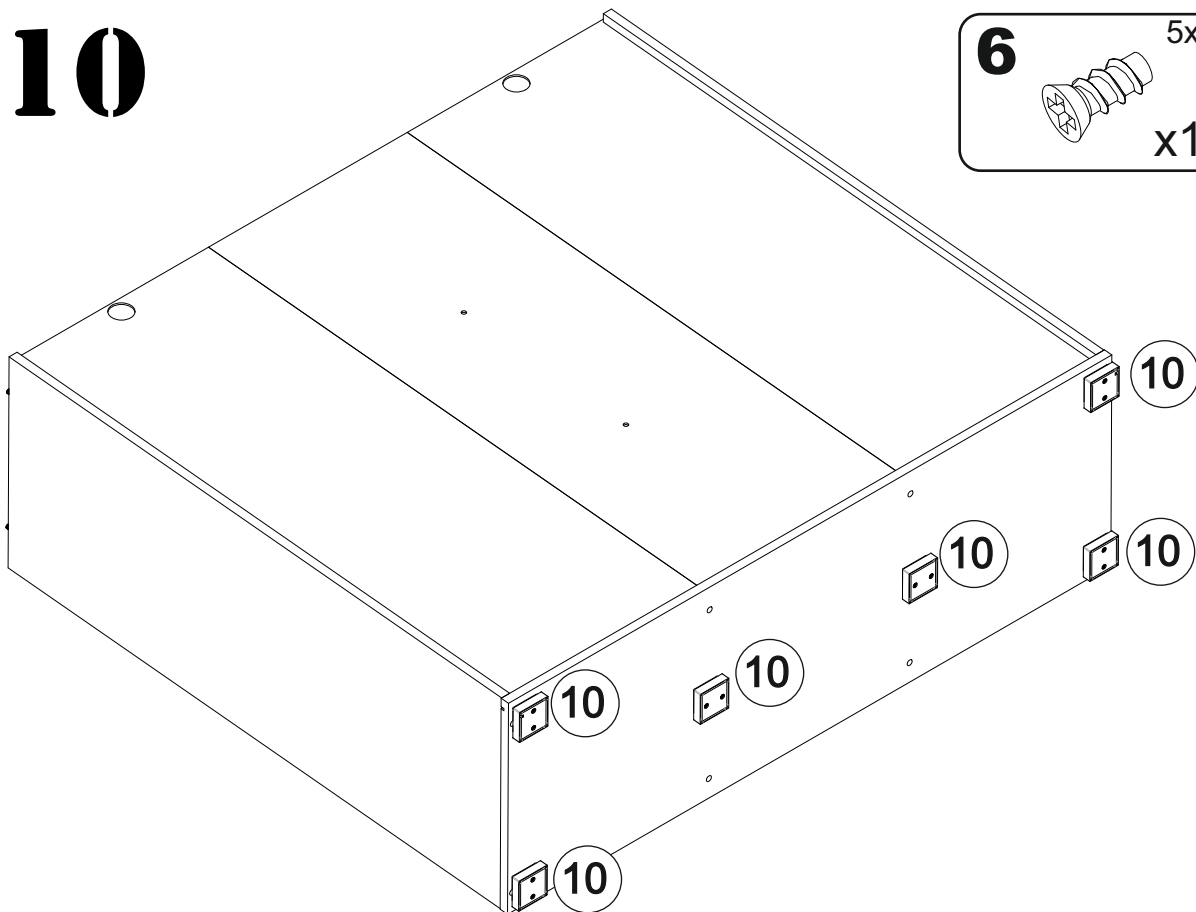

11

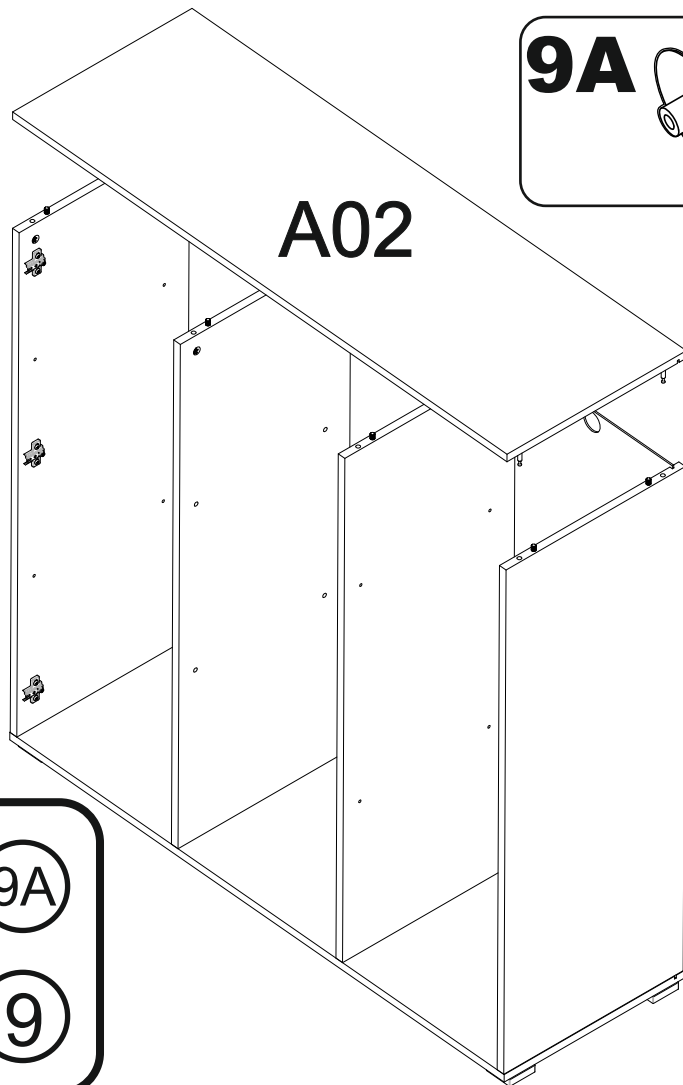
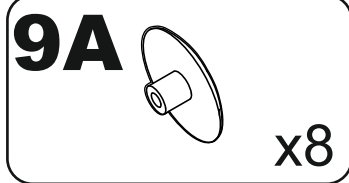

A02

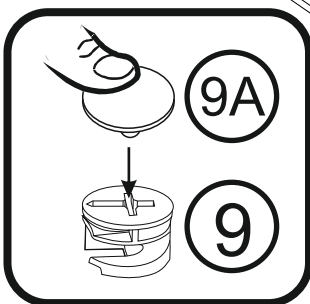
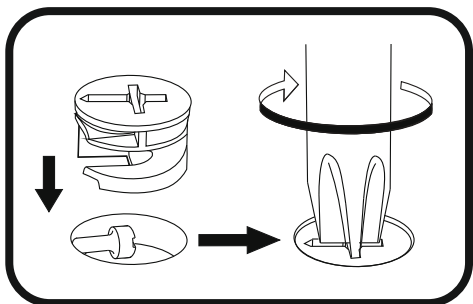

12

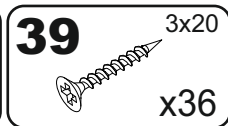
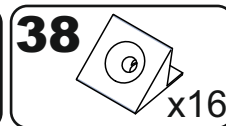
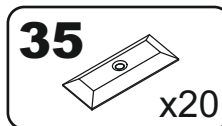

A=B

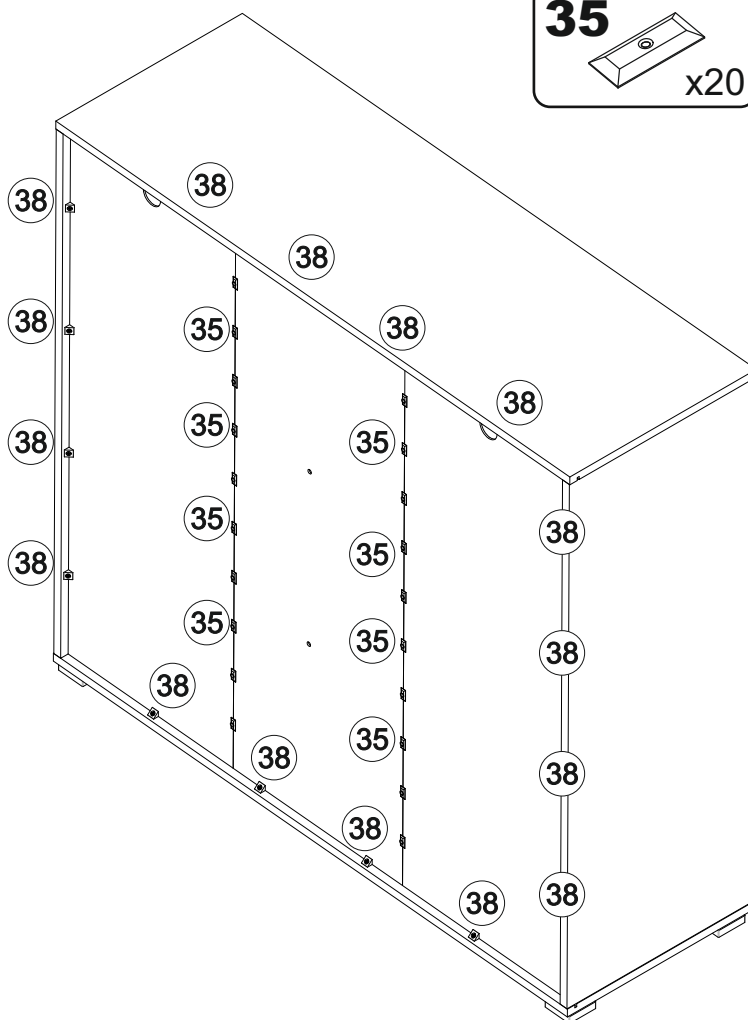
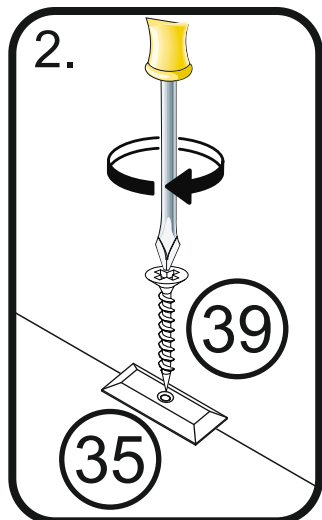
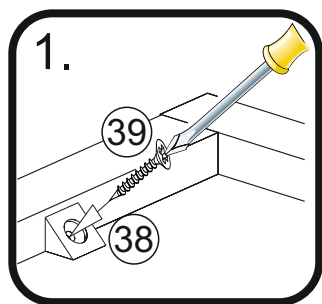
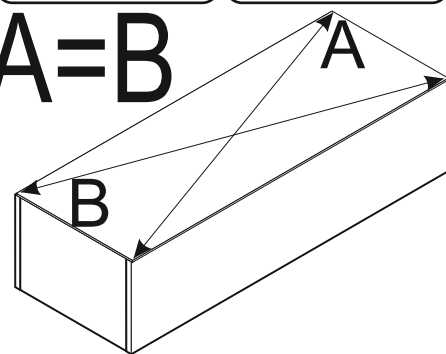

13

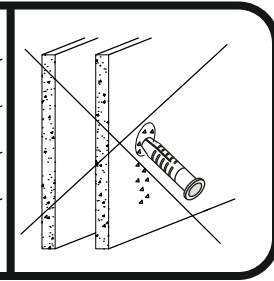
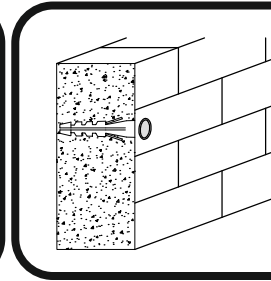
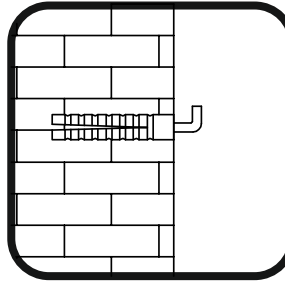
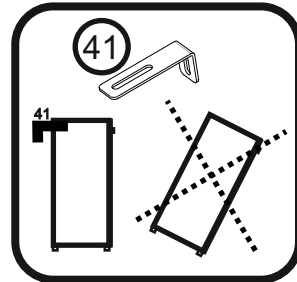
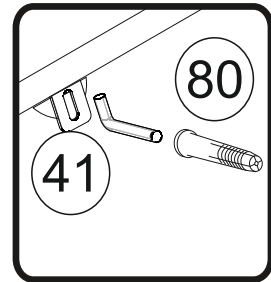
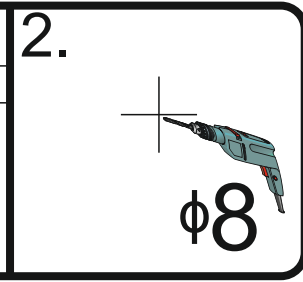
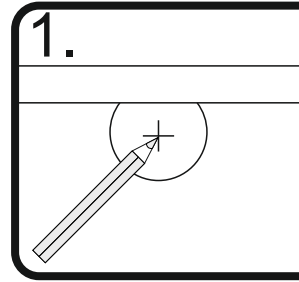
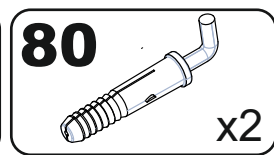
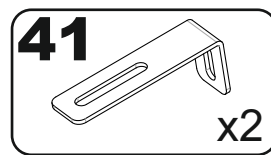
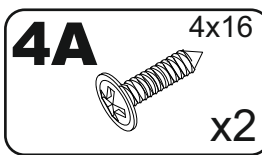
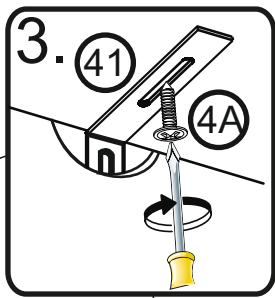
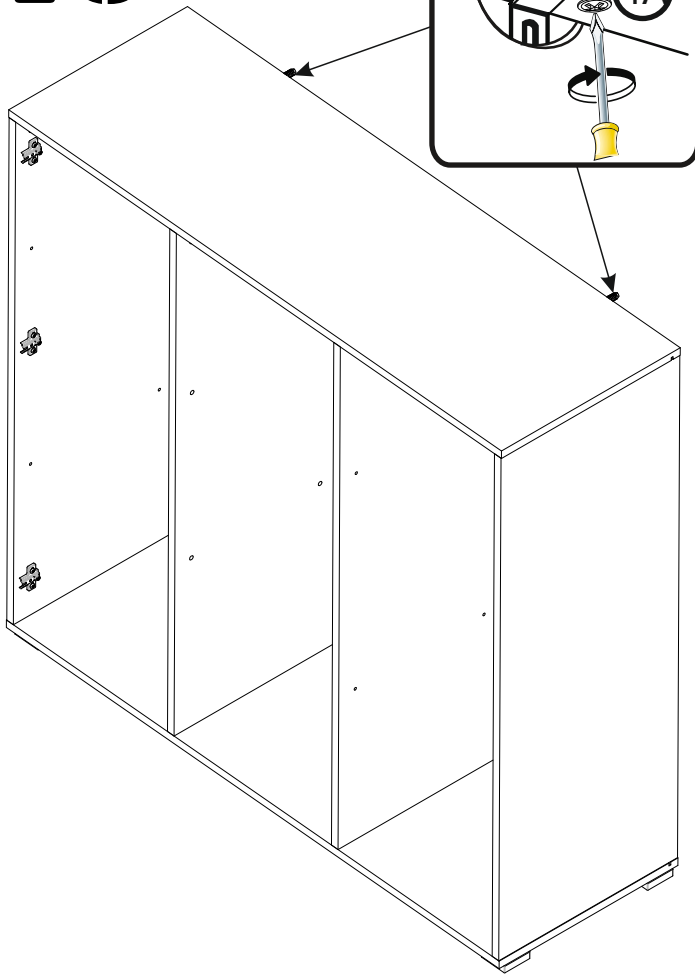

14

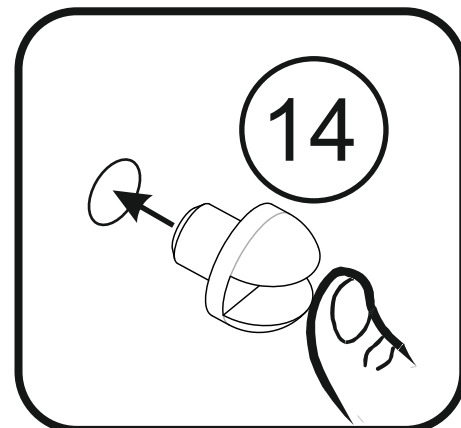
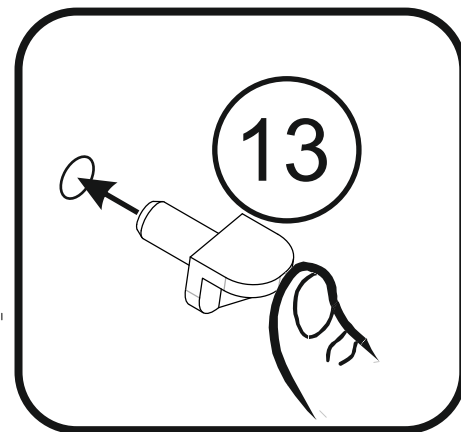
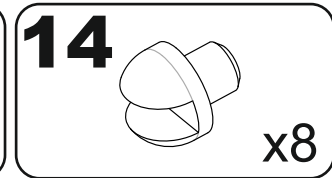
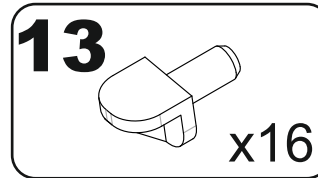
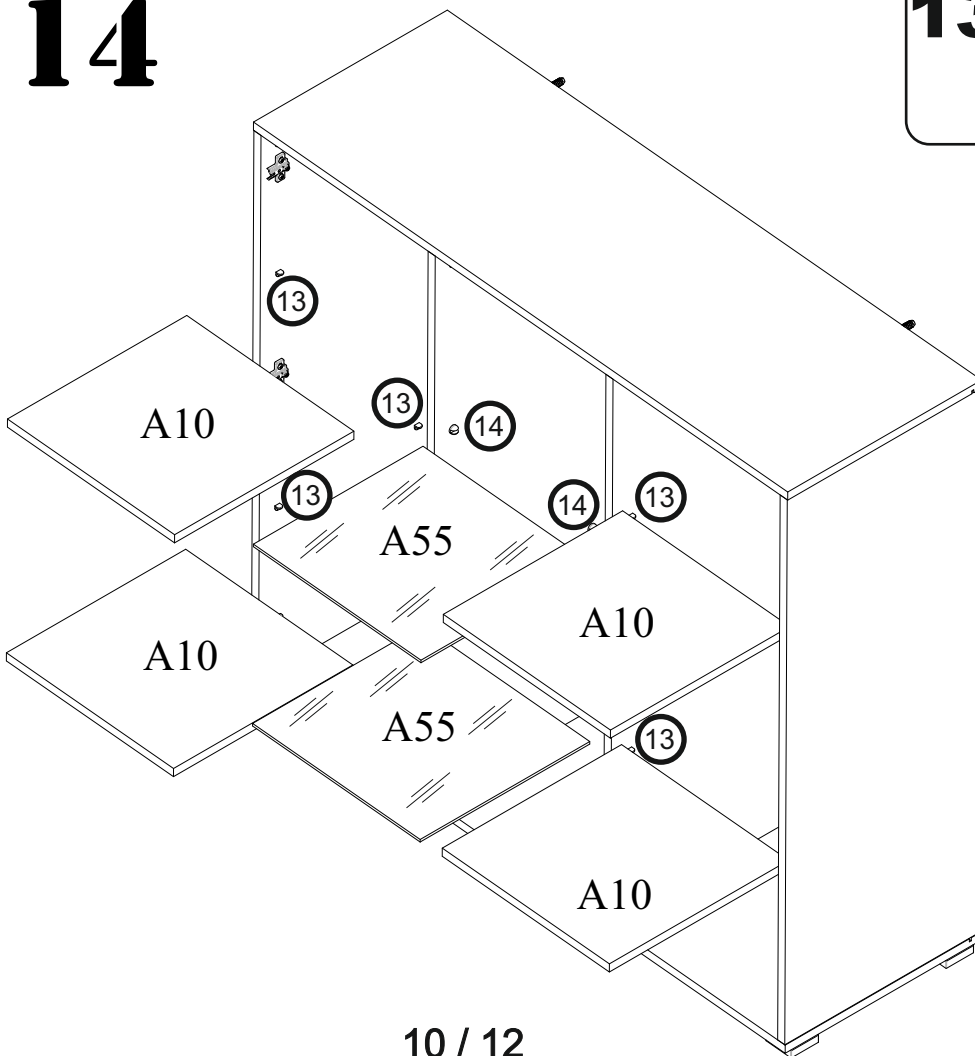

15

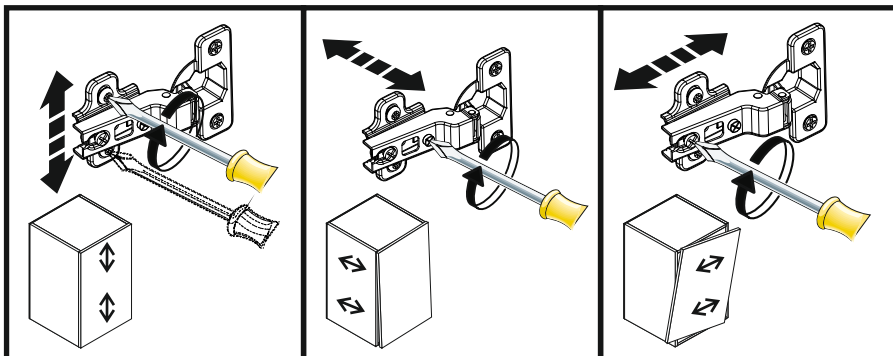
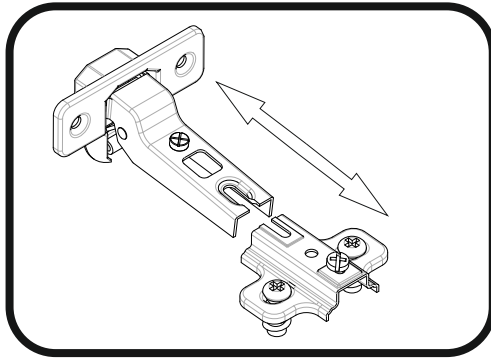
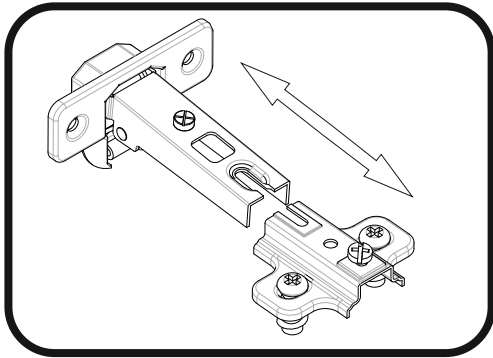
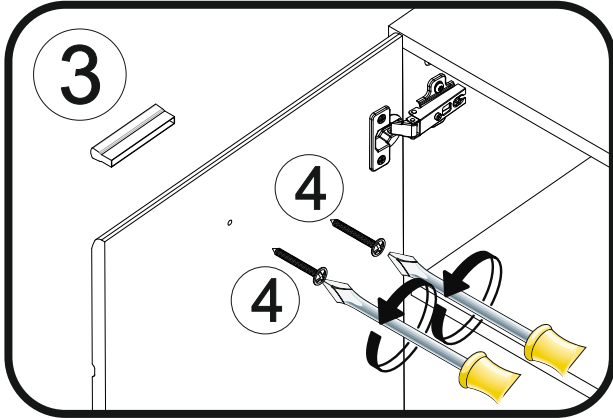
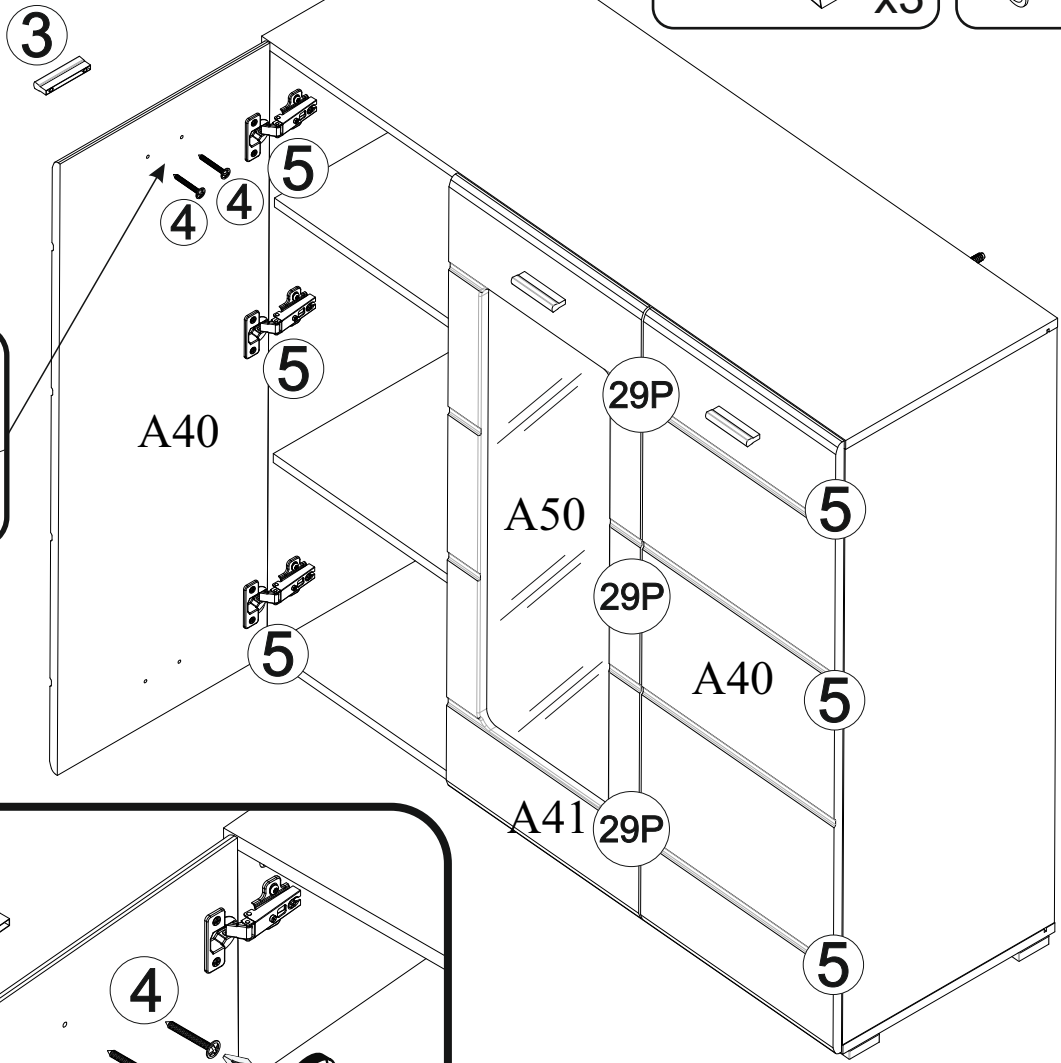
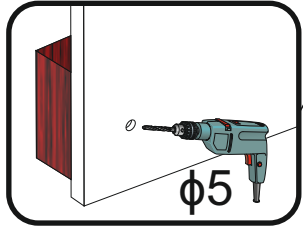
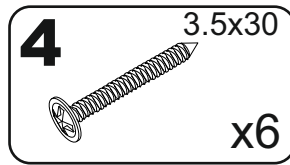
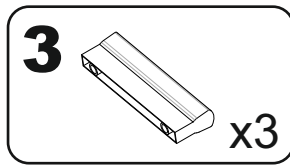

835155

FS-2835-30D-CW

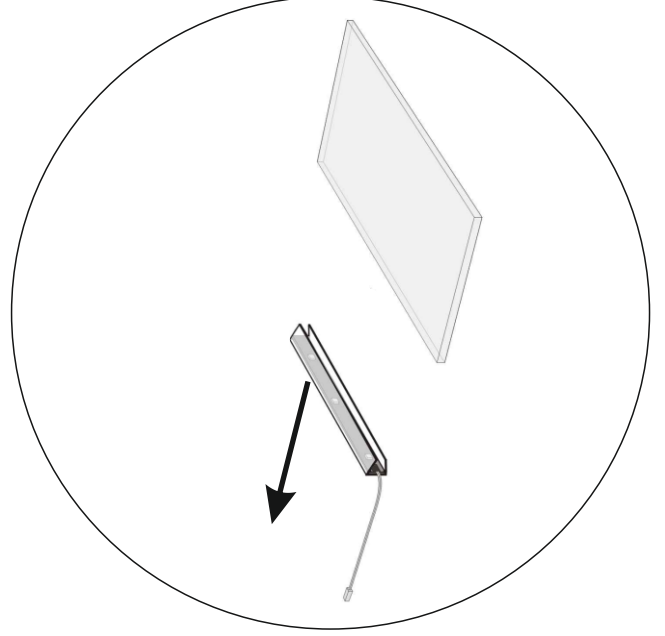
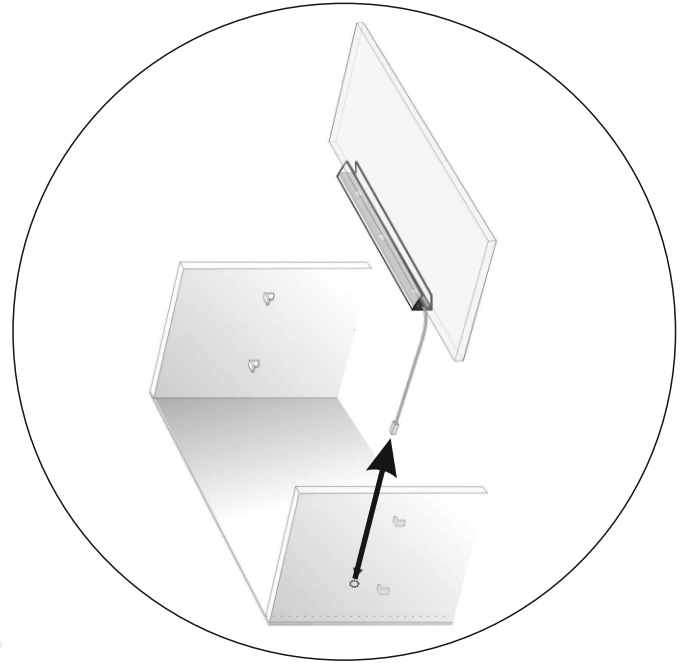
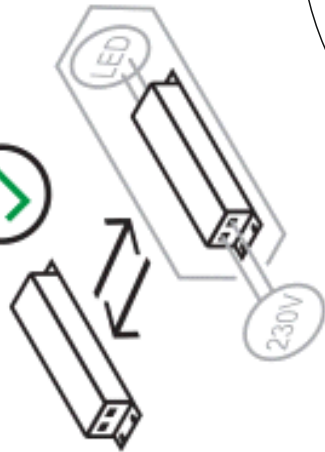
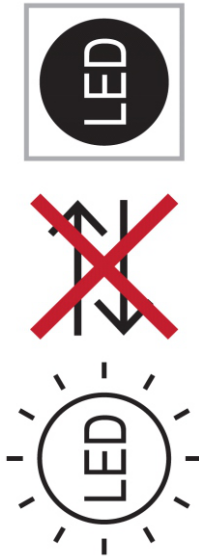

PL- Ten produkt zawiera źródła światła o klasie efektywności energetycznej „E”	DE- Diese Produkte enthalten Lichtquellen der Energieeffizienzklasse „E”	CS- Tento výrobek obsahuje světelný zdroj třídy energetické účinnosti „E”
DA- Dette produkt indeholder en lyskilde til energifølethedsklasse „E”	EL- Αυτό το προϊόν περιέχει μια πηγή φωταενης πηγής ενεργειακής απόδοσης „E”	EN- This product contains a light sources of energy efficiency class „E”
ES- Este producto contiene una fuente de luz de clase de eficiencia energética „E”	ET- See toode sisaldab efektiivsusklassi valgusallikat energia " E”	FI- Tämä tuote sisältää energiatehokkuusluokan valonlähteen „E”
FR- Ce produit contient des sources lumineuses de classe d'efficacité „E”	HU- Ez a termék energiatékonysági osztályú fényforrást tartalmaz „E”	IT- Questo prodotto contiene una sorgente luminosa di classe di efficienza energetica „E”
LT- Šiame gaminyje yra energijos vartojimo efektyvumo klasės šviesos šaltinis „E”	LV- Šis produkts satur gaismas avotu ar energoefektivitātes klasi „E”	RU- Этот продукт содержит источник света класса энергоэффективности „E”
PT- Este produto contém uma fonte de luz da classe de eficiência energética „E”	RO- Acest produs conține o sursă de lumină de clasă de eficiență energetică „E”	NL- Dit product bevat een lichtbron met energie - efficiëntieklasse „E”
SK- Tento výrobek obsahuje svetelný zdroj triedy energetickej účinnosti „E”	SLO- Ta izdelek vsebuje svetlobni vir razreda energijske učinkovitosti „E”	SV- Denna produkt innehåller en ljuskälla för energieffektivitetsklass „E”
TR- Bu ürün bir ışık kaynağı enerji verimliliği sınıfı içerir „E”	HR- Ovaj proizvod sadrži izvor svjetlosti razreda energetske učinkovitosti „E”	BG- Този продукт съдържа източник на светлина от клас на енергийна ефективност „E”